

DIGITAL KEYBOARD

PSR-I500

Owner's Manual

**Setting Up****Quick Guide****Reference****Appendix**

Thank you for purchasing this Yamaha Digital Keyboard!

The instrument is a portable keyboard with featuring a wide variety of sounds and functions.

We recommend that you read this manual carefully so that you can fully take advantage of the advanced and convenient functions of the instrument. We also recommend that you keep this manual in a safe and handy place for future reference.

Before using the instrument, be sure to read "PRECAUTIONS" on pages 5-7.

SPECIAL MESSAGE SECTION

This product utilizes batteries or an external power supply (adapter). DO NOT connect this product to any power supply or adapter other than one described in the manual, on the name plate, or specifically recommended by Yamaha.

WARNING: Do not place this product in a position where anyone could walk on, trip over, or roll anything over power or connecting cords of any kind. The use of an extension cord is not recommended! If you must use an extension cord, the minimum wire size for a 25' cord (or less) is 18 AWG. NOTE: The smaller the AWG number, the larger the current handling capacity. For longer extension cords, consult a local electrician.

This product should be used only with the components supplied or: a cart, rack, or stand that is recommended by Yamaha. If a cart, etc., is used, please observe all safety markings and instructions that accompany the accessory product.

SPECIFICATIONS SUBJECT TO CHANGE:

The information contained in this manual is believed to be correct at the time of printing. However, Yamaha reserves the right to change or modify any of the specifications without notice or obligation to update existing units.

This product, either alone or in combination with an amplifier and headphones or speaker/s, may be capable of producing sound levels that could cause permanent hearing loss. DO NOT operate for long periods of time at a high volume level or at a level that is uncomfortable. If you experience any hearing loss or ringing in the ears, you should consult an audiologist.

IMPORTANT: The louder the sound, the shorter the time period before damage occurs.

Some Yamaha products may have benches and / or accessory mounting fixtures that are either supplied with the product or as optional accessories. Some of these items are designed to be dealer assembled or installed. Please make sure that benches are stable and any optional fixtures (where applicable) are well secured BEFORE using.

Benches supplied by Yamaha are designed for seating only. No other uses are recommended.

NOTICE:

Service charges incurred due to a lack of knowledge relating to how a function or effect works (when the unit is operating as designed) are not covered by the manufacturer's warranty, and are therefore the owners responsibility. Please study this manual carefully and consult your dealer before requesting service.

ENVIRONMENTAL ISSUES:

Yamaha strives to produce products that are both user safe and environmentally friendly. We sincerely believe that our products and the production methods used to produce them, meet these goals. In keeping with both the letter and the spirit of the law, we want you to be aware of the following:

Battery Notice:

This product MAY contain a small non-rechargeable battery which (if applicable) is soldered in place. The average life span of this type of battery is approximately five years. When replacement becomes necessary, contact a qualified service representative to perform the replacement.

This product may also use "household" type batteries. Some of these may be rechargeable. Make sure that the battery being charged is a rechargeable type and that the charger is intended for the battery being charged.

When installing batteries, never mix old batteries with new ones, and never mix different types of batteries. Batteries MUST be installed correctly. Mismatches or incorrect installation may result in overheating and battery case rupture.

Warning:

Do not attempt to disassemble, or incinerate any battery. Keep all batteries away from children. Dispose of used batteries promptly and as regulated by the laws in your area. Note: Check with any retailer of household type batteries in your area for battery disposal information.

Disposal Notice:

Should this product become damaged beyond repair, or for some reason its useful life is considered to be at an end, please observe all local, state, and federal regulations that relate to the disposal of products that contain lead, batteries, plastics, etc. If your dealer is unable to assist you, please contact Yamaha directly.

NAME PLATE LOCATION:

The name plate is located on the bottom of the product. The model number, serial number, power requirements, etc., are located on this plate. You should record the model number, serial number, and the date of purchase in the spaces provided below and retain this manual as a permanent record of your purchase.

Model _____

Serial No. _____

Purchase Date _____

PLEASE KEEP THIS MANUAL

92-BP (bottom)

COMPLIANCE INFORMATION STATEMENT (Supplier's declaration of conformity procedure)

Responsible Party : Yamaha Corporation of America
Address : 6600 Orangethorpe Ave., Buena Park, Calif. 90620
Telephone : 714-522-9011
Type of Equipment : Digital Keyboard
Model Name : PSR-I500

This device complies with Part 15 of the FCC Rules.

Operation is subject to the following two conditions:

- 1) this device may not cause harmful interference, and
- 2) this device must accept any interference received including interference that may cause undesired operation.

* This applies only to products distributed by Yamaha Corporation of America. (FCC SD05)

FCC INFORMATION (U.S.A.)

1. IMPORTANT NOTICE: DO NOT MODIFY THIS UNIT!

This product, when installed as indicated in the instructions contained in this manual, meets FCC requirements. Modifications not expressly approved by Yamaha may void your authority, granted by the FCC, to use the product.

2. IMPORTANT: When connecting this product to accessories and/or another product use only high quality shielded cables. Cable/s supplied with this product **MUST** be used. Follow all installation instructions. Failure to follow instructions could void your FCC authorization to use this product in the USA.

3. NOTE: This product has been tested and found to comply with the requirements listed in FCC Regulations, Part 15 for Class "B" digital devices. Compliance with these requirements provides a reasonable level of assurance that your use of this product in a residential environment will not result in harmful interference with other electronic devices. This equipment generates/uses radio frequencies and, if not installed and used according to the instructions found in the users manual, may cause interference harmful to the operation of other electronic devices. Compliance with FCC regulations does not guarantee

that interference will not occur in all installations. If this product is found to be the source of interference, which can be determined by turning the unit "OFF" and "ON", please try to eliminate the problem by using one of the following measures:

Relocate either this product or the device that is being affected by the interference.

Utilize power outlets that are on different branch (circuit breaker or fuse) circuits or install AC line filter/s.

In the case of radio or TV interference, relocate/reorient the antenna. If the antenna lead-in is 300 ohm ribbon lead, change the lead-in to co-axial type cable.

If these corrective measures do not produce satisfactory results, please contact the local retailer authorized to distribute this type of product. If you can not locate the appropriate retailer, please contact Yamaha Corporation of America, Electronic Service Division, 6600 Orangethorpe Ave, Buena Park, CA90620

The above statements apply **ONLY** to those products distributed by Yamaha Corporation of America or its subsidiaries.

* This applies only to products distributed by YAMAHA CORPORATION OF AMERICA.

(class B)

The model number, serial number, power requirements, etc., may be found on or near the name plate, which is at the bottom of the unit. You should note this serial number in the space provided below and retain this manual as a permanent record of your purchase to aid identification in the event of theft.

Model No.

Serial No.

(bottom_en_01)

For AC adaptor

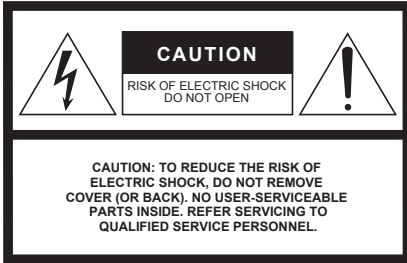

Explanation of Graphical Symbols



The lightning flash with arrowhead symbol within an equilateral triangle is intended to alert the user to the presence of uninsulated “dangerous voltage” within the product’s enclosure that may be of sufficient magnitude to constitute a risk of electric shock to persons.



The exclamation point within an equilateral triangle is intended to alert the user to the presence of important operating and maintenance (servicing) instructions in the literature accompanying the product.

IMPORTANT SAFETY INSTRUCTIONS

- 1 Read these instructions.
- 2 Keep these instructions.
- 3 Heed all warnings.
- 4 Follow all instructions.
- 5 Do not use this apparatus near water.
- 6 Clean only with dry cloth.
- 7 Do not block any ventilation openings. Install in accordance with the manufacturer’s instructions.
- 8 Do not install near any heat sources such as radiators, heat registers, stoves, or other apparatus (including amplifiers) that produce heat.
- 9 Do not defeat the safety purpose of the polarized or grounding-type plug. A polarized plug has two blades with one wider than the other. A grounding type plug has two blades and a third grounding prong. The wide blade or the third prong are provided for your safety. If the provided plug does not fit into your outlet, consult an electrician for replacement of the obsolete outlet.
- 10 Protect the power cord from being walked on or pinched particularly at plugs, convenience receptacles, and the point where they exit from the apparatus.

- 11 Only use attachments/accessories specified by the manufacturer.

- 12 Use only with the cart, stand, tripod, bracket, or table specified by the manufacturer, or sold with the apparatus. When a cart is used, use caution when moving the cart/apparatus combination to avoid injury from tip-over.



- 13 Unplug this apparatus during lightning storms or when unused for long periods of time.
- 14 Refer all servicing to qualified service personnel. Servicing is required when the apparatus has been damaged in any way, such as power-supply cord or plug is damaged, liquid has been spilled or objects have fallen into the apparatus, the apparatus has been exposed to rain or moisture, does not operate normally, or has been dropped.

WARNING

TO REDUCE THE RISK OF FIRE OR ELECTRIC SHOCK, DO NOT EXPOSE THIS APPARATUS TO RAIN OR MOISTURE.

(UL60065_03)

PRECAUTIONS

PLEASE READ CAREFULLY BEFORE PROCEEDING

Please keep this manual in a safe and handy place for future reference.

For AC adaptor



WARNING

- This AC adaptor is designed for use with only Yamaha electronic instruments. Do not use for any other purpose.
- Indoor use only. Do not use in any wet environments.



CAUTION

- When setting up, make sure that the AC outlet is easily accessible. If some trouble or malfunction occurs, immediately turn off the power switch of the instrument and disconnect the AC adaptor from the outlet. When the AC adaptor is connected to the AC outlet, keep in mind that electricity is flowing at the minimum level, even if the power switch is turned off. When you are not using the instrument for a long time, make sure to unplug the power cord from the wall AC outlet.

For PSR-I500



WARNING

Always follow the basic precautions listed below to avoid the possibility of serious injury or even death from electrical shock, short-circuiting, damages, fire or other hazards. These precautions include, but are not limited to, the following:

Power supply/AC adaptor

- Do not place the power cord near heat sources such as heaters or radiators. Also, do not excessively bend or otherwise damage the cord, or place heavy objects on it.
- Only use the voltage specified as correct for the instrument. The required voltage is printed on the name plate of the instrument.
- Use the specified adaptor (page 81) only. Using the wrong adaptor can result in damage to the instrument or overheating.
- Use only the supplied power cord/plug.
- Check the electric plug periodically and remove any dirt or dust which may have accumulated on it.

Do not open

- This instrument contains no user-serviceable parts. Do not attempt to disassemble or modify the internal components in any way. If it should appear to be malfunctioning, discontinue use immediately and have it inspected by qualified Yamaha service personnel.

Water warning

- Do not expose the instrument to rain, use it near water or in damp or wet conditions, or place on it any containers (such as vases, bottles or glasses) containing liquids which might spill into any openings. If any liquid such as water seeps into the instrument, turn off the power immediately and unplug the power cord from the AC outlet. Then have the instrument inspected by qualified Yamaha service personnel.
- Never insert or remove an electric plug with wet hands.

Fire warning

- Do not put burning items, such as candles, on the unit. A burning item may fall over and cause a fire.

Battery

- Follow the precautions below. Failure to do so might result in explosion, fire, overheating or battery fluid leakage.
 - Do not tamper with or disassemble batteries.
 - Do not dispose of batteries in fire.
 - Do not attempt to recharge batteries that are not designed to be charged.
 - Keep the batteries separate from metallic objects such as necklaces, hairpins, coins, and keys.
 - Use the specified battery type (page 81) only.
 - Use new batteries, all of which are the same type, same model, and made by the same manufacturer.
 - Always make sure all batteries are inserted in conformity with the +/- polarity markings.
 - When the batteries run out, or if the instrument is not to be used for a long time, remove the batteries from the instrument.
 - When using Ni-MH batteries, follow the instructions that came with the batteries. Use only the specified charger device when charging.

- Keep batteries away from small children who might accidentally swallow them.
- If the batteries do leak, avoid contact with the leaked fluid. If the battery fluid should come in contact with your eyes, mouth, or skin, wash immediately with water and consult a doctor. Battery fluid is corrosive and may possibly cause loss of sight or chemical burns.

If you notice any abnormality

- When one of the following problems occur, immediately turn off the power switch and disconnect the electric plug from the outlet. (If you are using batteries, remove all batteries from the instrument.) Then have the device inspected by Yamaha service personnel.
 - The power cord or plug becomes frayed or damaged.
 - It emits unusual smells or smoke.
 - Some object has been dropped into the instrument.
 - There is a sudden loss of sound during use of the instrument.



CAUTION

Always follow the basic precautions listed below to avoid the possibility of physical injury to you or others, or damage to the instrument or other property. These precautions include, but are not limited to, the following:

Power supply/AC adaptor

- Do not connect the instrument to an electrical outlet using a multiple-connector. Doing so can result in lower sound quality, or possibly cause overheating in the outlet.
- When removing the electric plug from the instrument or an outlet, always hold the plug itself and not the cord. Pulling by the cord can damage it.
- Remove the electric plug from the outlet when the instrument is not to be used for extended periods of time, or during electrical storms.

Location

- Do not place the instrument in an unstable position where it might accidentally fall over.
- Before moving the instrument, remove all connected cables, to prevent damage to the cables or injury to anyone who might trip over them.
- When setting up the product, make sure that the AC outlet you are using is easily accessible. If some trouble or malfunction occurs, immediately turn off the power switch and disconnect the plug from the outlet. Even when the power switch is turned off, electricity is still flowing to the product at the minimum level. When you are not using the product for a long time, make sure to unplug the power cord from the wall AC outlet.

- Use only the stand/rack specified for the instrument. When attaching it, use the provided screws only. Failure to do so could cause damage to the internal components or result in the instrument falling over.

Connections

- Before connecting the instrument to other electronic components, turn off the power for all components. Before turning the power on or off for all components, set all volume levels to minimum.
- Be sure to set the volumes of all components at their minimum levels and gradually raise the volume controls while playing the instrument to set the desired listening level.

Handling caution

- Do not insert a finger or hand in any gaps on the instrument.
- Never insert or drop paper, metallic, or other objects into the gaps on the panel or keyboard. This could cause physical injury to you or others, damage to the instrument or other property, or operational failure.
- Do not rest your weight on, or place heavy objects on the instrument, and do not use excessive force on the buttons, switches or connectors.

- Do not use the instrument/device or headphones for a long period of time at a high or uncomfortable volume level, since this can cause permanent hearing loss. If you experience any hearing loss or ringing in the ears, consult a physician.

Yamaha cannot be held responsible for damage caused by improper use or modifications to the instrument, or data that is lost or destroyed.

Always turn the power off when the instrument is not in use.

Even when the [] (Standby/On) switch is in standby status (display is off), electricity is still flowing to the instrument at the minimum level.

When you are not using the instrument for a long time, make sure you unplug the power cord from the wall AC outlet.

Make sure to discard used batteries according to local regulations.

DMI-5 3/3

NOTICE

To avoid the possibility of malfunction/ damage to the product, damage to data, or damage to other property, follow the notices below.

■ Handling

- Do not use the instrument in the vicinity of a TV, radio, stereo equipment, mobile phone, or other electric devices. Otherwise, the instrument, TV, or radio may generate noise. When you use the instrument along with an application on your iPad, iPhone or iPod touch, we recommend that you set “Airplane Mode” to “ON” on that device in order to avoid noise caused by communication.
- Do not expose the instrument to excessive dust or vibrations, or extreme cold or heat (such as in direct sunlight, near a heater, or in a car during the day) to prevent the possibility of panel discoloration, damage to the internal components or unstable operation. (Verified operating temperature range: 5° – 40°C, or 41° – 104°F.)
- Do not place vinyl, plastic or rubber objects on the instrument, since this might discolor the panel or keyboard.

■ Maintenance

- When cleaning the instrument, use a soft cloth. Do not use paint thinners, solvents, alcohol, cleaning fluids, or chemical-impregnated wiping cloths.

■ Saving data

- Some of the data of this instrument (page 48) are retained when the power is turned off. However, the saved data may be lost due to some failure, an operation mistake, etc. Save your important data onto USB flash drive/an external device such as a computer (pages 47, 73). Before using a USB flash drive, make sure to refer to page 71.
- To protect against data loss through USB flash drive damage, we recommend that you save your important data onto spare USB flash drive or an external device such as a computer as backup data.

Information

■ About copyrights

- Copying of the commercially available musical data including but not limited to MIDI data and/or audio data is strictly prohibited except for your personal use.
- This product incorporates and bundles contents in which Yamaha owns copyrights or with respect to which Yamaha has license to use others' copyrights. Due to copyright laws and other relevant laws, you are NOT allowed to distribute media in which these contents are saved or recorded and remain virtually the same or very similar to those in the product.
 - * The contents described above include a computer program, Accompaniment Style data, MIDI data, WAVE data, voice recording data, a score, score data, etc.
 - * You are allowed to distribute medium in which your performance or music production using these contents is recorded, and the permission of Yamaha Corporation is not required in such cases.

■ About functions/data bundled with the instrument

- Some of the preset songs and the songs that can be downloaded from the Yamaha website have been edited for length or arrangement, and may not be exactly the same as the original.

■ About this manual

- The illustrations and LCD screens as shown in this manual are for instructional purposes only, and may appear somewhat different from those on your instrument.
- Windows is a registered trademark of Microsoft® Corporation in the United States and other countries.
- iPhone, iPad, iPod touch and macOS are trademarks of Apple Inc., registered in the U.S. and other countries.
- IOS is a trademark or registered trademark of Cisco in the U.S. and other countries and is used under license.
- The company names and product names in this manual are the trademarks or registered trademarks of their respective companies.

Table of Contents

Special Features	8
Compatible Format and Functions.....	10
Included Accessories.....	10
About the Manuals.....	11

Setting Up

Panel Controls and Terminals	12
Setting Up	14
Power Requirements	14
Turning the Power On/Off.....	16
Adjusting the Master Volume.....	16
Using a Keyboard Stand.....	16

Quick Guide

Basic Operation and Display Items	17
Basic Operation	17
Display Items	18
Try Playing a Variety of Instrument Voices	19
Selecting a Main Voice	19
Resetting the Voice settings to Default (Playing the Harmonium Voice)	19
Playing the Grand Piano Voice.....	19
Layering a Dual Voice.....	19
Playing a Split Voice in the Left Hand area	20
Using the Metronome	20
Adding Harmony/Triggering Arpeggios.....	21
Changing the Harmony and Arpeggio types.....	22
Adding DSP Effects	23
Creating Original Sounds via the Knobs	24
Assigning Functions to the Knobs	24
Switching the Target	24
Using the Knobs	24
Playing Styles	25

Playing Songs

Listening to a Demo Song	27
Selecting and Playing Back a Song	27
Song Fast Forward, Fast Reverse, and Pause.....	27
Playing a Specified Section of a Song Repeatedly (A-B Repeat).....	28
Turning Each Track On/Off.....	28

Using the Song Lesson Feature

Three Types of Song Lesson	29
Practicing with Song Lesson.....	29
Making Practice Perfect—Repeat & Learn	30

Playing the Riyaz

Playing with Quick Sampling

Playing back the Samples	32
Getting Ready for Sampling.....	32
Sampling External Audio Sound	33
Restoring the Default Samples	35
Saving a Sample to a USB Flash Drive	35
Loading a Sample from a USB Flash Drive	36
Deleting a Sample in the USB Flash Drive	36

Recording Your Performance

Track Structure of a Song	37
Quick Recording	37
Recording to a Specified Track.....	38
Clearing a User Song	39
Clearing a Specified Track from a User Song	39

Audio Playback and Recording

Playing back an Audio File in a USB Flash Drive	40
Recording/Saving Audio Files to a USB Flash Drive	41
Deleting Audio Files from the USB Flash Drive	42

Memorizing Your Favorite Settings (Registration Memory)

Memorizing Panel Settings to the Registration Memory	43
Recalling Panel Settings from the Registration Memory	43
Freezing the Style settings even if a different Registration number is selected	44
Freezing the Transpose settings even if a different Registration number is selected	44

Special Features



Play the keyboard with any one of the amazingly rich and wide-ranging 801 voices. (▶ Page 19)



Take your performance to new levels—whatever music you play—with 282 auto accompaniment Styles. (▶ Page 25)



The 10 DSP (Digital Signal Processor) effects provide powerful ways to enhance and totally change the sound. (▶ Page 23)



The two Live Control Knobs let you add dynamic sound variations—including classic filter effects, distortion and reverb—giving you the tools to completely transform the sound. (▶ Page 24)

Riyaz

▶ Page 31



Loaded with a wide variety of Indian phrases using real Tabla and Tanpura sounds. Also includes extensive lesson functions using the RAGA SCALE Songs. You can expand the expressive range by using various functions, including Live Controls and Portamento, a continuous pitch change that is essential to Indian music.

Connecting to Other Devices	45
Connecting Headphones or an External Device.....	45
Connecting a Footswitch to the SUSTAIN jack	45
Playing an External Audio Device with the Built-in Speakers ...	46
Using the Melody Suppressor.....	46
Using with Computer or Smart Device.....	47
Backup and Initialization	48
Backup Parameters	48
Initializing the Instrument.....	48
Reference	
Handy Performance Features	49
Selecting a Reverb Type	49
Selecting a Chorus Type	49
Pitch Controls—Transpose.....	50
Pitch Controls—Fine Tuning.....	50
Pitch Controls—the [PITCH BEND] wheel.....	50
Using Portamento	50
Setting the Portamento time	51
Calling Up Optimum Panel Settings—One Touch Setting (OTS) ...	51
Changing the Touch Response of the Keyboard.....	51
Selecting an EQ Setting for the Best Sound.....	52
Scale Tuning	53
Selecting a Scale	53
Setting the Base Note for Each Scale	53
Tuning Each Note to Create an Original Scale.....	54
Voice Settings	55
Selecting a Dual Voice.....	55
Selecting a Split Voice.....	55
Voice Editing.....	55
Arpeggio Settings	56
Synchronizing an Arpeggio to Song/Style/Riyaz Playback—Arpeggio Quantize	56
Holding the Arpeggio Playback via the Footswitch.....	56
Parameters Assigned to the Knobs	57

Styles and Riyaz Patterns	59
Style Variations—Sections	59
Style Synchro Stop	60
Turning Each Style Track On/Off.....	60
Riyaz Variations.....	61
Changing the Tempo	61
Tap Start.....	61
Adjusting the Volume of the Style or Riyaz.....	62
Setting the Split Point	62
Playing Chords Without Style Playback (Stop Accompaniment) ..	62
Chord Types for Style Playback	63
Song Settings	64
Background Music Playback.....	64
Random Song Playback	64
Tempo Setting of the Song	65
Tap Start.....	65
Song Volume.....	65
Melody Voice Setting of the Preset Song	65
The Functions	66
Basic Procedure in the Function Display	66
USB Flash Drive Operations	71
Connecting a USB Flash Drive	72
Formatting a USB Flash Drive	73
Saving User Data to a USB Flash Drive	73
Saving a User Song as SMF to a USB Flash Drive	74
Loading User Data from a USB Flash Drive	75
Loading a Style File	76
Deleting a User File in the USB Flash Drive.....	77
Deleting an SMF File in the USB Flash Drive.....	77
Exiting from a File Control Display.....	78
Message List.....	78
Appendix	
Troubleshooting.....	79
Specifications	80
Index.....	82

Quick Sampling ▶ Page 32

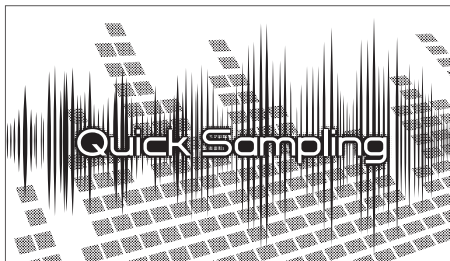

The Quick Sampling feature lets you sample short sounds from an external device, and play them from the keyboard—as rhythm loops, melodies or sound effects—giving you even greater creative expressive tools for your performance.

USB Audio Recording ▶ Page 40

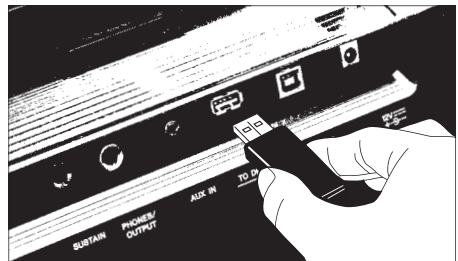

This convenient feature lets you record your performances to a USB flash drive. Since the recorded data is saved as an audio file, you can easily play it back on a computer or portable audio player.

Compatible Format and Functions



GM System Level 1

“GM System Level 1” is an addition to the MIDI standard which ensures that any GM-compatible music data can be accurately played by any GM-compatible tone generator, regardless of manufacturer. The GM mark is affixed to all software and hardware products that support GM System Level.



XGlite

As its name implies, “XGlite” is a simplified version of Yamaha’s high-quality XG tone generation format. Naturally, you can play back any XG song data using an XGlite tone generator. However, keep in mind that some songs may play back differently compared to the original data, due to the reduced set of control parameters and effects.



USB

USB is an abbreviation for Universal Serial Bus. It is a serial interface for connecting a computer with peripheral Devices. It allows “hot swapping” (connecting peripheral devices while the power to the computer is on).



STYLE FILE FORMAT (SFF)

The Style File Format is Yamaha’s original style file format which uses a unique conversion system to provide high-quality automatic accompaniment based on a wide range of chord types.

Included Accessories

- Owner’s Manual (this book)
- AC adaptor*
- Music rest
- Online Member Product Registration

* May not be included depending on your area. Check with your Yamaha dealer.

Attaching the Music Rest

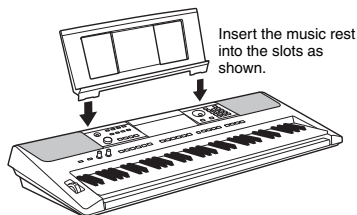

About the Manuals

This instrument has the following documents and instructional materials.

■ Included Documents



Owner's Manual (this book)

- Setting Up Please read this section first.
- Quick Guide This section explains how to use the basic functions.
- Reference This section explains how to make detailed settings for the various functions of the instrument.
- Appendix This section includes troubleshooting and specifications.

■ Online Materials (PDF)



Data List

Contains various important preset content lists such as those of Voices, Styles, Riyaz patterns and Effects.



MIDI Reference

Contains MIDI-related information for this instrument.



MIDI Basics (only in English, French, German and Spanish)

Contains basic explanations about MIDI.



Computer-related Operations

Includes instructions on connecting this instrument to a computer, and operations related to transmitting/receiving the data.



iPhone/iPad Connection Manual

Explains how to connect the instrument to smart devices, such iPhone, iPad, etc.

To see the above materials, access the Yamaha website. Open the following website, enter the model name and search them.

Yamaha Downloads <https://download.yamaha.com/>

■ Song Book/Song Data

To obtain these materials, access the Yamaha website at "Download" tab below the model name.



Song Book (only in English, French, German, Spanish and Japanese)

Contains music scores for the preset Songs (excluding the Demo Songs) of this instrument and the optional Songs.



Song Data

Contains the data of 70 Songs that can be played back with this instrument.

NOTE

- The downloaded Song data can be played back by transferring data from the computer to the instrument or saving data to the USB flash drive (page 26).

Panel Controls and Terminals

Front Panel

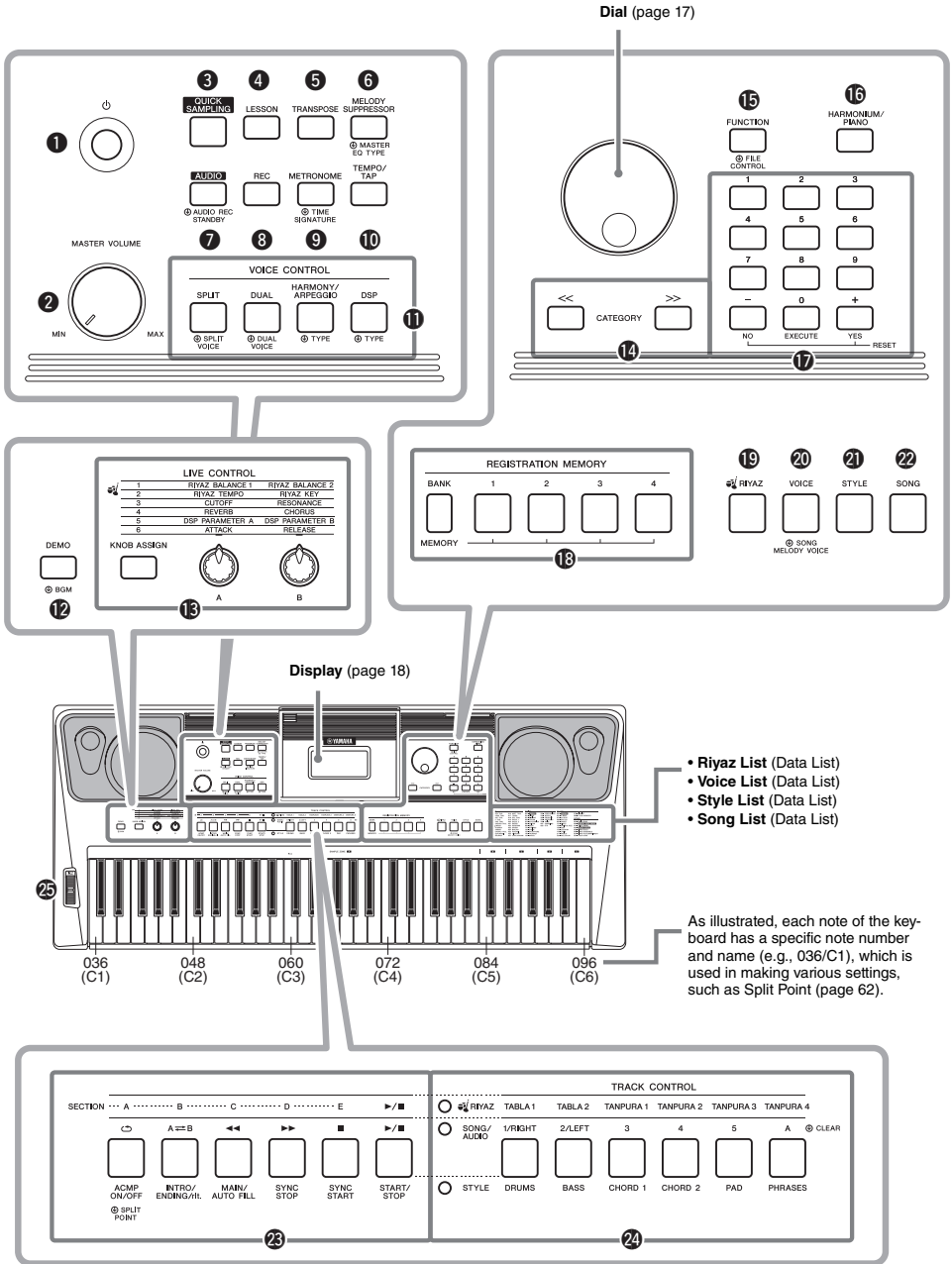

- Riyaz List (Data List)
- Voice List (Data List)
- Style List (Data List)
- Song List (Data List)

As illustrated, each note of the keyboard has a specific note number and name (e.g., 036/C1), which is used in making various settings, such as Split Point (page 62).

- ❶ [⏻] (Standby/On) switch page 16
- ❷ [MASTER VOLUME] control page 16
- ❸ [QUICK SAMPLING] button page 32
- ❹ [LESSON] button page 29
- ❺ [TRANPOSE] button page 50
- ❻ [MELODY SUPPRESSOR] button page 46
- ❼ [AUDIO] button page 40
- ❽ [REC] button page 37
- ❾ [METRONOME] button page 20
- ❿ [TEMPO/TAP] button page 61
- ⓫ VOICE CONTROL section
 - [SPLIT] button page 20
 - [DUAL] button page 19
 - [HARMONY/ARPEGGIO] button page 21
 - [DSP] button page 23
- ❿ [DEMO] button page 27
- ⓬ LIVE CONTROL section
 - [KNOB ASSIGN] button page 24
 - [A] and [B] knobs page 24
- ⓭ CATEGORY buttons page 17
- ⓮ [FUNCTION] button page 66
- ⓯ [HARMONIUM/PIANO] button page 19
- ⓰ Number buttons [1]–[9], [–/NO], [0/EXECUTE] and [+ /YES] buttons page 17
- ⓱ REGISTRATION MEMORY buttons
 - [BANK/MEMORY] buttons page 43
 - [1]–[4] buttons page 43
- ⓲ [RIYAZ] button page 31
- ⓳ [VOICE] button page 19
- ⓴ [STYLE] button page 25
- ⓵ [SONG] button page 27
- ⓶ RIYAZ/SONG/STYLE Control buttons
 - When the [RIYAZ] lamp is on: pages 31 and 61
 - When the [SONG/AUDIO] lamp is on: page 27
 - When the [STYLE] lamp is on: pages 25, 59, and 60
- ⓷ TRACK CONTROL buttons
 - When the [RIYAZ] lamp is on: page 31
 - When the [SONG/AUDIO] lamp is on: pages 28, 37
 - When the [STYLE] lamp is on: page 60
- ⓸ [PITCH BEND] wheel page 50

Rear Panel

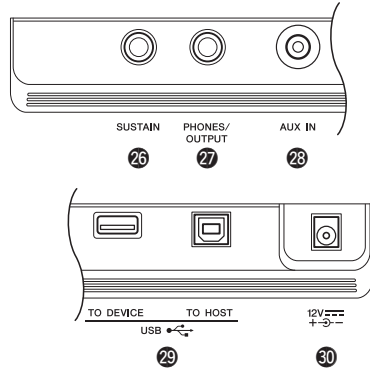

- ❷❶ [SUSTAIN] jack page 45
- ❷❷ [PHONES/OUTPUT] jack page 45
- ❷❸ [AUX IN] jack page 46
- ❷❹ [USB TO DEVICE] terminal page 71
- ❷❺ [USB TO HOST] terminal page 47
- ❷❻ DC IN jack page 14

Panel Setup (Panel Settings)

By using the controls on the panel, you can make various settings as described here. These settings of the instrument are together referred to as "panel setup" or "panel settings" in this manual.

Power Requirements

Although the instrument will run either from an AC adaptor or batteries, Yamaha recommends use of an AC adaptor whenever possible. An AC adaptor is more environmentally friendly than batteries and does not deplete resources.

NOTICE

- You should use an AC adaptor when executing USB flash drive operations, since battery power may not be reliable enough to last through these crucial operations.

Using an AC Adaptor

Connect the AC adaptor in the order shown in the illustration.

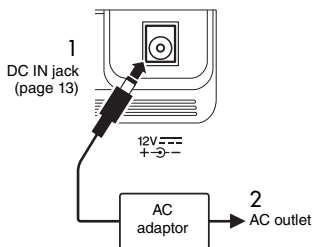

WARNING

- Use the specified AC adaptor (page 81) only. Using the wrong AC adaptor can result in damage to the instrument or overheating.

WARNING

- When using the AC adaptor with a removable plug, make sure to keep the plug attached to the AC adaptor. Using the plug alone can cause electric shock or fire.
- Never touch the metallic section when attaching the plug. To avoid electric shock, short circuit or damage, also be careful that there is no dust between the AC adaptor and plug.

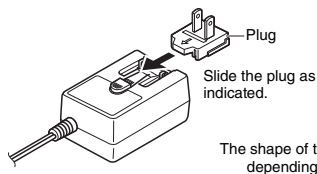

CAUTION

- When setting up the product, make sure that the AC outlet you are using is easily accessible. If some trouble or malfunction occurs, immediately turn the power off and disconnect the plug from the outlet.

NOTE

- Follow this procedure in reverse order when disconnecting the AC adaptor.

Using Batteries

This instrument requires the following batteries.

Six "AA" size alkaline (LR6), manganese (R6) or Ni-MH rechargeable batteries.

The Alkaline batteries or rechargeable Ni-MH batteries are recommended for this instrument, since other types may result in poorer battery performance.

NOTICE

- When using Ni-MH batteries, follow the instructions that came with the batteries.

- 1 Make sure that the power of the instrument is off.
- 2 Open the battery compartment cover located on the instrument's bottom panel.

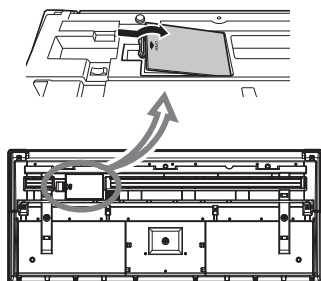

- 3 Insert the six new batteries, putting them in the correct direction according to the illustration.

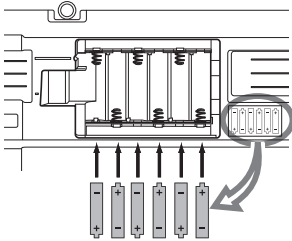

- 4 Replace the compartment cover, making sure that it locks firmly in place.

NOTICE

- **Connecting or disconnecting the AC adaptor with batteries installed may turn the power off, resulting in loss of data being recorded or transferred at the time.**
- **Make sure to set the battery type correctly (page 15).**
- **When battery power becomes too low for proper operation, the volume may be reduced, the sound may be distorted, and other problems may occur. When this happens, make sure to replace all batteries with new ones or already-recharged ones.**

NOTE

- This instrument cannot charge the batteries. Use only the specified charger device when charging.
- Power will be automatically drawn from the AC adaptor if an AC adaptor is connected while batteries are installed in the instrument.

■ Setting the battery type

Depending on the battery type to be used, you may need to change the battery type setting on this instrument. To change the setting, first turn on the power to the instrument, then choose the battery type you would like to use. Alkaline (and manganese) batteries are chosen by default. For details, refer to page 69, Function 072.

NOTICE



- **Failure to set the battery type may shorten the amount of the battery life. Make sure to set the battery type correctly.**

■ Checking the power status

You can confirm the power source at the left corner of the display.

Only one of these is shown.





-  : The power is supplied from the AC adaptor.
-  : The power is supplied from the batteries.

NOTE

- When the AC adaptor is plugged in to the AC outlet, the battery icon does not appear even when batteries are inserted. In this case, the power is supplied from the AC adaptor.

Remaining battery power indication

	Indicates that the power will be turned off immediately.
	Indicates that remaining power is insufficient for operation. Before the power runs out, replace all the batteries with new ones, or fully recharged ones (when using rechargeable types). Note that the instrument may not work properly, including unusually soft volume and poor sound quality when remaining power becomes low.
	Indicates that the remaining power is sufficient.

Turning the Power On/Off

- 1 Turn down the [MASTER VOLUME] control to "MIN".

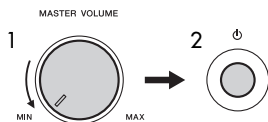

- 2 Press the [⏻] (Standby/On) switch to turn the power on.
- 3 Press and hold the [⏻] (Standby/On) switch for about a second to turn the power off.

⚠ CAUTION

- Even when the power is off, a small amount of electricity is still being consumed by the instrument. When you are not using the instrument for a long time, make sure to unplug the AC adaptor from the wall AC outlet.

NOTICE

- Press only the [⏻] (Standby/On) switch when turning the power on. Any other operations such as pressing keys, buttons or the pedal are not allowed. Doing so may cause the instrument to malfunction.

Setting the Auto Power Off function

To prevent unnecessary power consumption, this instrument features an Auto Power Off function that automatically turns the power off if the instrument is not operated for a specified period of time. The amount of time that elapses before the power is automatically turned off is 30 minutes by default; however, you can change the setting. For details, refer to page 69, Function 071.

■ Disabling Auto Power Off (simple method)

Turn the power on while holding down the lowest key on the keyboard. This starts the instrument with the Auto Power Off function disabled.

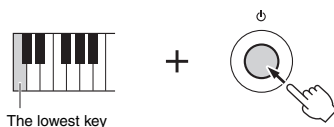

The lowest key

NOTICE

- When the instrument is not operated for a specified period of time while connected to an external device such as an amplifier, speaker or computer, make sure to follow the instructions in the Owner's Manual to turn off the power to the instrument and the connected devices, in order to protect the devices from damage. If you do not want the power to turn off automatically when a device is connected, disable Auto Power Off.

NOTE

- Generally, the data and settings are maintained even when the power is turned off. For details, see page 48.

Adjusting the Master Volume

To adjust the volume of the entire keyboard sound, use the [MASTER VOLUME] control while playing the keyboard.

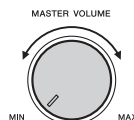

⚠ CAUTION

- Do not use the instrument for a long period of time at a high or uncomfortable volume level, since this can cause permanent hearing loss.

Using a Keyboard Stand

The following keyboard stands (sold separately) can be used.

- L-2C

⚠ CAUTION

- Do not place the instrument in an unstable position where it might accidentally slip down. This could cause physical injury to you or others, as well as damage to the instrument or other property.

Basic Operation and Display Items

Basic Operation

This instrument features four basic functions: Voice, Style, Song and Riyaz. To use this instrument, select a basic function first, and then make various settings.

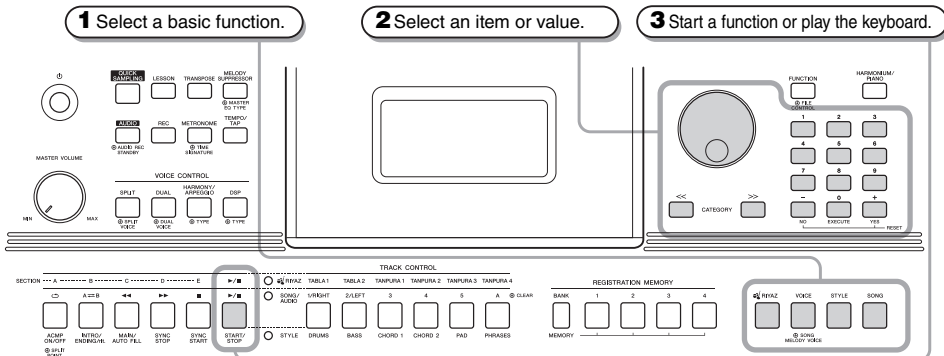

Quick Guide

Dial

Rotate the dial clockwise to increase the value of the selected item, or counter-clockwise to decrease its value.

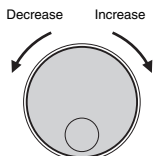

* In most procedures described throughout this manual, the dial is used for selecting items or changing values. Note however, that in most cases in which the dial can be used to change values, the [+]/YES and [-]/NO buttons can also be used.

CATEGORY [<<], [>>] buttons

When selecting a Voice, Style, Riyaz, Song, etc., you can use these buttons to jump to the first item in the next or previous category. These buttons can also be used to select function items sequentially after pressing the [FUNCTION] button.

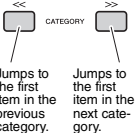

Number buttons [0]–[9]

Use these buttons to directly enter the desired Style/Voice number etc, or a parameter value.

Example:
Selecting Voice 003, Harmnum3.

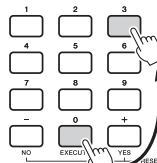

Press number buttons [0], [0], [3].

[+]/YES, [-]/NO buttons

Press the [+]/YES button briefly to increase the value by 1, or press the [-]/NO button briefly to decrease the value by 1. Press and hold either button to continuously increase or decrease the value in the corresponding direction.

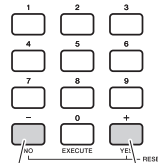

Press briefly to decrease. Press briefly to increase.

Pressing both buttons simultaneously lets you reset a parameter to the default value.

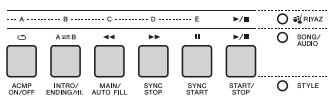

Depending on the basic function selected in step 1, you can use the different functions as printed on the panel. Song functions are printed above the buttons, Riyaz functions are printed further above, and Style functions are printed below.



The "Press & Hold" Symbol

Buttons having this indication can be used to call up an alternate function when the relevant button is pressed and held. Hold down this button until the function calls up.

Display Items

The display shows all the current settings of the Song, Style, Riyaz, Voice and other related functions.

Power source status

Indicates the source from which this instrument obtains power: AC adaptor or batteries (page 15).



USB connection status

Appears when a USB flash drive is connected to this instrument (page 71).

USB

Notation

Normally this indicates the notes you play.

NOTE

- Any notes occurring below or above the staff are indicated by "8va."
- For a few specific chords, not all notes may be shown, due to space limitations in the display.



Mode

AUDIO

Indicates that Audio Mode is enabled, allowing you to play back or record audio files from/to a USB flash drive (pages 40, 41).

SAMPLING

Indicates that the Quick Sampling mode is enabled, allowing you to sample sounds from an external audio device (page 32).

Sample Zone status

Indicates the assign status of the Sample feature. When a Sample type is set to Loop, (↻) is displayed.



On/off status

This area indicates the on/off status of each function. Each indication is shown when the corresponding function is turned on.

- SPLIT** page 20
- DUAL** page 20
- HARMONY** page 21
- ARPEGGIO** page 21
- TOUCH** page 51
- DSP** page 23
- SCALE** page 53
- MELODY SUPPRESSOR** page 46
- ACMP ON** page 25
- SYNC STOP** page 60

Beat

Indicates the current beat of playback (page 27).



Knob assignment

Indicates the parameters and target currently assigned to the knobs (page 24).



FUNCTION and MEASURE

Indicates the Function number when the [FUNCTION] button is pressed, or the current Measure number during playback of a Song, Style or Riyaz.



Chord

Indicates the chord which is being played in the Auto Accompaniment range (page 25) or specified via Song playback.



Track status

Indicates the on/off status of the current Song, Style or Riyaz (pages 28, 37, 60).

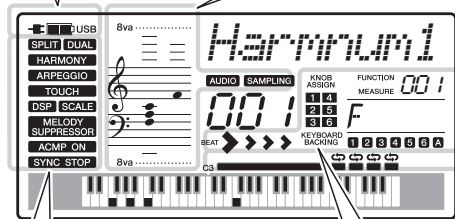

Try Playing a Variety of Instrument Voices

In addition to piano, organ, and other “standard” keyboard instruments, this instrument has a large range of Voices that includes traditional oriental instruments, as well as guitar, bass, strings, sax, trumpet, drums and percussion, and even sound effects—giving you a wide variety of musical sounds.

Selecting a Main Voice

1 Press the [VOICE] button.

The Voice number and name will be shown. For a list of available Voices, refer to the Voice List in the separate Data List.

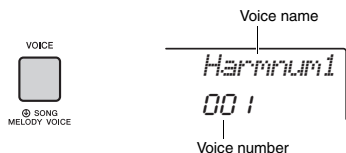

2 Use the dial to select the desired Voice.



3 Play the keyboard.



Preset Voice Types

001–267	Instrument Voices.
268–289 (Drum/SFX Kit)	Various drum/percussion or SFX sounds are assigned to individual keys. Details on assigning instruments to keys are provided in the Drum/SFX Kit List of the separate Data List.
290–339	Used for Arpeggio performance (page 21).
340–801	XGlite Voices.
802	Sample Voice.
000	Selecting this automatically calls up the most suitable Voice and panel setups for the current Style, Song or Riyaz. This function is called OTS (page 51).

Resetting the Voice settings to Default (Playing the Harmonium Voice)

To reset various settings to their default values, press the [HARMONIUM/PIANO] button.

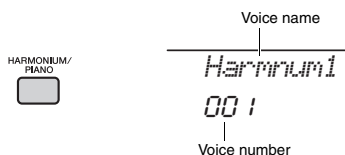

Voice 001 “Harmnum1” will automatically be selected as the Main Voice.

NOTE

- If Voice 001 “Harmnum1” has already been selected, pressing the button selects Voice 041 “Grand Piano.” In this case, press the button once more.

Playing the Grand Piano Voice

To quickly and easily call up a piano sound for simple piano playing, press the [HARMONIUM/PIANO] button, repeatedly if necessary, until Voice 041 “Grand Piano” is shown in the display.

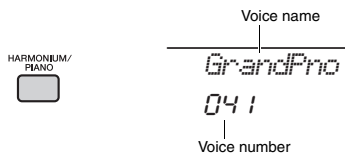

This selects Voice 041 “Grand Piano” as the Main Voice.

Layering a Dual Voice

In addition to the Main Voice, you can layer a second, different Voice over the entire keyboard as a “Dual Voice.”



1 Press the [DUAL] button to turn Dual on.

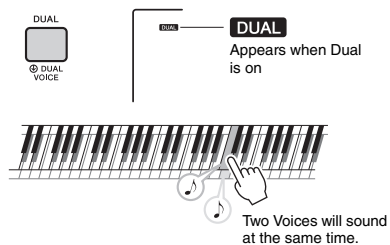

2 Press the [DUAL] button again to exit from Dual.

Although turning on Dual will select a Dual Voice suitable for the current Main Voice, you can also select a different Dual Voice (page 55).

Playing a Split Voice in the Left Hand area

By dividing the keyboard into the two separate areas, you can play a different Voice between the Left hand and Right hand areas.

1 Press the [SPLIT] button to turn Split on.



The keyboard is divided into left and right hand area at the Split Point. You can play a Split Voice on the left hand area while playing a Main Voice and Dual Voice on the right hand area of the keyboard.

Split Point ... default value: 054 (F#2)

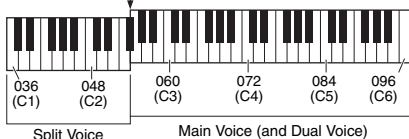

The Split Voice (page 55) and the Split Point can be changed as desired (page 62).

2 Press the [SPLIT] button again to exit from Split.

Using the Metronome

This instrument features a built-in metronome which can be used when practicing.

1 Press the [METRONOME] button to start the metronome.



2 Press the [METRONOME] button again to stop the metronome.

Adjusting the Metronome Tempo

This operation lets you adjust not only the metronome tempo, but also the tempo of Style, Song and Riyaz.

1 Press the [TEMPO/TAP] button to call up "Tempo."

The current tempo is shown on the display.

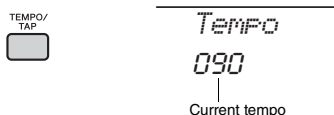

2 Adjust the tempo by rotating the dial.

Setting the Time Signature

This operation lets you change the time signature from the default value. In this example, we'll set a time signature of 6/8.

1 Hold down the [METRONOME] button for longer than a second to call up "Time-Sign" (Time Signature Numerator).

The number of beats per measure is shown on the display.

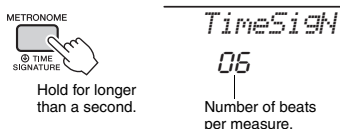

2 Rotate the dial to select the number of beats per measure.

A chime will sound on the first beat of each measure while a click sounds the other beats. If “0” is selected, a click sounds for all beats with no chime accent. Select 6 for this example.

NOTE 1

- This parameter cannot be set during playback of a Style, Song or Rhythm.

3 Press the CATEGORY [>>] button once to call up “TimeSigD” (Time Signature Denominator).

The length of one beat is shown on the display.

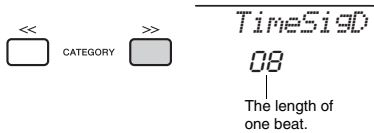

4 Rotate the dial to select the length of one beat, from 2nd, 4th, 8th and 16th note values.

Select “08” (8th note) for this example.

5 Confirm the setting by playing the Metronome.

Setting the Metronome Volume

1 Press the [FUNCTION] button.



2 Use the CATEGORY [<<] and [>>] buttons to call up “MtrVol” (Function 062).

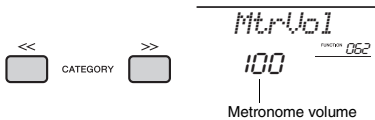

3 Rotate the dial to set the volume.

Adding Harmony/Triggering Arpeggios

You can add effects such as Harmony, Tremolo and Echo to the Main Voice. For a list of the effects, refer to the Harmony Type List in the online material Data List.

1 Press the [HARMONY/ARPEGGIO] button to turn Harmony or Arpeggios on.

The HARMONY or ARPEGGIO icon appears on the display and the Harmony effect or the Arpeggio function turns on.

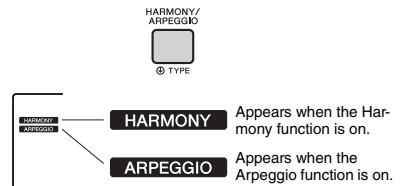

Although turning on the Harmony or the Arpeggio will select a Harmony type or an Arpeggio type suitable for the current Main Voice, you can select a different Harmony type or Arpeggio type (page 22).

2 Press a note or notes to add a Harmony or trigger an Arpeggio.

The operation differs depending on the Harmony type. Try playing the keyboard by referring to “Playing each Harmony Type” (see next page), and the Harmony Type List on the Data List (online).

The Arpeggio phrase differs depending on the number of pressed notes and the area of the keyboard.

3 Press the [HARMONY/ARPEGGIO] button again to turn the Harmony or Arpeggio off.

NOTE 1

- When Split (page 20) is on, Arpeggio is applied only to the Split Voice. When Split is off, Arpeggio is applied to the Main and Dual Voices. Arpeggio cannot be applied to the Split and Main/Dual Voices simultaneously.
- Selecting a Voice number between 330 and 339 will turn on Split automatically, as well as Arpeggio. When one of those Voices is selected, Arpeggio is applied only to the Split Voice and is triggered only by playing a key to the left of the Split Point.
- By assigning the Arpeggio Hold function to the foot-switch, the Arpeggio will continue to play after the note is released (page 56).

Playing each Harmony Type

■ Harmony types 01 to 05

In Riyaz mode

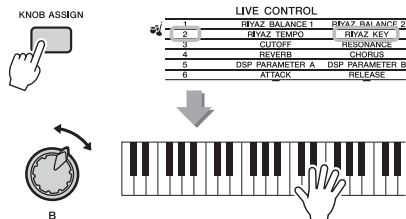

While the Riyaz mode (page 31) is on, press the [KNOB ASSIGN] button several times to select "2 RYIAZ KEY." Turn Knob B to change the key in semitone units while playing the melody on the keyboard. The selected KNOB ASSIGN and the specified key are shown in the display.

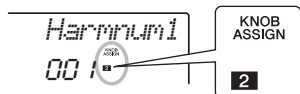

In Auto accompaniment mode



Press the right-hand keys while playing chords in the Auto Accompaniment area of the keyboard when ACMP is on (page 25).

■ Harmony types 06 to 12 (Trill)

Both in Riyaz and auto accompaniment modes



Hold down two keys.

■ Harmony types 13 to 19 (Tremolo)

Both in Riyaz and auto accompaniment modes



Keep holding down the keys.

■ Harmony types 20 to 26 (Echo)

Both in Riyaz and auto accompaniment modes



Play the keys.

Changing the Harmony and Arpeggio types

1 Hold down the [HARMONY/ARPEGGIO] button for longer than a second.

After "Harm/Arp" (Function 044) appears on the display, the current Harmony type or Arpeggio type appears.

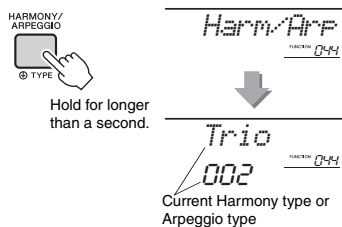

2 Rotate the dial to select the desired Harmony type or Arpeggio type.

NOTE

- 001 to 026 are Harmony types. 027 to 186 are Arpeggio types. Refer to the Harmony Type List / Arpeggio Type List on web material Data List.
- When playing one of the Arpeggio types 143 or later, select a Drum Kit (Voice No.268–289) as the Main Voice.

Adjusting the Harmony Volume

You can adjust the Harmony volume in the Function Settings (page 68, Function 045).

Adjusting the Arpeggio Velocity

You can adjust the Arpeggio velocity in the Function Setting (page 68, Function 046).

Adding DSP Effects

DSP is an abbreviation for Digital Signal Processor, and provides effects that enhance the sound. DSP effects are applied only to a specified target as described below.

Parts to which DSP effects are applied

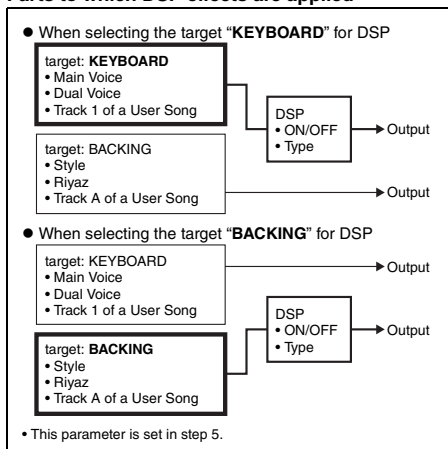

1 Press the [DSP] button to turn DSP on.



Although turning on DSP will select a DSP type suitable for the current panel setting, you can select a different DSP type as described in the following steps.

2 Hold down the [DSP] button for longer than a second to call up "DSP Type" (Function 042).

After a few seconds, the current DSP type appears.

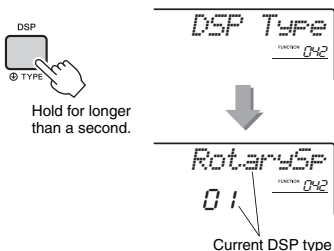

3 Rotate the dial to select a DSP type.

For information about the available DSP types, refer to the Effect Type List in the Data List.

4 Press [KNOB ASSING] button to select 5.

5 Press the [FUNCTION] button to select the target.



6 Use the CATEGORY [<<] and [>>] buttons to call up "Target" (Function 043).

After a few seconds, the current target (KEYBOARD or BACKING) appears.



7 Press the [+ / YES] or [- / NO] button to switch between KEYBOARD and BACKING.

When KEYBOARD is selected, the DSP affects the Main Voice, Dual Voice or track 1 of a User Song. When BACKING is selected, it affects the Style, Riyaz or track A of a User Song.

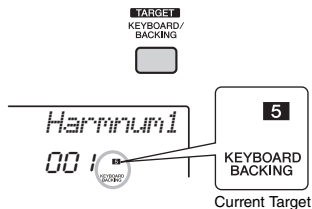

8 Press the [DSP] button again to turn DSP off.

Limitations when recording a Song

- DSP effects can be recorded only to Tracks 1 and A.
- The DSP type and target cannot be changed while recording.
- When recording to an existing User Song, if the target to which the DSP effects are applied differs from the recording tracks, DSP related setting data (DSP target, type, parameter A/B) will not be recorded or overwritten.
- The DSP effects may not be applied as expected when a User Song is being played back. This is because the DSP effects are affected by the data recorded to the User Song.

Creating Original Sounds via the Knobs

The two knobs can be used to add variations to the sound being played, transforming the sound in a variety of musical ways. Select the desired pre-programmed function combination printed above the knobs, then rotate the knobs as you play, for an expressive, dynamic performance.

Assigning Functions to the Knobs

Repeatedly press the [KNOB ASSIGN] button to sequentially assign the function combinations provided: **1** → **2** → **3** → **4** → **5** → **6** → **1** ... etc. The current combination is shown in the display.

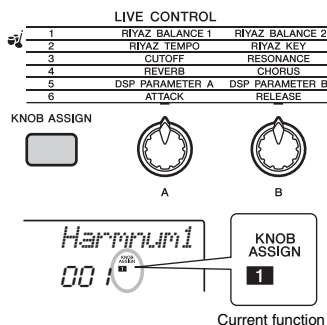

The target differs depending on the selected number. For details about each function, refer to page 57.

NOTE

- Only selecting a function combination will not affect the sound even if the knob arrow is not at the center position. The selected function only works when the knob is moved.
- Depending on the panel settings or how you move the knob, you may not notice any change to the parameter value, or you may hear a noise, or the knob may not work properly, even if you rotate it.

Switching the Target

Switches the target to be controlled. The current target is shown in the display.

1 Press the [FUNCTION] button.



2 Use the CATEGORY [<<] and [>>] buttons to call up “Target” (Function 043).

After a few seconds, the current target (KEYBOARD or BACKING) appears.



3 Press the [+ / YES] or [- / NO] button to switch between KEYBOARD and BACKING.

- **KEYBOARD:** Main Voice, Dual Voice and User Song (only Live Control function 5)
- **BACKING:** Style, Riyaz and User Song (only Live Control function 5)

NOTE

- The target differs depending on the selected function.
- The target is memorized for each function.

Using the Knobs

Here is an example of how to use the knobs. For some other ideas for using the knobs, refer to page 58.

1 Select the desired Main Voice (page 19).

Here, select Voice No.196 “SquareLd” (Square Lead) as a synth-lead type Voice.

2 Press the [KNOB ASSIGN] button several times until **3** appears in the display.

3 Press the [FUNCTION] button.

4 Rotate knob B all the way to the right (maximum), then play the keyboard with your right hand while operating knob A with your left.

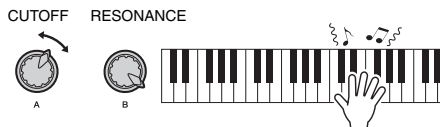

NOTICE

- After selecting **3**, **4**, **5** or **6** by pressing the [KNOB ASSIGN] button, changing the Voice will replace the settings created via the knobs with the default settings of the new Voice. If you want to keep the settings you have created, make sure to memorize them to Registration Memory (page 43) before selecting a different Voice.

NOTE

- Rotating a knob to the right while the volume is set to a high level may result in distortion. If this occurs, reduce the volume level.

Playing Styles

This instrument includes an Auto Accompaniment feature that plays appropriate “Styles” (rhythm + bass + chord accompaniment). You can select from a huge variety of Styles covering a wide range of musical genres.

1 Press the [STYLE] button, then use the dial to select the desired Style.

For the Style List, refer to the online material Data List.

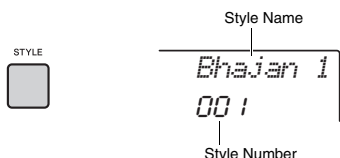

NOTE

- Press the CATEGORY [\ll]/[\gg] button to change the musical genre. Refer to the Style List at the top of the panel.

STYLE

001- INDIAN	270- PIANIST
051- B BEAT	283- FLASH MEMORY
074- R&B BEAT	
084- BALLAD	
097- DANCE	
131- DISCO	
139- SWING & JAZZ	
155- R&B	
170- COUNTRY	
178- LATIN	
211- WORLD	
236- BALLROOM	
247- TRADITIONAL	
256- WALTZ	
265- CHILDREN	

2 Press the [ACMP ON/OFF] button to turn on the Auto Accompaniment (ACMP).

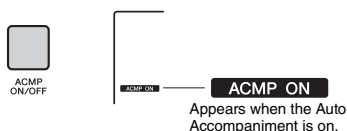

With this operation, the area of the keyboard to the left of the Split Point becomes the “Auto Accompaniment area” and is used only for specifying the chords. The rhythm part as well as the bass and chord accompaniment play back when you play chords.

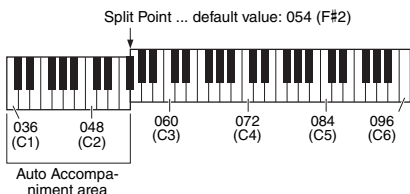

The Split Point can be changed as desired (page 62).

3 Press the [SYNC START] button to turn Synchro Start on.

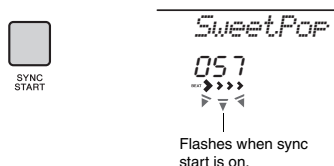

This puts the Style playback in “standby” and Style starts playing back when you play the keyboard.

4 Play a chord in the Auto Accompaniment area to start playback.

Play a melody with the right hand and chords with the left hand.

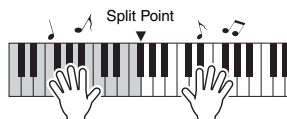

NOTE

- For information about how to play chords, refer to page 63.

5 Press the [START/STOP] button to stop playback.



You can easily add variations to your performance by changing the section of the Style. For details, refer to page 59.

Playing Songs

This instrument can play **Preset Songs, Songs you recorded on this instrument, or commercially available Songs.** In addition to listening to these Songs, you can play the keyboard along with the Song as it plays back.

MIDI Data

A MIDI Song is comprised of your keyboard performance information and is not a recording of the actual sound itself. The performance information refers to which keys are played, at what timing, and at what strength—just as in a musical score. Based on the recorded performance information, the tone generator (of the Clavinova, etc.) outputs the corresponding sound. A MIDI Song uses a small amount of data capacity in comparison to an Audio song, and allows you to easily change aspects of the sound, such as Voices used, etc.

NOTE

- For details on Audio playback and recording, refer to pages 40–41.

● Song Category

The Songs are organized by category as listed below.

SONG

- | | |
|---------------------------|--|
| 001 - MAIN DEMO | • Gives you an idea of the advanced capabilities of this instrument. |
| 004 - INDIAN VOICE DEMO | • Demonstrates the Indian Voices of this instrument using a typical musical phrase of India. |
| 014 - VOICE DEMO | • Demonstrates many useful Voices of this instrument. |
| 022 - RAGA SCALE | • Practice Songs for studying traditional Indian music scales. |
| 042 - PIANO SOLO | • Enjoyable piano solo performances. |
| 046 - PIANO ENSEMBLE | • These songs are piano ensemble pieces. Enjoy the sound of piano and orchestra. |
| 051 - PIANO ACCOMPANIMENT | • Enjoyable piano accompaniment in a variety of genres. |
| 061 - USER SONG | • Songs you've record yourself (page 37). |
| 071 - FLASH MEMORY / USB | • FLASH MEMORY: Songs transferred from a computer (page 47).
• USB: Songs in the USB flash drive (page 71). |

NOTE

- In addition to the 60 preset Songs in this instrument, you can enjoy extra Songs downloadable from the Yamaha website. For details, refer to page 11.
- For instructions on transferring Songs from a computer to this instrument, refer to the online PDF manual (page 11) "Computer-related Operations."
The numbers are generally assigned to the Songs in the following sequence: Songs transferred from a computer, Songs in the USB flash drive. When you transfer a Song from a computer while the USB flash drive is connected to the instrument, the transferred Song will be inserted before the first USB Song number, moving all USB Song numbers later in sequence.

Listening to a Demo Song

Press the [DEMO] button to play Demo Songs 001–003 in sequence. Playback will repeat continuously, starting again from the first Song (001).



To stop playback, press the [DEMO] or [▶/■] (Start/Stop) button.

Hold down the [DEMO] button for longer than a second to use the instrument as a background music source (page 64).

Selecting and Playing Back a Song

1 Press the [SONG] button, then rotate the dial to select the desired Song.

For a list of available Songs, refer to the Song List in the separate Data List.

You can select User Songs, Songs transferred from a computer, and Songs in the USB flash drive in the same way as above.

NOTE

- The selectable Songs are number 4 and later. When selecting the number 1 to 3, press [DEMO] button.

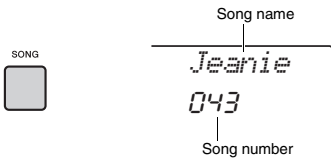

2 Press the [▶/■] (Start/Stop) button to start playback.

To stop playback, press the [▶/■] (Start/Stop) button again.

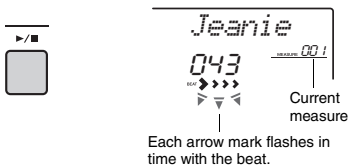

NOTE

- External MIDI Songs containing Portamento Control and Scale Tune settings may not be played correctly.
- If playback of a Song in the USB flash drive or a Song transferred from a computer produces distorted sound, decrease the Song volume (page 65) to reduce the distortion, and then adjust the master volume (page 16).

Song Fast Forward, Fast Reverse, and Pause

[▶▶] Fast Forward

During playback, press this button to rapidly skip ahead to a later point in the Song.



[◀◀] Fast Reverse

During playback, press this button to rapidly return to an earlier point in the Song.



[||] Pause

During playback, press this button to pause playback, and press again to start from that point.



NOTE

- When the A-B repeat is specified, the Fast Reverse and Fast Forward will only work within the range between A and B.
- The [◀◀], [▶▶] and [||] buttons cannot be used for Demo Song playback started by using the [DEMO] button.

Playing a Specified Section of a Song Repeatedly (A-B Repeat)

You can play back only a specific section of a Song repeatedly by setting the A point (start point) and B point (end point) in one-measure increments.



- 1 Start playback of the Song (page 27).
- 2 When playback reaches to the point you want to specify as the start point, press the [A ⇌ B] (A-B REPEAT) button to set the A point.



- 3 When playback reaches to the point you want to specify as the end point, press the [A ⇌ B] (A-B REPEAT) button again to set the B point.

The specified A-B section of the Song will now play repeatedly.

- 4 To cancel repeat playback, press the [A ⇌ B] (A-B REPEAT) button again.

To stop playback, press the [▶/■] (Start/Stop) button.

NOTE

- If you want to set start point "A" to the top of the Song, press the [A ⇌ B] (A-B REPEAT) button before starting playback.
- If you want to set end point "B" to the end of the Song, specify only the A point and play back the Song to the end.

Turning Each Track On/Off

Each "track" of a Song plays a different part—melody, percussion, accompaniment, etc. Each of the tracks can be muted so that you can play the muted part yourself. Pressing the desired Track button repeatedly will toggle the on/off status.

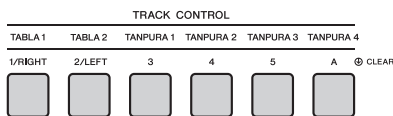

The status of each track is shown in the display.

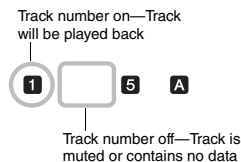

NOTE

- Up to two Track buttons can be pressed simultaneously for turning on or off.

Using the Song Lesson Feature

You can use the selected Song for a left-hand, right-hand, or both-hands lesson. Try practicing with these three Song Lesson types while referring to the music scores in the Song Book (page 11).

Three Types of Song Lesson

Lesson 1—Listen and Learn

In this Lesson, you need not play the keyboard. The model melody/chords of the part you selected will sound. Listen to it carefully and remember it well.



Lesson 2—Timing

In this mode, simply concentrate on playing the notes with the correct timing. Even if you play wrong notes, the correct notes shown in the display will sound.



Lesson 3—Waiting

In this Lesson, try playing the correct notes shown on the display. The Song pauses until you play the right note, and playback tempo will change to match the speed at which you are playing.



NOTE 1

- If you want to make sure a steady playback tempo is maintained during Lesson 3: Waiting, set the Your Tempo parameter (page 69) to OFF.
- When using Quick Sampling (page 32) or with a specific effect sound (Instrument number 802 [Smp1 Vce]), Sample Zones B to E do not play the assigned samples correctly while “Lesson 2:Timing” or “Lesson 3:Waiting” is being used.

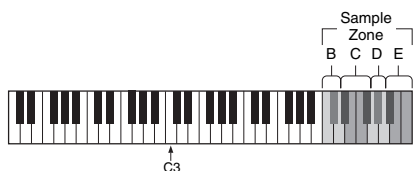

Sample Zone B: C5–D5
 Sample Zone C: D#5–F#5
 Sample Zone D: G5–A5
 Sample Zone E: A#5–C6

Practicing with Song Lesson

1 Select the desired Song for your lesson (page 26).

NOTE

- The Song Lesson can be applied also to the Songs (SMF format 0 only) transferred from a computer (page 26), but cannot be applied to the User Songs.

2 Turn off the part you want to practice.

For the right-hand lesson, press the [1/RIGHT] button to turn off the right-hand part. For the left-hand lesson, press the [2/LEFT] button to turn off the left-hand part. For a lesson using both hands, turn off both a parts.

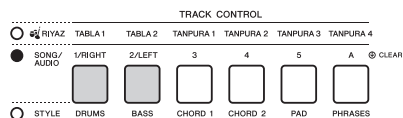

Pressing the [1/RIGHT] and [2/LEFT] buttons repeatedly will toggle the on/off status of each part, which can be shown on the display.

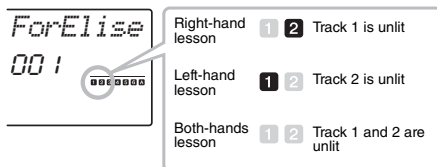

NOTE

- Song numbers 022–041 only support the right-hand lesson.

3 Press the [LESSON] button to start playback of the Song Lesson.

After starting playback, pressing the [LESSON] button repeatedly will change the Lesson number from 1: LISTEN → 2: TIMING → 3: WAITING → off → 1.... Press this button until the desired number is shown on the display.



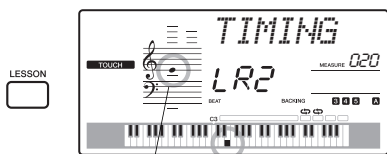

The notation and key positions you should play are shown.

To stop Lesson playback, press the [START/STOP] button.

Even during playback, you can change the Lesson number by pressing the [LESSON] button.

4 When Lesson playback reaches to the end, check your evaluation Grade on the display.

“2 Timing” and “3 Waiting” will evaluate your performance in four levels: OK, Good, Very Good, or Excellent.

See How You’ve Done

Excellent ■■■■■■■■
 Very Good ■■■■■■
 Good ■■■■
 OK ■■

When the lesson song has played all the way through your performance will be evaluated in 4 levels: OK, Good, Very Good, or Excellent. “Excellent” is the highest evaluation.

After the evaluation display is shown, the lesson will start again from the beginning.

Making Practice Perfect—Repeat & Learn

If you want to practice a specific section in which you made a mistake or you have difficulty with, use the Repeat & Learn function.

Press the [↶] (REPEAT & LEARN) button during Lesson playback.



The Song location will move back four measures, a one-measure count will play, and then Song playback will start again. Playback of the four measures will repeat with a one-measure count-in. To exit from this status, press this button again.

NOTE

- You can change the amount of measures the Repeat & Learn function jumps back by pressing a number button [1]–[9] during repeat playback.

Playing the Riyaz

This instrument provides 30 phrase patterns (consisting of several measures) using the authentic Tabla and Tanpura sounds with looped playback. By using the Riyaz function, try out the conventional Indian music—changing keys and creating dynamic sound variations by rotating the Knobs.

- Press the [RIYAZ] button, then use the dial to select the desired Riyaz pattern. Refer to the Riyaz list on the panel of this instrument.

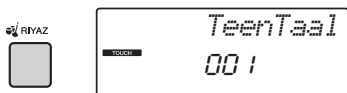

- Press the [START/STOP] button to start looped playback.

At first, only the Tabla sound will play back. During playback, enjoy creating sound variations via the following operations.



- Turning on/off Tabla tracks 1 and 2 individually

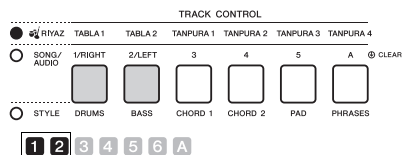

Indicates the on/off status of the Tabla tracks.

Tabla 1 features the lower pitched part while Tabla 2 features the higher pitched part.

- Adding the Tanpura phrase and changing it from 1–4

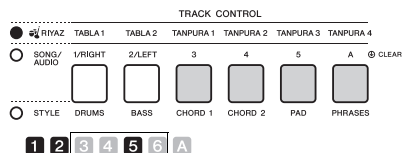

Indicates the current Tanpura number.

At first, press any of the [TANPURA 1]–[TANPURA 4] buttons to add a Tanpura phrase. Next, press another Tanpura button to change the phrase. You

can enjoy four phrase variations, which are shared among all Riyaz patterns. To turn off the Tanpura sound, press the Tanpura button of the current number.

- Changing the Variation via the [A]–[E] buttons

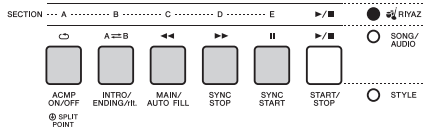

- Using the Knobs

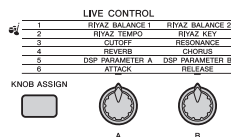

- Adjusting the Volume Balance

Press the [ASSIGN] button several times to select “1,” then rotate Knob A to adjust the volume balance between the sounds of Tabla 1 (low-pitched part) and Tabla 2 (high-pitched part), or rotate Knob B to adjust the volume balance between the sounds of the Tabla and Tanpura.

- Adjusting the Tempo / Transposing playback

Press the [ASSIGN] button several times to select “2,” then rotate Knob A to adjust the playback tempo, or rotate Knob B to transpose the playback key in semitones.

NOTE

- You can confirm the current key and tempo value on the display. To call up the current tempo value, press the TEMPO [-] or [+] button.

- Press the [START/STOP] button to stop playback.



NOTE

- You can record your performance and save it as an audio file to the USB flash drive. (page 41)

Playing with Quick Sampling

This instrument features an extremely convenient and powerful Quick Sampling function. It allows you to sample sounds from an external audio device (such as a computer, smartphone, portable music player, etc.) via the [AUX IN] jack, and then assign the sampled sound to the keyboard for playing back as part of your performance.

Sampling

Sampling is a technology that lets you record a short portion of a song or a sound, and use the sound (called a “sample”) as part of your performance. Unlike Audio Recording, the samples can be used in various ways: to play a melody, to play in a loop for a repeating rhythm pattern, or to add a special sound effect.

Playing back the Samples

A wide variety of samples are already built into this instrument as presets. Try playing them and see how powerful the sampling features are!

- 1 Press the [VOICE] button.
- 2 Use the dial to select the Voice number 802 “Sampling” for the Main Voice.

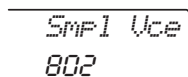

- 3 Press the keys in the Sample Zone to which the default samples are assigned to play back the samples.

Sample Zone

The keyboards of the two instruments are divided into five or seven Sample Zones and each Zone has one assigned sample.

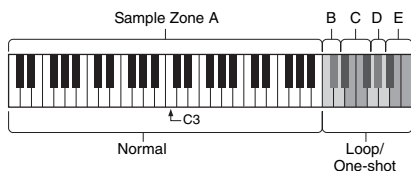

Sample Type

By default, a “Normal” type sample is assigned to Sample Zone A, “Loop” types are assigned to B and C, and “One-shot” types are assigned to D–E. However, when you sample by yourself, you can freely choose “Loop” or “One-shot” types for Sample Zones B–E.

- **Normal:** The pitch of the sound varies depending on the key you play. The default pitch is assigned to the note C3.
- **Loop:** The sample is played in a loop without changing the pitch. Pressing a white key in the Sample Zone plays the sample as long as you are holding it, while pressing a black key plays the sample continuously until you press a black key in the same Sample Zone to stop it. When the type is “Loop,”  appears on the display for the corresponding Sample Zone.
- **One-shot:** The sample is played only once without changing the pitch. The sample is played continuously as long as you hold any key in the Sample Zone.

Getting Ready for Sampling

- 1 Set the volume levels to minimum for both this instrument and the external device.

NOTICE

- Connecting an external device to the instrument without turning down the volume may result in damage to the device.

- 2 Connect the headphone jack of an external device to the instrument’s [AUX IN] jack by using an audio cable.

NOTICE

- To avoid damage to the devices, first turn on the power to the external device, and then to the instrument. When turning off the power, first turn off the power to the instrument, and then to the external device.

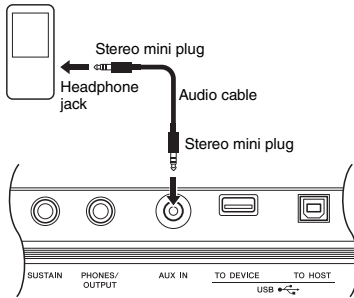

3 Start playback on the external device, and then adjust the volume balance between the device and the instrument.

- 3-1 Set the volume of the external device to maximum.
- 3-2 Adjust the volume you hear from the instrument by rotating the [MASTER VOLUME] control.

NOTE

• When the sound is too low even though the external device's volume is set to maximum, adjust the "AuxIn Vol" in the Function Settings (page 66, Function 004). If you increase the volume to more than 50, the audio device sound may be distorted. In this case, turn down the volume level on the external device.

Sampling External Audio Sound

Up to five samples can be assigned to the keyboard of this instrument. The samples can also be saved to a USB flash drive (page 35).

Before you start sampling, make sure that the external device's volume is set to maximum. If the volume is too low, the instrument cannot sample the sound.

NOTICE

- The sampling operation will overwrite and erase previously existing samples. Save important data you want to keep to a USB flash drive (page 35).

NOTE

- The sampling format is two-channel stereo, 16-bit with a rate of 44.1 kHz.
- If you want to use the metronome or Melody Suppressor when sampling, set these functions beforehand. The Metronome click is not sampled.

1 Press the [QUICK SAMPLING] button to enter the Quick Sampling mode.

The SAMPLING icon and "PressKey" appear on the display.

NOTE

- To cancel and exit from the Quick Sampling mode, press the [QUICK SAMPLING] button again.

2 Press a key in the desired Sample Zone to which the sample is to be assigned.

Pressing the key will sound the default sample or previously assigned sample.

• To sample a "Normal" type:

2-1 Press one of the keys in Sample Zone A.

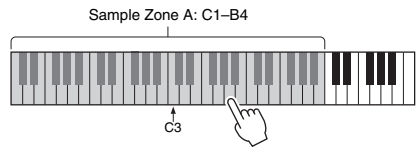

When "PressREC" appears on the display, go on to step 3.

• To sample a "Loop" or "One-shot" type:

2-1 Press one of the keys in the desired Sample Zone B to E.

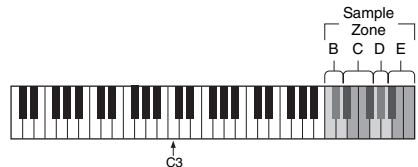

Sample Zone B: C5-D5
 Sample Zone C: D#5-F#5
 Sample Zone D: G5-A5
 Sample Zone E: A#5-C6

2-2 When "Loop?Y/N" appears on the display, press the [+ / YES] button to select "Loop" sampling, or press [- / NO] to select "One-shot" sampling. You cannot change the type after sampling.

When "PressREC" appears on the display, go on to step 3.

3 Pause playback on the external device at the beginning of the sound or phrase you want to sample.



4 Press the [REC] button, and then start playback on the external device to start sampling.

While sampling the sound, "REC" appears and glowing icon of selected the Sample Zone on the display.



Do not disconnect the USB flash drive during the sampling operation. The operation may become unstable, and sampling may not be performed properly.

5 Stop playback on the external device at the end of the sound or phrase you want to sample.

6 Press the [REC] button to stop sampling. "Writing!" appears briefly on the display, and then the sample is stored to the instrument.

NOTE

- If the input volume from the external device is too low, "LowInput" appears on the display and cannot sample the sound. Raise the external device's volume to maximum, and then adjust the output volume on this instrument by rotating the [MASTER VOLUME] control. After that, try sampling again from step 3.
- Sampling time is limited to a maximum of 9.6 seconds. When the time limit is reached, sampling stops automatically and the recorded sample (up to that point) is stored to the instrument.

7 Check if the sample is assigned successfully.

For "Normal" types, press the C3 key. For "Loop" and "One-shot" types, press any one key in the Sample Zone to which you assigned the sample. Any silence at the beginning and end of the sample can be automatically cut by the Blank Cut function (page 69).

If you are not satisfied with the sample, return to step 2 and try sampling again. To sample and assign to another Sample Zone, go on to step 2 again.

8 Press the [QUICK SAMPLING] button to exit from the Quick Sampling mode.

9 Try playing the samples.

Exiting from the Quick Sampling mode automatically selects the Voice number 802 "Smpl Vce" for the Main Voice. Try playing it on the keyboard.

NOTICE

To avoid damage to the external device, disconnect the device in this way:

- 1 Set the volume levels to minimum for both this instrument and the external device.
- 2 Disconnect the audio cable from the instrument, and then from the external device.

To sample during audio playback

Once you are familiar with the sampling operation, try starting and stopping sampling while the sound of the external device is playing back.

1. Execute steps 1–2 in "Sampling the External Audio Sound" on page 33.
2. Pause playback on the external device at a few measures before the sound or phrase you want to sample.
3. Start playback on the external device.
4. Press the [REC] button at the desired point to start sampling.
5. Press the [REC] button again at the desired point to stop sampling.
6. Stop playback on the external device, and then check what you have just sampled.

NOTE

- If there is silence in the audio that is cut automatically but you want to keep it, turn off the Blank Cut function (page 69).

Restoring the Default Samples

This operation lets you restore the default samples. However, keep in mind that this deletes the samples you've assigned to each Sample Zone. If you want to save your samples before restoring the default ones, see the next section ("Saving Samples to a USB Flash Drive").

- 1 Press the [QUICK SAMPLING] button to enter the Quick Sampling mode.
- 2 Press the appropriate key in the Sample Zone to which the sample to be cleared has been assigned.
- 3 Hold down the TRACK CONTROL [A] button for longer than a second.

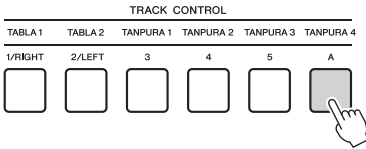

A confirmation message will appear on the display.

C1r-SMPL?

- 4 Press the [+ / YES] button.
A confirmation message will appear on the display. To cancel this operation, press the [-] button.
- 5 Press the [+ / YES] button to clear the Sample.
An in-progress message will appear briefly on the display.

Saving a Sample to a USB Flash Drive

IMPORTANT

• If the instrument is in the Quick Sampling mode, press the [QUICK SAMPLING] button to exit from the mode, and then follow the steps below.

- 1 Confirm the Sample Zone containing the sample you intend to save.
 - 1-1 Press the [VOICE] button.

- 1-2 Select the Voice number 802 "Sampling" for the Main Voice.
- 1-3 Press the key to confirm that the desired sample sounds.

2 Connect a USB flash drive to the [USB TO DEVICE] terminal.

For details, refer to "Connecting a USB Flash Drive" on page 72.

- 3 Hold the [FUNCTION] button for longer than a second to call up the File Control display. To cancel the operation, press the [FUNCTION] button again to exit from the File Control display.

4 Use the CATEGORY [<<] and [>>] buttons to call up "SaveSMPL."

SaveSMPL

5 Press the [0 / EXECUTE] button.

"PressKey" appears on the display.

6 Press the appropriate key in the Sample Zone (the key to which the desired sample is assigned).

7 Use the [+ / YES] and [- / NO] buttons to select the file name for saving.

- Normal/One-shot: SMPL001–SMPL250
- Loop: SMPLL001–SMPLL250

8 Press the [0 / EXECUTE] button.

"SaveOK?" appears on the display.

NOTE

- If the file name already exists in the USB flash drive, "Overwr?" appears on the display. To overwrite, press the [+ / YES] button; to select another name, press the [- / NO] button.

9 Press the [0 / EXECUTE] or [+ / YES] button again.

"Saving" appears on the display and the sample will be saved to the USB flash drive.

10 Press the [FUNCTION] button to exit from the File Control display.

Loading a Sample from a USB Flash Drive

IMPORTANT

- If the instrument is in the Quick Sampling mode, press the [QUICK SAMPLING] button to exit from the mode, and then follow the steps below.

NOTICE

- The loading operation will overwrite and erase previously existing samples. Save important data you want to keep to a USB flash drive (page 35).

1 Connect a USB flash drive to the [USB TO DEVICE] terminal.

For details, refer to “Connecting a USB Flash Drive” on page 72.

2 Hold the [FUNCTION] button for longer than a second to call up the File Control display.

To cancel the operation, press the [FUNCTION] button again to exit from the File Control display.

3 Use the CATEGORY [<<] and [>>] buttons to call up “LoadSMPL.”

LoadSMPL

4 Press the [0/EXECUTE] button.

“PressKey” appears on the display.

5 Press the appropriate key in the Sample Zone to which you want to assign the sample.

6 Use the [+ /YES] and [- /NO] buttons to select the file name to load.

You cannot select a sample that loops (SMPLL001–SMPLL250) for assigning to Sample Zone A.

7 Press the [0/EXECUTE] button.

“LoadOK?” appears on the display.

8 Press the [0/EXECUTE] or [+ /YES] button again.

“Loading” appears on the display and the sample will be loaded from the USB flash drive.

9 Press the [FUNCTION] button to exit from the File Control display.

10 Try playing with the loaded samples.

Press the [VOICE] button and select the Voice number 802 “Smpl Vce” for the Main Voice. Pressing the appropriate key in the Sample Zone (to which you assigned the sample) to play the sound.

Deleting a Sample in the USB Flash Drive

IMPORTANT

- If the instrument is in the Quick Sampling mode, press the [QUICK SAMPLING] button to exit from the mode, and then follow the steps below.

1 Connect a USB flash drive to the [USB TO DEVICE] terminal.

For details, refer to “Connecting a USB Flash Drive” on page 72.

2 Hold the [FUNCTION] button for longer than a second to call up the File Control display.

To cancel the operation, press the [FUNCTION] button again to exit from the File Control display.

3 Use the CATEGORY [<<] and [>>] buttons to call up “Del SMPL.”

Del SMPL

4 Press the [0/EXECUTE] button.

5 Use the [+ /YES] and [- /NO] buttons to select the file name to delete.

6 Press the [0/EXECUTE] button.

“Del OK?” appears on the display.

7 Press the [0/EXECUTE] or [+ /YES] button again.

“Deleting” appears on the display and the sample is deleted from the USB flash drive.

8 Press the [FUNCTION] button to exit from the File Control display.

If the instrument is in the File Control display, no sound comes out even if you press the keyboard.

Recording Your Performance

You can record up to 10 of your performances to the instrument as **User Songs**. The recorded **User Songs** can be played back in the same way as the preset **Songs**.

NOTE

- For details on **Audio recording**, refer to page 41.
- This instrument records your performance and saves it in an original format. If you want to save it as **MIDI data**, convert it to **SMF** by saving it to the connected **USB flash drive** (page 74–75).

Track Structure of a Song

A Song can be recorded to the six tracks. You can record without specifying tracks, but you can also record each track one by one (e.g., only the right-hand part or the left-hand part) to create a complete piece which may be difficult to play at once.

● Melody Tracks [1/RIGHT]–[5]

These are for recording melody or similar performances.

● Accompaniment Track [A]

This is for recording a chord progression for the Style.

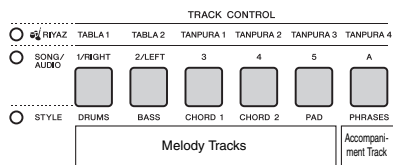

Track 1 will be selected as recording target of the melody, and the Track A will be selected as recording target of the accompaniment part (the chord progression for the Style automatically). If a User Song was selected beforehand, recording data will overwrite Tracks 1 and A of the selected Song.

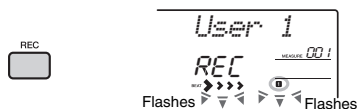

NOTE

- The **ACMP on/off status** cannot be changed after the **[REC]** button is pressed.

To exit from this status, press the **[REC]** button again.

4 Start recording.

- When you press the **[SONG]** button in step 2, play any note to start recording.
- When you select a Style in step 2, play a chord in the Auto Accompaniment area to start recording with Style playback, or press the **[▶/■]** (Start/Stop) button to start recording with playback of only the Rhythm part of a Style.

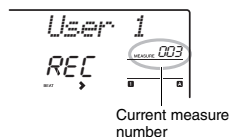

The current measure will be shown on the display while recording.

Quick Recording

This section explains how to record without specifying a track. This is useful when recording a new Song from scratch.

1 Make the desired settings including the Main Voice selection.

2 Make the desired settings for recording your performance.

- If you want to record only the melody performance, press the **[SONG]** button.
- If you want to record the performance using a Style, press the **[STYLE]** button.

3 Press the **[REC]** button to enter the Record Ready mode.

This operation selects the lowest-numbered unrecorded User Song from 061–070 (User 1–10) as the recording target.



5 Press the [▶/■] (Start/Stop) or [REC] button to stop recording.

When using a Style, you can stop recording also by pressing the [INTRO/ENDING/rit.] button, and then waiting until playback ends.

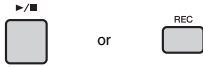

After recording finishes, "Writing!" appears indicating that the recorded data is being stored, and then the recorded track numbers in the display will light.

NOTICE

- Never attempt to turn the power off when "Writing!" is shown in the display. Doing so can result in a loss of data.

6 To play back the recorded Song, press the [▶/■] (Start/Stop) button.

NOTE

- When recording a performance with a Sample Voice, keep in mind that the Sample Voice itself is not recorded. For the performance to sound as you intended, you will need to assign that sample to the keyboard (the same as used when recording).
- If you fast forward or rewind during playback of a Song using Sample Voices, the playback sounds differ from the original recording.

Limitations while recording

- The on/off status of ACMP cannot be changed.
- Playback cannot be changed between Style and Riyaz.
- The Riyaz number can be changed while the Style number cannot.
- When you use Style/Riyaz, the following parameters cannot be changed: Reverb Type, Chorus Type, Time Signature and Style/Riyaz Volume.
- Performances with a Split Voice cannot be recorded.
- The audio input from an external device (playback sound on the connected computer or audio device) cannot be recorded.
- Performances using Sample Voices can be recorded on track 1 only.

Recording to a Specified Track

This section explains how to record to a specified track. This is useful when you want to record additional performances to an already recorded Song, or re-record only one track of an already recorded Song.

1 Press the [SONG] button, and then select the desired User Song from 061–070 (User 1–10) as the recording target.

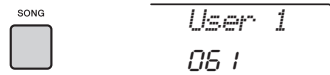

2 While holding down the [REC] button, press the desired Track button to enter the Record Ready mode.

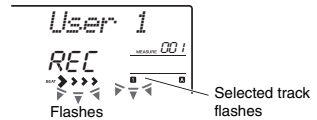

• If you want to record only the melody:

While holding down the [REC] button, press one of the [1/RIGHT]–[5] buttons.

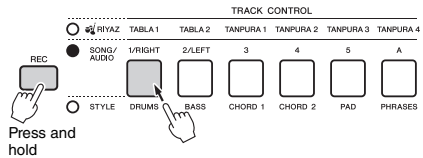

• If you want to record only the Style playback:

Press the [STYLE] button, select the desired Style, then simultaneously hold down the [REC] button and press the [A] button. ACMP is automatically turned on.

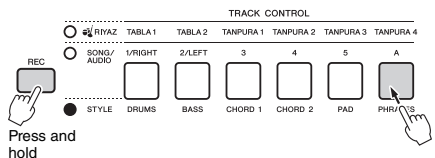

3 Same as in steps 4 to 6 (page 37) in “Quick Recording.”

NOTE

- If the memory becomes full while recording, an alert message will appear and recording will stop automatically. In this case, delete unnecessary data by using the Clear functions (below), and then execute the recording again.

Clearing a User Song

You can clear all tracks of a User Song.

- 1 Press the [SONG] button, then select the User Song from 061–070 (User 1–10) to be cleared.
- 2 Hold down the track [1/RIGHT] and [A] buttons simultaneously for longer than a second.

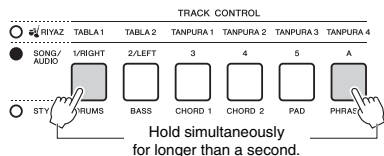

A confirmation message will appear on the display.



3 Press the [+ / YES] button.

A confirmation message will appear on the display. To cancel this operation, press the [-] button.

4 Press the [+ / YES] button to clear the Song.

An in-progress message will appear briefly on the display.

Clearing a Specified Track from a User Song

This lets you clear individual tracks from a User Song.

- 1 Press the [SONG] button, and then select the desired User Song from 061–070 (User 1–10).
- 2 From [1/RIGHT]–[5] and [A], press the Track button to be cleared for longer than a second.

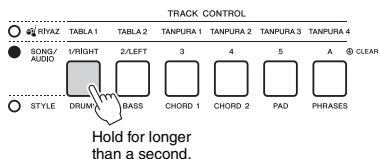

A confirmation message will appear on the display.



3 Press the [+ / YES] button.

A confirmation message will appear on the display. To cancel this operation, press the [-] button.

4 Press the [+ / YES] button to clear the track.

An in-progress message will appear briefly on the display.

Audio Playback and Recording

This instrument allows you to play back audio files and record your performances in audio format. The recorded performance can be saved to a USB flash memory as an audio file.

Audio file

An audio file is a recording of the performed sound itself. This data is recorded in the same way as that used in recording with voice recorders, etc. This data can be played with a portable music player, etc., allowing you to easily let other people hear your performance.

NOTE

- This instrument can record or play 44.1kHz/16-bit stereo WAV files.

Playing back an Audio File in a USB Flash Drive

You can playback audio files in a USB flash drive in the Audio mode.

While in the Audio mode, some operations cannot be executed. When you are not playing back or recording audio files, exit from the Audio mode.

NOTICE

- Do not disconnect the USB flash drive or turn off the power to the instrument during playback. Otherwise, damage to the data may occur.

1 Connect a USB flash drive to the [USB TO DEVICE] terminal.

For details, refer to “Connecting a USB Flash Drive” on page 72.

2 Press the [AUDIO] button to enter the Audio mode.

The audio file name, AUDIO icon and “PLY” appear on the display.

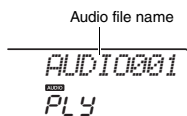

For example, the file named “AUDIO001.wav” in the USB flash drive is shown like this.

NOTE

- To exit from the Audio mode, press the [AUDIO] button again.

3 Rotate the dial to select the desired audio file.

You can also use the CATEGORY [<<] [>>] buttons, or the [+/YES] [-/NO] buttons. To instantly

jump to the first audio file, press the [+/YES] and [-/NO] buttons simultaneously.

4 Press the [▶/■] (Start/Stop) button to start playback of the audio file.

During playback, the time elapsed is shown on the display. To stop playback, press the [▶/■] (Start/Stop) button again.

NOTE

The following operations cannot be executed for audio playback.

- A-B Repeat
- Turning off “tracks” (page 60)
- Changing the tempo

5 Press the [AUDIO] button to exit from the Audio mode.

Message List

Message	Description
No USB	No USB flash drive is connected.
no file	There is no audio file in the USB flash drive.
Err Load	Cannot load the audio file because the format is not compatible with this instrument.
USB Err	The USB flash drive may have a problem. <ul style="list-style-type: none">• Refer to “Compatible USB Device List for PSR-I500” on the Yamaha website.• Format the USB Flash Drive.

Recording/Saving Audio Files to a USB Flash Drive

You can record your performance and save it as an audio file to the USB flash drive.

IMPORTANT

- Connect an AC adaptor to use this function.

NOTICE

- Do not disconnect the USB flash drive or turn off the power to the instrument during recording. Otherwise, damage to the data may occur.

1 Connect a USB flash drive to the [USB TO DEVICE] terminal.

For details, refer to “Connecting a USB Flash Drive” on page 72.

2 Make the desired settings of your performance.

Depending on the selected function, the data that can be recorded differs as follows.

- **When a Style is selected:**
Style, keyboard performance, audio input from the [AUX IN] jack
- **When a Riyaz is selected:**
Riyaz, keyboard performance, audio input from the [AUX IN] jack.
- **When a Song is selected:**
Keyboard performance, audio input from the [AUX IN] jack

NOTE

- Data that cannot be recorded includes: the metronome click, Songs, and audio input from the [USB TO HOST] terminal.

3 Hold the [AUDIO] button for longer than a second to enter the Audio mode (recording standby).

“PressREC” and the AUDIO icon appear on the display.

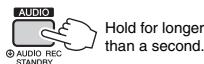

NOTE

- To exit from the Audio mode, press the [AUDIO] button again.

4 Press the [REC] button to start recording.

The elapsed time is shown on the display during recording.

The maximum recording time is 80 minutes or until the memory of the USB flash drive becomes full.

When stopping Style, press the [▶/■] (Start/Stop) button.

5 Press the [REC] button to stop recording.

“Writing!” appears indicating that the recorded data is being stored. After storing, “Compleat.” appears, and then the recorded audio file name will be shown as “AUDIO*****” (****: number).

NOTICE

- Never attempt to turn the power off when “Writing!” is shown in the display. Doing so can result in a loss of data.

6 Press the [▶/■] (Start/Stop) button to play back the recorded audio file.

7 Press the [AUDIO] button to exit from the Audio mode.

Message List

Message	Description
No USB	No USB flash drive is connected.
UseAdpt	No power is being drawn from batteries. Connect the AC adaptor.
File Ful	The total number of files in the USB flash drive exceeds the capacity. Delete unnecessary data or use another USB flash drive.
Unformat	The USB flash drive is unformatted. Format it (page 73).
Protect	The USB flash drive is protected. Set write-protect to off and try again.
Time Up	The recording time exceeds 80 minutes. The recording automatically stops and the audio file will be saved.
Disk Ful	Memory has become full. The recording is stopped and the audio file will be saved.
USB Err	The USB flash drive may have a problem. <ul style="list-style-type: none"> • Refer to “Compatible USB Device List for PSR-I500” on the Yamaha website. • Format the USB Flash Drive.

Deleting Audio Files from the USB Flash Drive

- 1 Connect a USB flash drive to the [USB TO DEVICE] terminal.
- 2 Hold the [FUNCTION] button for longer than a second to call up the File Control display.

If the instrument is in the Audio mode, press the [AUDIO] button to exit from the Audio mode, and then execute this operation.



- 3 Use the CATEGORY [<<] and [>>] buttons to call up “DeIAUDIO.”



- 4 Press the [0/EXECUTE] button.

Audio file names in the USB flash drive appear on the display as “AUDIO****” (****: number). Use the dial or the [+ /YES] [- /NO] button to select a different audio file.



- 5 Press the [0/EXECUTE] button again.

A confirmation message will appear. To cancel the operation, press the [- /NO] button.

- 6 Press the [0/EXECUTE] button again, or the [+ /YES] button to execute the Delete operation.

After a while, a message indicating completion of the operation appears.

NOTICE

- The Delete operation cannot be cancelled during execution. Never turn off the power or disconnect the USB flash drive during the operation. Doing so may result in data loss.

- 7 Press the [FUNCTION] button to exit from the File Control display.

Memorizing Your Favorite Settings (Registration Memory)

The Registration Memory function allows you to save (or “register”) panel settings such as Voice and Style to a Registration Memory button, and then instantly recall your custom panel settings by simply pressing a single button. The registered settings for four Registration Memory buttons will be saved as a single Bank.

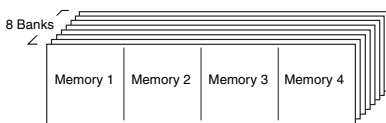

Up to 32 settings (eight banks of four each) can be memorized.

Memorizing Panel Settings to the Registration Memory

- 1 Make the desired settings, such as those for Voice, Style, and Riyaz.

NOTE

- Data cannot be saved to Registration Memory during Song playback.

- 2 Press the REGISTRATION MEMORY [BANK/MEMORY] button to call up a Bank number on the display.

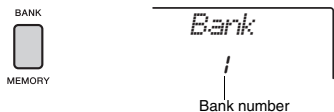

- 3 Use the dial or the [1]–[8] number buttons to select a Bank number.

NOTE

- By pushing the [BANK/MEMORY] button repeatedly, the Bank number can be changed in order from 1 to 8.

- 4 While holding down the [BANK/MEMORY] button, press one of the [1]–[4] buttons to memorize the current panel settings.

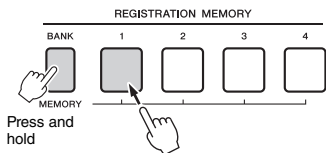

A “Mem OK” message appears indicating that the panel settings will be stored temporarily. The data is actually written to the memory when the power is turned off.

NOTICE

- If you select a Registration Memory number that already contains data, the previous data is deleted and overwritten by the new data.
- Samples are not memorized. Save them to a USB Flash Drive (page 35).

Recalling Panel Settings from the Registration Memory

- 1 Press and release the [BANK/MEMORY] button to call up a Bank number on the display.

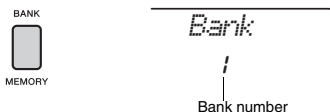

- 2 Use the dial or the [1]–[8] number buttons to select a Bank number.

NOTE

- By pushing the [BANK/MEMORY] button repeatedly, the Bank number can be changed in order from 1 to 8.

- 3 Press one of the REGISTRATION MEMORY [1]–[4] buttons to call up the panel settings you memorized.

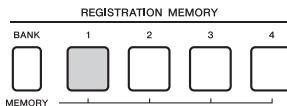

The recalled Registration Memory number appears in the display for a few seconds.

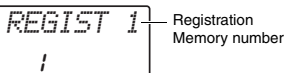

NEXT PAGE

NOTE

- When the [SONG] lamp is lit, the Style or Riyaz settings will not be recalled even if you press the [REGISTRATION MEMORY] button to which the Style or Riyaz settings are memorized. To recall Style/Riyaz settings, make sure to press the [STYLE] or [RIYAZ] button beforehand.
- For details about the parameters that can be memorized to Registration Memory, see the next page.

Parameters that can be memorized to Registration Memory

- **Style settings:** Style number, ACMP on/off, Style volume, Track on/off, Main section A/B, Tempo
- **Riyaz settings:** Riyaz number, Riyaz volume, Section (only Tabla), Track on/off (only Tabla), Tempo, Volume balance between Tabla 1 and 2, Volume balance between Tabla and Tanpura
- **Voice settings:**
 - **Main Voice settings:** Voice number and all settings of the related Functions (page 67)
 - **Dual Voice settings:** Dual on/off and all settings of the related Functions
 - **Split Voice settings:** Split on/off and all settings of the related Functions
- **Effect settings:** Reverb Type, Chorus Type
- **Harmony / Arpeggio settings:** Harmony/Arpeggio on/off and all settings of the related Functions
- **DSP:** DSP on/off, DSP type and parameter values of Knobs A/B.
- **Other settings:** Transpose, Pitch Bend Range, Knob Assign, Target, Split Point, Scale Tune

Freezing the Style settings even if a different Registration number is selected

If you want to select different Registration Memory setups without changing the Style settings or Riyaz settings, simultaneously hold down the [VOICE] button and press the REGIST MEMORY number button.

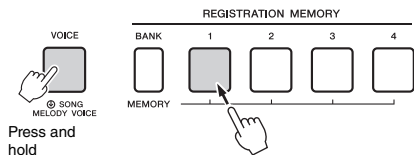

If you want to freeze the Style settings or Riyaz settings permanently, set the Freeze mode parameter to ON from Function display 069 (page 69).



Freezing the Transpose settings even if a different Registration number is selected

If you want to freeze the Transpose settings permanently, set the Freeze mode parameter to ON from Function display 070 (page 69).



Connecting to Other Devices

CAUTION

- Before connecting the instrument to external devices, turn off the power of all the devices. Also, before turning the power on or off, make sure to set all volume levels to minimum. Otherwise, damage to the devices or electrical shock may occur.

Connecting Headphones or an External Device

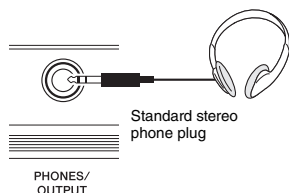

Connecting Headphones

Connect a pair of headphones to the [PHONES/ OUTPUT]/[PHONES] jack on the rear panel. The built-in speakers are automatically shut off when a plug is inserted into this jack.

Connecting an External Device

This jack also functions as an external output. By connecting to a computer, keyboard amplifier, recorder, or other audio device, you can output the audio signal of this instrument to that external device. The speakers of this instrument are automatically shut off when a plug is inserted into this jack.

CAUTION

- Do not use the headphones for a long period of time at a high or uncomfortable volume level, since this can cause permanent hearing loss.

NOTICE

- To avoid possible damage to the external device, first turn on the power to the instrument, then to the external device. When turning off the power, do so in reverse order: first turn off the power to the external device, then to the instrument.

Connecting a Footswitch to the SUSTAIN jack

You can produce a natural sustain as you play by pressing a footswitch (FC5 or FC4A; sold separately) plugged into the [SUSTAIN] jack. Although the footswitch works as the Sustain pedal for most Voices, it features other functions such as Sostenuto and Arpeggio Hold (for Voices 290–339). One of these functions can be assigned to the footswitch on the Function display (page 70).

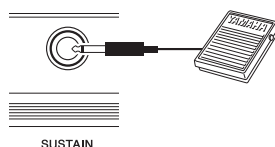

NOTE

- When Split is on, the sustain function does not affect the current Split Voice (page 20) while sostenuto and Arpeggio Hold (page 56) affect only the current Split Voice.
- Plug or unplug the footswitch while the power is off. Also, do not press the footswitch when turning the power on. Doing so changes the polarity of the footswitch, resulting in reversed operation.
- Some Voices may sound continuously or have a long decay after the notes have been released while the footswitch is held.

Playing an External Audio Device with the Built-in Speakers

By connecting an audio device such as a portable music player to the instrument's [AUX IN] jack, you can output the sound of the audio device through the built-in speakers of this instrument. This lets you play the keyboard along with the playback of your audio player, for practice or performance.

NOTICE

- To avoid damage to the devices, first turn on the power to the external device, and then to the instrument. When turning off the power, first turn off the power to the instrument, and then to the external device.

1 Connect the headphone jack of an audio device to the instrument's [AUX IN] jack by using an audio cable.

Audio device (portable music player, etc.)

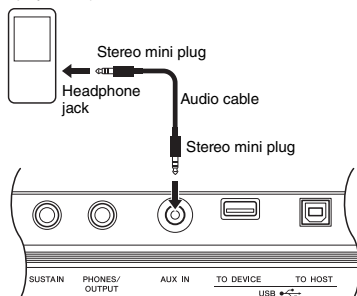

NOTE

- If you are using a computer or a smart device such as an iPhone/iPad, you can also connect it to the [USB TO HOST] terminal (see "Using with Computer or Smart Device," at right).

2 Turn on the audio device, and then this instrument.

3 Start play back of the connected audio device.

The sound of the audio device is output through the speakers of this instrument.

4 Adjust the volume balance between the audio device and this instrument.

Adjust the audio playback volume on the audio device, then adjust the entire volume by rotating

the [MASTER VOLUME] control of the instrument.

NOTE

- The audio input volume from the [AUX IN] jack can also be adjusted in the Function Settings (page 66, Function 004). If you increase the volume to more than 50, the audio device sound may be distorted.

5 Play the keyboard along with the sound of audio device.

NOTE

- You can cancel or lower the volume of the melody part of audio playback. For details, refer to page 46.

6 After finishing your performance, stop playback of the audio device.

Using the Melody Suppressor

When you output the audio sound of an external audio device or a computer connected to the [AUX IN] jack or the [USB TO DEVICE] or [USB TO HOST] terminal through this instrument, you can cancel or lower the volume of the melody part of audio playback. You can use the function to practice the melody part along with the audio playback.

1 Play back audio on the connected external device.

2 Press the [MELODY SUPPRESSOR] button to turn it on.

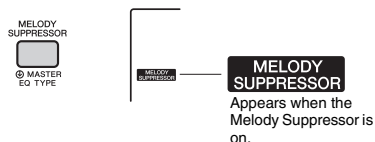

NOTE

- Depending on the particular music source, the melody or vocal sound may not be cancelled as expected even when if the Melody Suppressor is turned on. In such a case, try adjusting the pan position to be cancelled in the Function Settings (page 68, Function 041).
- When the instrument is connected to the [USB TO HOST] terminal, and Audio Loop Back (page 69, Function 058) is set to OFF, the Melody Suppressor function cannot be used.

3 Press the [MELODY SUPPRESSOR] button again to turn it off.

Using with Computer or Smart Device

Connecting the [USB TO HOST] terminal of this instrument and the computer or smart device allow you to use various function with just one USB cable, such as sending/receiving data with high sound quality, using the app of smart device, etc. The range of the instrument can do is extended. For details on using a computer or smart device, refer to the online PDF manual (page 11) "Computer-related Operations" or "iPhone/iPad Connection Manual."

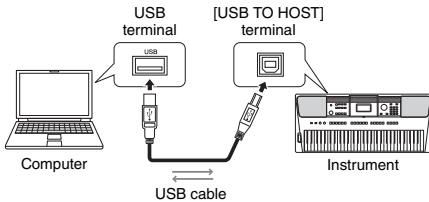

NOTICE

- Use an AB type USB cable of less than 3 meters. USB 3.0 cables cannot be used.
- If you are using a DAW (digital audio workstation) with this instrument, set the Audio Loopback (page 69) to OFF. Otherwise, a loud sound may occur, depending on the settings of the computer or the application software.

NOTE

- When using the Windows computer, install the Yamaha Steinberg USB Driver on the computer. For details, refer to the online PDF manual (page 11) "Computer-related Operations."

Transmit/Receiving MIDI data

When transmitting/receiving MIDI data, you can do the following as examples.

- **Playbacking MIDI data**
You can purchase data on the Yamaha website.
- **Recording the performance of the instrument as MIDI data**
You can edit the data, such as sound, pitch, etc. on music production software.
- **Using the external sound like a software synthesizer with keyboard on this instrument.**
You can performance with sounds other than built-in.

- **Using as a master keyboard to enter data on music production software or notation software.**

You can program on a music production software or enter notes on notation software.

NOTE

- For details of MIDI, refer to the online PDF manual (page 11) "MIDI Reference."

Sending/Receiving Audio data (USB Audio Interface)

When sending/receiving audio data by digital signal, you can do the following as examples.

- **Playbacking audio data with high sound quality**
You can enjoy clear sound that is less degradation of sound quality than connecting with [AUX IN] terminal.
- **Recording the performance of this instrument as audio data on recording software or music production software**
You can playback the recorded data with computer or smart device.

NOTE

- The volume can be adjusted on the computer or smart device, and also by using the instrument's [MASTER VOLUME] control.
- The audio data from computer or smart device cannot be played on the instrument in Quick Sampling mode or Audio mode.

Using Smart Device Apps

Using the smart device apps that are compatible with the instrument, you can do the following as examples.

- **Piano Diary**
You can leave the performance like diary.
- **Rec'n'Share**
You cannot only record the performance, but also share the data.

For details of the corresponding smart device or apps, refer to the Yamaha website.

Backup and Initialization

Backup Parameters

The following Backup parameters will be maintained even if the power is turned off.

Backup parameters (each time)

- User Songs (page 37)
- Style data transferred from a computer and loaded to Style numbers 283–292 (page 76)
- Assigned Sample to keyboards (page 33)

Backup parameters when turning off the power

- Registration Memory (page 44)
- FUNCTION Settings: (page 66)
 - Style Volume, Song Volume, Riyaz Volume, Audio Input Volume, Tuning, Split Point, Touch Response, Master EQ Type, Audio Loop Back on/off, Blank Cut on/off, Metronome Volume, Demo Group, Demo Play Mode, Auto Power Off Time, Battery Type, Language

In addition to the Backup parameters above, all the data (including Style data that have not been loaded) transferred from the connected computer will be maintained, even if you turn off the power.

NOTICE

Backup is executed automatically when the power is turned off. When the power is turned off in the following cases, backup is not executed.

- *Disconnected AC adaptor*
- *Power failure*
- *Low or no battery power*

Initializing the Instrument

You can erase the backup parameter settings described above, and then restore all the default factory settings. The instrument can be initialized with the following two methods.

Backup Clear

This operation initializes the backup parameters. While holding down the highest white key, press the [] (Standby/On) switch to turn the power on.

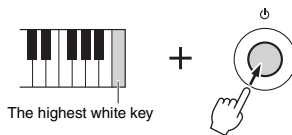

Flash Clear

This operation deletes all the Songs and Styles that have been transferred from a computer. Note that Style data loaded to Style numbers 283–292 will be maintained. While simultaneously holding the highest white key and the three highest black keys, press the [] (Standby/On) switch to turn the power on.

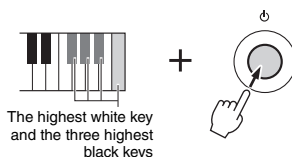

NOTICE

- *Keep in mind that this operation also deletes any data you have purchased and loaded. Be sure to save important data to a computer. For details, refer to the online PDF manual (page 11) "Computer-related Operations."*

Handy Performance Features

Selecting a Reverb Type

The Reverb effect lets you play with a rich concert hall type ambience.

Although selecting a Style or Song will call up the optimum Reverb type for the entire sound, you can select a different Reverb type manually.

1 Press the [FUNCTION] button.



2 Use the CATEGORY [<<] and [>>] buttons to call up “Reverb” (Function 038).

After a few seconds, the current Reverb type appears.

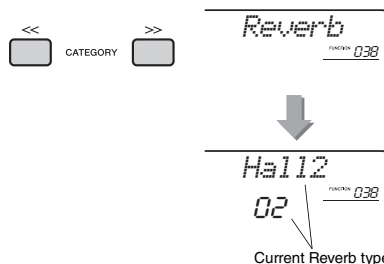

NOTE

- Some Songs and Styles use Reverb Types which cannot be selected via panel operation. If such a Song or Style is played back, “- -” is shown on the display.

3 Rotate the dial to select a Reverb type.

Play the keyboard to check the sound. For information about the available Reverb types, refer to the Effect Type List in the separate Data List.

Adjusting the Reverb depth

You can adjust the Reverb depth applied to the Main, Dual, and Split Voices individually via the same operations above. Regarding the item in step 2, refer to the Function List on page 67.

Selecting a Chorus Type

The Chorus effect creates a thick sound that sounds like many of the same Voices being played in unison.

Although selecting a Style or Song will call up the optimum Chorus type for the entire sound, you can select a different Chorus type manually.

1 Press the [FUNCTION] button.



2 Use the CATEGORY [<<] and [>>] buttons to call up “Chorus” (Function 039).

After a few seconds, the current Chorus type appears.

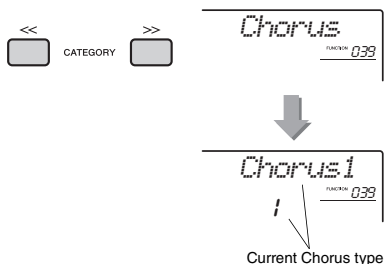

NOTE

- Some Songs and Styles use Chorus Types which cannot be selected via panel operation. If such a Song or Style is played back, “- -” is shown on the display.

3 Rotate the dial to select a Chorus type.

Play the keyboard to check the sound. For information about the available Chorus types, refer to the Effect Type List in the separate Data List.

Adjusting the Chorus depth

You can adjust the Chorus depth applied to the Main, Dual, and Split Voices individually via the same operations above. Regarding the item in step 2, refer to the Function List on page 67.

Pitch Controls—Transpose

The overall pitch of the instrument (except for the Drum Kit Voices and Sample Voice) can be shifted up or down by a maximum of 1 octave in semitone increments.

- 1 Press the [TRANPOSE] button to call up “Transpose” (Function 006).

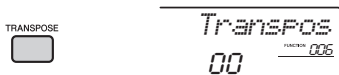

- 2 Use the dial to set the Transpose value between -12 and +12.

Pitch Controls—Fine Tuning

The overall tuning of the instrument (except for the Drum Kit Voices) can be shifted up or down between 427.0 Hz and 453.0 Hz in approximately 0.2 Hz increments. The default value is 440.0 Hz.

- 1 Press the [FUNCTION] button.



- 2 Use the CATEGORY [<<] and [>>] buttons to call up “Tuning” (Function 007).

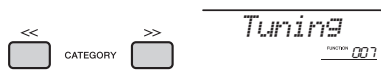

- 3 Use the dial to set the Tuning value.

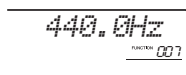

Pitch Controls—the [PITCH BEND] wheel

The [PITCH BEND] wheel can be used to add smooth pitch variations to notes you play on the keyboard. Roll the wheel upward to raise the pitch, or downward to lower the pitch.

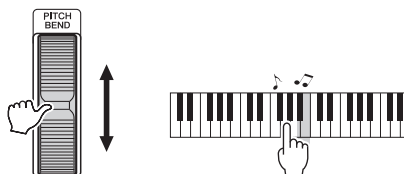

You can change the amount of pitch bend produced by the wheel in the Function Settings (page 66, Function 008).

Using Portamento

Portamento is a function that creates a smooth transition in pitch from the first note played on the keyboard to the next.

Using this function effectively provides even greater expressive nuance to your performance.

- 1 Press the [FUNCTION] button.



- 2 Use the CATEGORY [<<] and [>>] buttons to call up “Port.” (Function 011).

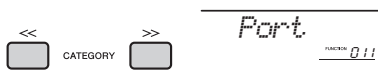

- 3 Press the [+ / YES] or [- / NO] button to switch the function on or off.

NOTE

- The default setting is OFF.
- Due to the characteristics of the Portamento function, little or no change in pitch may result when playing short notes, or when using a Voice with an extremely short decay time.
- When using Quick Sampling (page 32) or with a specific effect sound (Instrument number 802 [Smpl Vce]), Portamento will not be applied to the sample sounds assigned to Sample Zones B to E of the keyboard.

Setting the Portamento time

Select from 127 levels of the Portamento time (the time it takes from transitioning one note to another) for the Portamento function.

1 Press the [FUNCTION] button.



2 Use the CATEGORY [<<] and [>>] buttons to call up “PortTime” (Function 012).

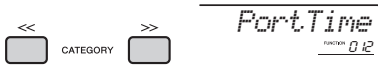

3 Press the [+ / YES] or [- / NO] button to switch the function on or off.

NOTE

- The default value is set to 64.
- In order to set Portamento Time, the Portamento (function number 011) setting must be on.

Calling Up Optimum Panel Settings—One Touch Setting (OTS)

Select a Song, Style or Riyaz by pressing the [SONG], [STYLE] or [RIYAZ] button, and then select Voice number 000 OTS (page 19). This lets you automatically call up the optimum panel settings such as Voice and tempo for the current Song, Style or Riyaz.

Changing the Touch Response of the Keyboard

The keyboard of this instrument is equipped with a Touch Response feature that lets you dynamically and expressively control the level of the Voices according to your playing strength.

1 Press the [FUNCTION] button.



2 Use the CATEGORY [<<] and [>>] buttons to call up “TouchRes” (Function 010).

After a few seconds, the current Touch Response appears.

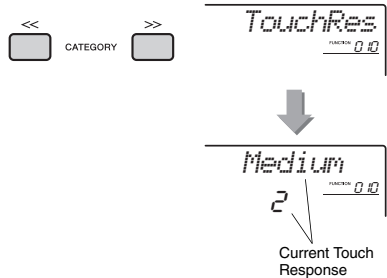

3 Use the dial to select a Touch Response setting between 1 and 4.

Touch Response

1	Soft	Allows maximum loudness to be produced with relatively light key pressure.
2	Medium	Produces a fairly “standard” keyboard response.
3	Hard	Requires strong playing to produce high volume.
4	Fixed	All notes are produced at the same volume no matter how hard the keyboard is played.

Selecting an EQ Setting for the Best Sound

Six different master equalizer (EQ) settings give you the best possible sound when listening through different reproduction systems—the instrument’s internal speakers, headphones, or an external speaker system.

1 Hold down the [MELODY SUPPRESSOR] button for longer than a second to call up “Master EQ” (Function 040).

After a few seconds, the current Master EQ type appears.

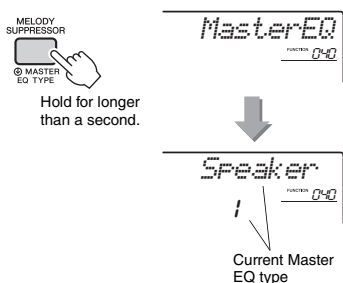

2 Rotate the dial to select the desired Master EQ type.

Master EQ types

1	Speaker	Optimum for listening via the instrument’s built-in speakers.
2	India	Optimum for listening via external speakers. The mid-range is slightly cut, to better emphasize the characteristics of the Indian instrument sounds, resulting in clear and more powerful sounds.
3	Headphone	Optimum for headphones, or for listening via external speakers.
4	Boost	Results in more powerful sound. Depending on the selected Voice and Style, etc., the sound may be more subject to distortion than other EQ types.
5	Piano	Optimum for piano solo performance.
6	Bright	Lowers the mid range for a brighter sound.

Scale Tuning

By default, the scale of this keyboard is set to Equal Temperament — the same tuning as with any acoustic piano. However, the setting can be changed to any other scale according to the music genre or style in which you want to play.

Selecting a Scale

You can select a desired scale among the various preset scales.

- 1 Press the [FUNCTION] button.



- 2 Use the CATEGORY [<<] and [>>] button to call up “Scale” (Function 048).

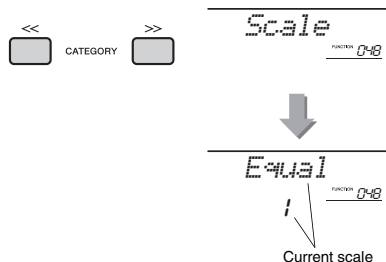

- 3 Rotate the dial to select a scale.

The default setting is “1 Equal.”

Preset Scale types

1	Equal
2	Pure Major
3	Pure Minor
4	Bayat (Arabic)
5	Rast (Arabic)

Setting the Base Note for Each Scale

Make sure to specify the appropriate base note, if you select a scale other than Equal Temperament, or create an original scale via Scale Tune function.

- 1 Press the [FUNCTION] button.



- 2 Use the CATEGORY [<<] and [>>] button to call up “BaseNote” (Function 049).

After a few seconds, the current base note appears.

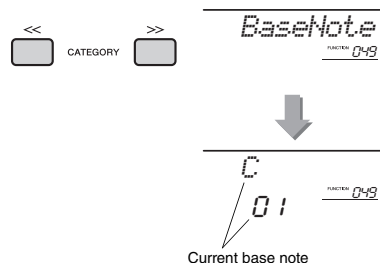

- 3 Rotate the dial to select a base note from C, C#, D, E♭, E, F, F#, G, A♭, A, B♭ and B.

The default setting is “C.”

Tuning Each Note to Create an Original Scale

You can tune the individual notes in cents (a “cent” is 1/100th of a semitone) to create your own original scale.

1 Press the [FUNCTION] button.



2 Use the CATEGORY [<<] and [>>] buttons to call up “TuneNote” (Function 050).

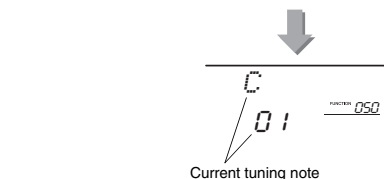
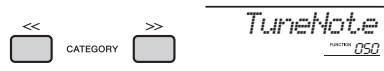

3 Rotate the dial to select the note to be tuned from C, C#, D, E♭, E, F, F#, G, A♭, A, B♭, B.

4 Press the CATEGORY [>>] button to call up “Tune” (Function 051).

After a few seconds, the tuning value of the note selected in step 3 appears.

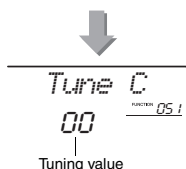
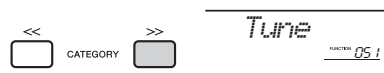

5 Rotate the dial to tune the note over a range of -64 to +63.

The setting can be reset to the initial default value by pressing the [+ / YES] and [- / NO] buttons simultaneously.

6 Repeat steps 2–5 as desired.

7 Memorize the settings here to a Registration Memory as desired (page 43).

NOTE

- When pressing the [+ / YES] and [- / NO] buttons simultaneously after recalling an original scale memorized to Registration Memory, the scale will return to the original scale registered to Registration Memory, not to the default tune value.
- When calling up “Scale” (Function 048) after using individual note scale tuning, “(Edited)” will be shown in the display. However, the edited scale settings will be erased by calling up another scale. For this reason, the edited settings should be memorized to Registration Memory.

Voice Settings

Selecting a Dual Voice

- 1 Hold down the [DUAL] button for longer than a second to call up “D.Voice” (Function 022).

After a few seconds, the current Dual Voice appears.

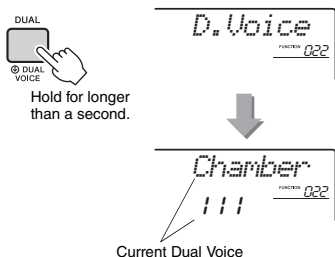

- 2 Rotate the dial to select the desired Dual Voice.

Selecting a Split Voice

- 1 Hold down the [SPLIT] button for longer than a second to call up “S.Voice” (Function 032).

After a few seconds, the current Split Voice appears.

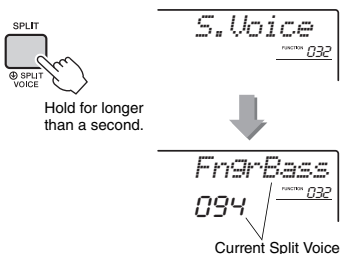

- 2 Rotate the dial to select the desired Split Voice.

Voice Editing

Each of the Main, Dual and Split Voices can be edited, with available parameters including volume, octave and Reverb/Chorus depth—allowing you to create new, custom sounds to best suit your own musical preferences.

- 1 Press the [FUNCTION] button.



- 2 Use the CATEGORY [<<] and [>>] buttons to call up the desired item.

Voice parameters are indicated as below.

- Main Voice parameters: M.***** (Function 013–021)
- Dual Voice parameters: D.***** (Function 022–031)
- Split Voice parameters: S.***** (Function 032–037)

For details on each parameter, refer to the Function List on page 67.

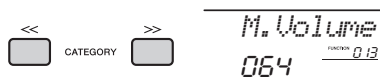

- 3 Rotate the dial to set the value.

Check the sound by playing the keyboard.

- 4 Repeat steps 2–3 above to edit various parameters.

- 5 If necessary, memorize the settings to a Registration Memory (page 43).

The Voice-related settings are reset when a different Voice is selected. If you want to store the created sound for future recall, memorize the settings to a Registration Memory.

Arpeggio Settings

Synchronizing an Arpeggio to Song/Style/Riyaz Playback— Arpeggio Quantize

When you play the keyboard to trigger an Arpeggio (page 21) along with Song/Style/Riyaz playback, you'll need to play the notes with correct timing to keep the Arpeggio in synchronization with the other playback tracks. However, your actual timing may be slightly ahead of or behind the beat (or both). The "Arpeggio Quantize" function of this instrument will correct any slight imperfections in the timing (according to settings below), and then play back the Arpeggio appropriately.

- No synchronization
- Synchronizing to 8th notes
- Synchronizing to quarter notes

Although the Arpeggio Quantize value is pre-programmed for each Arpeggio Type, you can change the value manually.

1 Press the [FUNCTION] button.



2 Use the CATEGORY [<<] and [>>] buttons to call up the "Quantize" (Function 047).

After a few seconds, the current Arpeggio Quantize value appears.

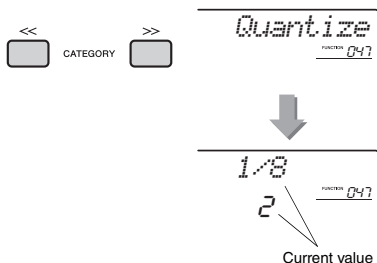

3 Rotate the dial to select a value from "OFF," "1/8" and "1/16."

- OFF No synchronization
- 1/8 Synchronizing to quarter notes
- 1/16 Synchronizing to 8th notes

Holding the Arpeggio Playback via the Footswitch

You can set the instrument so that Arpeggio playback continues even after the note has been released, by pressing the footswitch connected to the [SUSTAIN] jack.

1 Press the [FUNCTION] button.



2 Use the CATEGORY [<<] and [>>] buttons to call up "Pd1 Func" (Function 073).

After a few seconds, the current pedal setting appears.

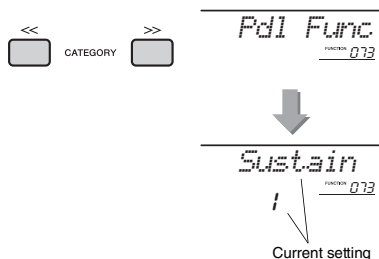

3 Rotate the dial to select "Arp Hold."

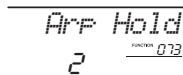

If you want to restore the footswitch function to sustain, select "Sustain." If you want to use both hold and sustain functions, select "Sus+ArpH."

4 Try playing the Arpeggio with the footswitch.

Press the notes to trigger the Arpeggio, then press the footswitch. Even if you release the notes, Arpeggio playback will continue. To stop Arpeggio playback, release the footswitch.

Parameters Assigned to the Knobs

This section describes each of the parameters which can be assigned to the Knobs (page 24).

1 RIYAZ BALANCE

Knob A adjusts the volume balance between the sounds of Tabla 1 and 2, while Knob B adjusts the volume balance between the sounds of Tabla and Tanpura.

2 RIYAZ TEMPO/RIYAZ KEY

Knob A adjusts the tempo of Tabla playback while the Tanpura playback tempo is maintained. This follows typical Indian music stylistic conventions. Knob B raises or lowers the pitch of the Riyaz sound in semitones, with the exception of Tabla 1. This accurately simulates the characteristics of the Tabla, in which the lower sound is not affected by the tuning. Note that also the pitch of Tabla 2 may not be changed depending on the Riyaz pattern.

NOTE

- When Knob B is turned all the way left, only the pitch of the Tabla 2 sound is raised abruptly by an octave. This is due to a limitation in this instrument.

3 CUTOFF/RESONANCE

These effects shape the sound by allowing only a specified range of frequencies to pass and/or by producing a resonance peak at the “cutoff” frequency. These effects can be used to create a range of synthesizer-like sounds.

NOTE

- When the target is KEYBOARD, these effects are applied to the Main/Dual Voices. When the target is BACKING, these effects are applied to the Styles and Riyaz patterns.
- These effects can sometimes cause distortion, especially in the bass frequencies.

Knob A: CUTOFF

Adjusts the cutoff frequency, and therefore the brightness of the sound. Turning the knob to the left makes the sound more muffled or darker, while turning the knob A to the right makes the sound brighter.

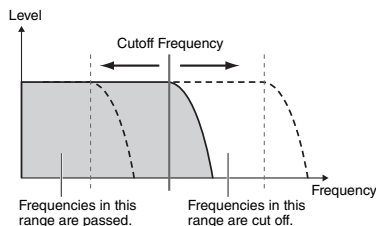

Knob B: RESONANCE

Adjusts the amount of Resonance applied at the cutoff frequency. Turning the knob to the right increases the Resonance to emphasize the frequencies at the cutoff frequency, resulting in an exaggerated peak.

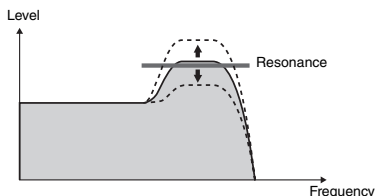

4 REVERB/CHORUS

Knob A: REVERB

Reproduces the acoustic ambience of a concert hall or club. Turning the knob to the right increases the Reverb depth.

Knob B: CHORUS

Produces a rich and warm layered effect. Turning the knob to the right increases the Chorus depth.

NOTE

- When the target is KEYBOARD, these effects are applied to the Main/Dual Voices. When the target is BACKING, these effects are applied to the Styles and Riyaz patterns.

5 DSP

Knob A/B: DSP PARAMETER A/B

With the digital effects built into the instrument, you can add DSP effects to your keyboard performance and the playback sound of Styles, etc. (page 23). Each effect has two parameters which are assigned to Knobs A and B. By turning the knobs in real-time, you can alter the music in various dynamic ways, such as changing the rotating speed (slow/fast) of the rotary speaker or changing the degree of the Distortion.

6 ATTACK/RELEASE

These effects determine how the level of the sound varies over time. You can make the attack faster for a more percussive sound or slower for a violin-like sound, for example. Or you can lengthen or shorten the sustain to best match the music you're playing.

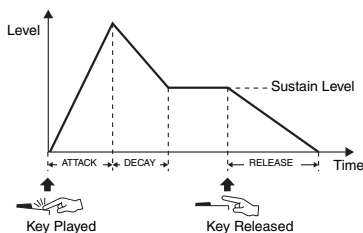

● Knob A: ATTACK

Adjusts the Attack Time (the amount of time it takes the sound to reach maximum level when a key is played). Turning the knob to the right increases the Attack Time, thus slowing down the attack rate.

● Knob B: RELEASE

Adjusts the Release Time (the amount of time it takes for the sound to decay to silence after a key is released). Turning the knob to the right increases the Release Time, thus making a longer sustain.

NOTE 1

- These effects are applied only to KEYBOARD. The target cannot be switched to BACKING.

The chart below lists some interesting ways to use the various effects that can be assigned to the knobs.

Some Ideas for Using the Knobs

Number/Effect		Try This
1	RIYAZ BALANCE	Knob A adjusts the volume balance between the sounds of Tabla 1 (having the lower sound) and Tabla 2 (having the higher sound of Tabla or Mridangam). Knob B adjusts the volume balance between the sounds of the Tabla (assigned to the [TABLA 1] and [TABLA 2] buttons) and Tanpura (assigned to the [TANPURA 1]–[TANPURA 4] buttons). Play with these Knobs as the patterns loop, sing along if you wish, and create your own performance.
2	RIYAZ TEMPO/RIYAZ KEY	Knob A adjusts the tempo of Riyaz playback. Setting to the minimum left-most position results in half the default tempo, while setting to the maximum right-most position results in double the default tempo. The center position corresponds to the default tempo. Note that the tempo cannot exceed the range (11–280), and that the tempo of the Tanpura patterns will not change even if you rotate Knob A. Knob B raises or lowers the pitch of the Riyaz sound in semitones. Regarding the Tabla, only the higher sound (assigned to the [2] button) will be transposed. Rotating the knob leftward lowers the pitch while rotating the knob rightward raises the pitch. NOTE 1 • The pitch of Tabla 2 may not be changed depending on the Riyaz pattern. Use these knobs to set the desired tempo and key, sing along if you wish, and create your own performance!
3	CUTOFF/RESONANCE	Select “183 Gemini” (a synth-lead type Voice) or “210 Noise.” Select 3 with [KNOB ASSIGN] button, and then switch the target to KEYBOARD. Turning Knobs A or B while playing gives you the dynamic filter-sweep effects of an analog synthesizer.
4	REVERB/CHORUS	Select the Voice “048 CP80.” Select 4 with [KNOB ASSIGN] button, and then switch the target to KEYBOARD. Turn Knobs A and B all the way down to hear the direct, unprocessed sound of the Voice. As you turn Knob B toward the right, a Chorus effect with modulation is gradually applied to the sound. Turning Knob A to the right adds a Reverb effect that makes you sound like you are playing in a concert hall.
5	DSP	Select the Voice, “059 Cool!Org.” Select 5 with [KNOB ASSIGN] button, and then switch the target to KEYBOARD. Press the [DSP] button to turn the DSP on, then set the DSP type (Function 042) to “01 RotarySp.” Use Knob A to change the rotating speed of the rotary speaker while playing the keyboard. When you move it slowly, you can create gradual speed changes like on a real rotary speaker. Use Knob B to control the distortion.
6	ATTACK/RELEASE	Select the Voice “213 RSAnPad.” Turning Knob A all the way down makes the attack faster, and lets you hear the crisp, clear sound of the original Voice. Turning Knob B all the way down shortens the amount of time for the sound to decay to silence after a key is released. These knobs let you finely adjust the Voice to create the appropriate sound for the particular song you’re playing.

Styles and Riyaz Patterns

Style Variations—Sections

Each Style consists of “Sections” that allow you to vary the arrangement of the accompaniment to match the song you are playing.

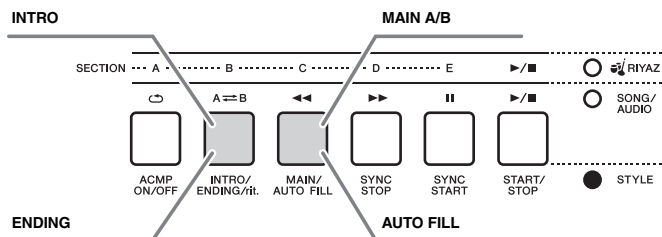

INTRO

This is used for the beginning of the Song. When the Intro finishes, Style playback shifts to the Main section. The length of the Intro (in measures) differs depending on the selected Style.

MAIN

This is used for playing the main part of the Song. Playback of the Main section repeats indefinitely until another Section's button is pressed. There are two variations (A and B), and the Style playback sound changes harmonically in response on the chords you play with your left hand.

AUTO FILL

This is automatically added before changing to Main A or B.

ENDING

This is used for the ending of the Song. When the Ending finishes, the Style playback stops automatically. The length of the Ending (in measures) differs depending on the selected Style.

1 Press the **[STYLE]** button, then rotate the dial to select a Style.

2 Press the **[ACMP ON/OFF]** button to turn **ACMP** on.

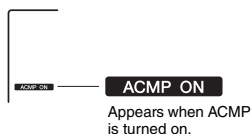

3 Press the **[SYNC START]** button to turn **Synchro Start** on.



To turn off Synchro Start, press the **[SYNC START]** button.

Synchro Start

When Synchro Start is on, Style playback will begin as soon as you play a chord in the Auto Accompaniment area of the keyboard.

4 Press the **[MAIN/AUTO FILL]** button to select **Main A** or **Main B**.

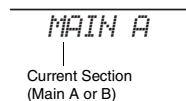

5 Press the [INTRO/ENDING/rit.] button.

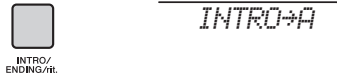

Now, you're ready to start Style playback of the Intro and then the Main A (or B) section.

6 Play a chord with your left hand to start playback of the Intro.

For information on how to play chords, see "Chords" on page 63.

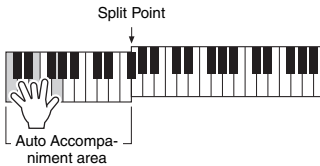

7 After the Intro finishes, play the keyboard according to the progression of the Song you are playing.

Play chords with your left hand while playing melodies with your right hand, and press the [MAIN/AUTO FILL] button as necessary. The Section will change to Fill-in then Main A or B.

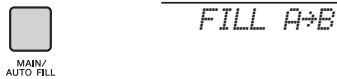

8 Press the [INTRO/ENDING/rit.] button.



The Section switches to the Ending. When the Ending is finished, Style playback stops automatically. You can have the Ending gradually slow down (ritardando) by pressing the [INTRO/ENDING/rit.] button again while the Ending is playing back.

NOTE

- Style numbers 258, 270–282 have no rhythm parts, so no rhythm will play. When one of these Styles is selected, turn ACMP on, then specify the chord in the Auto Accompaniment area to play Style parts other than the Rhythm part.

Style Synchro Stop

When you press the [SYNC STOP] button to turn on this function, the Style will only play while pressing chords in the Auto Accompaniment area of the keyboard. Releasing all the notes will stop Style playback.

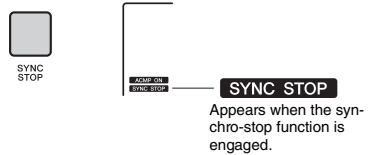

NOTE

- This function can be used when ACMP is turned on.

Turning Each Style Track On/Off

As printed on the front panel, a Style consists of six tracks. Turn on/off each track via the TRACK CONTROL buttons. Each of the tracks can be muted so that you can play the muted part yourself. Pressing the desired Track button repeatedly will toggle the on/off status.

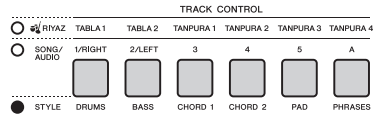

1 2 3 4 5 6 — On/off status is shown in the display (page 18)

NOTE

- Up to two Track buttons can be pressed simultaneously for turning Tracks on or off.

Riyaz Variations

Each Riyaz features five Variations A–E via the Tabla sound. These five variations can be alternated via the [A]–[E] buttons during playback, allowing you to add dynamic variations to the performance.

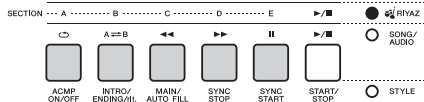

In addition, four phrase variations via the Tanpura sound are provided commonly for all the Riyaz patterns. These four variations can be alternated via the TANPURA 1–4 buttons.

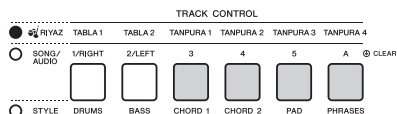

Unlike the Styles, the Riyaz patterns do not have the variations dedicated to the beginning or ending of the Song, such as Intro and Ending. The Riyaz playback will continue until stopped manually.

Changing the Tempo

A Style or Riyaz can be played at any tempo you desire—fast or slow—and the tempo can be changed precisely.

- 1 Press the [TEMPO/TAP] button to call up the Tempo value in the display.

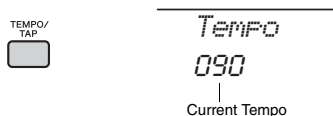

- 2 Rotate the dial to set a tempo from 011 to 280.

Pressing the [+ / YES] and [- / NO] buttons simultaneously can instantly reset the value to the default tempo of the current Style or Riyaz. You can change the tempo during playback by pressing the [TEMPO/TAP] button just twice at the required tempo.

NOTE

- The above operation applies also to Song or Arpeggio playback tempo.

Tap Start

You can start play back of the Style, Riyaz or Song by simply tapping the [TEMPO/TAP] button at the required tempo—four times for time signatures in 4 (4/4, etc.), and three times for time signatures in 3 (3/4, etc.).



NOTE

- Tap tempo setting range: 32–280

Adjusting the Volume of the Style or Riyaz

You can adjust the volume balance between Style or Riyaz playback and your keyboard performance.

1 Press the [FUNCTION] button.



2 Use the CATEGORY [<<] and [>>] buttons to call up “StyleVol” (Function 001) or “RiyazVol” (Function 003).

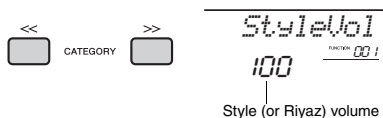

3 Rotate the dial to set the volume between 000 and 127.

Setting the Split Point

The point on the keyboard that separates the left-hand area and the right-hand area of the keyboard is called the “Split Point.” The left-hand area is used to specify the chord for Style playback, or to play the Split Voice.

The default Split Point is key number 054 (the F#2 key), but you can change it to another key.

1 Press the [FUNCTION] button.



2 Use the CATEGORY [<<] and [>>] buttons to call up “SplitPnt” (Function 009).

You can call up this display also by pressing the [STYLE] then holding the [ACMP] button for longer than a second.

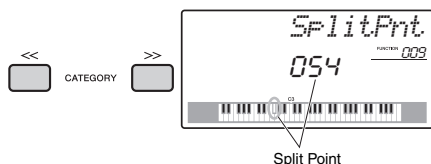

3 Rotate the dial to set the Split Point between 036 (C1) and 096 (C6).

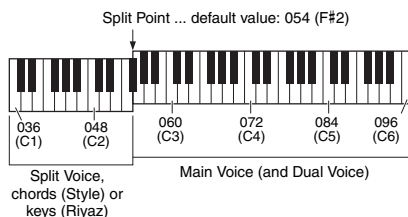

Playing Chords Without Style Playback (Stop Accompaniment)

If you press the [STYLE] button, press the [ACMP ON/OFF] button to turn ACMP on (the ACMP ON icon appears), and play the chord in the Auto Accompaniment area of the keyboard (with SYNC START off), the chord sound will be heard without Style playback. This is referred to as “Stop Accompaniment.”

The specified chord will be shown in the display, and affects the Harmony function (page 21).

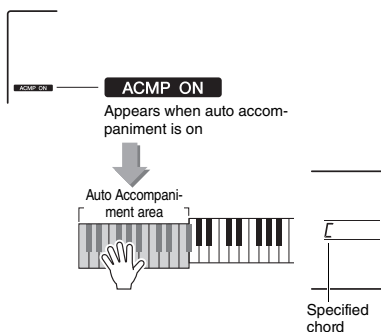

Chord Types for Style Playback

For users who are new to chords, this chart features common chords. Since there are many useful chords and many different ways to use them musically, refer to commercially available chord books for further details.

★ indicates the root note.

Major	Minor	Seventh	Minor Seventh	Major Seventh
C 	Cm 	C7 	Cm7 	CM7
D 	Dm 	D7 	Dm7 	DM7
E 	Em 	E7 	Em7 	EM7
F 	Fm 	F7 	Fm7 	FM7
G 	Gm 	G7 	Gm7 	GM7
A 	Am 	A7 	Am7 	AM7
B 	Bm 	B7 	Bm7 	BM7

- Inversions can be used as well as in "root" position—with the following exceptions: m7, m7♭5, m7(11), 6, m6, sus4, aug, dim7, 7♭5, 6(9), sus2
- Inversion of the 7sus4 chords are not recognized if the notes are omitted.
- When playing a chord which cannot be recognized by this instrument, nothing is shown on the display. In such a case, only the rhythm and bass parts will be played.

Easy Chords

This method lets you easily play chords in the Auto Accompaniment area of the keyboard using only one, two, or three fingers.

For root "C"



To play a major chord
Press the root note (★) of the chord.



To play a minor chord
Press the root note together with the nearest black key to the left of it.



To play a seventh chord
Press the root note together with the nearest white key to the left of it.



To play a minor seventh chord
Press the root note together with the nearest white and black keys to the left of it (three keys altogether).

Song Settings

Background Music Playback

With the default setting, pressing the [DEMO] button will play back only a few of the internal Songs repeatedly. This setting can be changed so that, for example, all internal Songs are played, or all Songs transferred to the instrument from a computer are played back, letting you use the instrument as a background music source. Six playback group settings are provided for your listening pleasure.

1 Hold down the [DEMO] button for longer than a second to call up “DemoGrp.”

After a few seconds, the current repeat playback group appears.

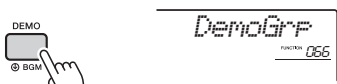

Hold for longer than a second.

2 Rotate the dial to select a repeat playback group from the table below.

Demo	Preset Songs 001–003
Preset	All preset Songs
User	All User Songs
Download	All Songs transferred from a computer
USB	All Songs (MIDI files) in the connected USB flash drive
AUDIO	All audio Songs in the connected USB flash drive

NOTE

- When there are no existing User Songs, Download Songs or USB Songs in the data, the Demo Songs are played back.

3 Press the [DEMO] button to start playback.

To stop playback, press the [DEMO] button again.

Random Song Playback

The order of Song repeat playback via the [DEMO] button can be changed between numerical order and random order.

1 Press the [FUNCTION] button.



2 Use the CATEGORY [<<] and [>>] buttons to call up “PlayMode” (Function 067).

After a few seconds, the current playback mode appears.

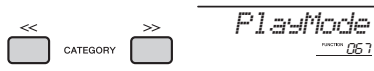

When the DemoGrp is set to “Demo,” this parameter cannot be set.

3 Rotate the dial to select “Random.”

To return to the numerical order, select “Normal.”

4 Press the [DEMO] button to start playback.

To stop playback, press the [DEMO] button again.

Tempo Setting of the Song

This operation is same as that of the Style and Riyaz. Refer to page 61.

NOTE

- Tempo of audio Song cannot be changed.

Tap Start

This operation is same as that of the Style and Riyaz. Refer to page 61.

Song Volume

- Press the [FUNCTION] button.



- Use the CATEGORY [<<] and [>>] buttons to call up "SongVol" (Function 002).

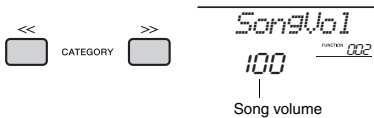

- Rotate the dial to set the Song volume between 000 and 127.

NOTE

- Song volume can be adjusted while in the Song mode.

Melody Voice Setting of the Preset Song

You can change the Melody Voice of the current Preset Song and Song from the external device temporarily to any other desired Voice.

- Press the [SONG] button, select the desired Preset Song, and then start playback (page 27).
- Press the [VOICE] button, then rotate the dial to select the desired Voice.

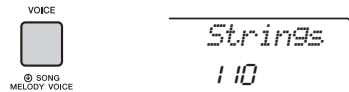

- Hold down the [VOICE] button for longer than a second to call up "SONG MELODY VOICE."

After a few seconds, the Melody Voice of the Song will be changed to that selected in step 2.

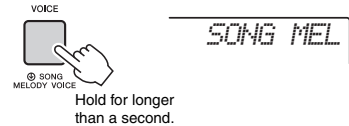

NOTE

- Selecting another Song will cancel the changed Melody Voice.
- You cannot change the Melody Voice of a User Song.
- Other Voice will be changed depending on Song.
- You cannot change the Voice of an audio data.

The Functions

The “Functions” provide access to a range of detailed instrument parameters such as Tuning, Split Point, Voices and Effects. Find the desired item in the Function List on pages 66–70, and then follow the instructions below.

Basic Procedure in the Function Display

1 Press the [FUNCTION] button.



2 Press the CATEGORY [<<] and [>>] button several times until the desired item appears.

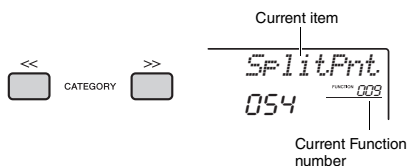

3 Use the dial, the [+ / YES] and [- / NO] buttons, or the [0]–[9] number buttons to set the value of the selected function.

To restore the default value, press the [+ / YES] and [- / NO] buttons simultaneously. The one exception to

this is the MIDI Initial Send function (Function 057), which is an operation and not a parameter. For this function, pressing the [+ / YES] button executes the operation while pressing [- / NO] cancels it.

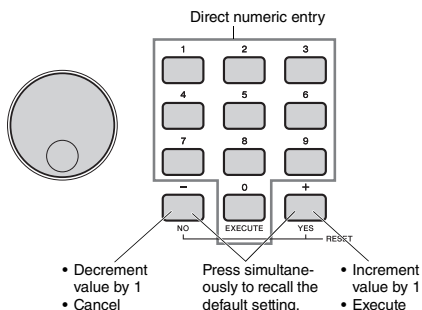

Some Function settings are maintained even if you turn off the power, and can be transferred to a computer as Backup Data (page 48).

NOTE

- To exit from a Function display, press the [VOICE], [STYLE], [SONG] or [RIYAZ] button.

Function List

Function Number	Function	Display	Range/Settings	Default Value	Description
Volume					
001	Style Volume	<i>StyleVol</i>	000–127	100	Refer to page 62.
002	Song Volume	<i>SongVol</i>	000–127	100	Refer to page 65.
003	Riyaz Volume	<i>RiyazVol</i>	000–127	100	Refer to page 62.
004	[AUX IN] Audio Volume	<i>AuxInVol</i>	000–127	50	Adjusts the volume of audio playback that is input from the [AUX IN] jack (pages 32, 46).
005	[USB TO DEVICE] [USB TO HOST] Audio Volume	<i>USBInVol</i>	000–127	100	Adjusts the volume of audio playback that is input from the [USB TO DEVICE] and [USB TO HOST] terminal (pages 40, 47).
Overall					
006	Transpose	<i>TransPos</i>	-12–12	00	Refer to page 50.
007	Tuning	<i>Tuning</i>	427.0Hz–453.0Hz	440.0Hz	Refer to page 50.
008	Pitch Bend Range	<i>PBR</i> ange	01–12	02	Sets the range over which you can control pitch by using the [PITCH BEND] wheel (page 50), in semitone increments.
009	Split Point	<i>SPlitPnt</i>	036–096 (C1–C6)	054 (F#2)	Refer to page 62.
010	Touch Response	<i>TouchRes</i>	1 (Soft), 2 (Medium), 3 (Hard), 4 (Fixed)	2 (Medium)	Refer to page 51.
011	Portamento	<i>Port.</i>	ON/OFF	OFF	Switches Portamento on or off.
012	Portamento Time	<i>PortTime</i>	000–127	064	Sets the Portamento Time.

Function Number	Function	Display	Range/Settings	Default Value	Description
Main Voice (page 19)					
013	Volume	<i>M. Volume</i>	000–127	*	Determines the volume of the Main Voice.
014	Octave	<i>M. Octave</i>	-2 – +2	*	Determines the octave range for the Main Voice.
015	Pan	<i>M. Pan</i>	L63–C–R63	*	Determines the stereo pan position of the Main Voice. A value of "L" results in the sound being panned full left, while a value of "R" results in the sound being panned full right.
016	Reverb Depth	<i>M. Reverb</i>	000–127	*	Determines how much of the Main Voice's signal is sent to the Reverb effect.
017	Chorus Depth	<i>M. Chorus</i>	000–127	*	Determines how much of the Main Voice's signal is sent to the Chorus effect.
018	Attack Time	<i>M. Attack</i>	000–127	064	Determines how fast the volume of the Main Voice reaches the Attack level when the note is pressed. The larger the value, the slower the attack rate. The smaller the value, the faster the attack rate.
019	Release Time	<i>M. Release</i>	000–127	064	Determines how fast the volume of the Main Voice falls to 0 when the note is released. The larger the value, the longer the sustain. The smaller the value, the shorter the sustain.
020	Filter Cutoff	<i>M. Cutoff</i>	000–127	064	Determines the Filter Cutoff Frequency (page 57) of the Main Voice.
021	Filter Resonance	<i>M. Reso.</i>	000–127	064	Determines the Filter Resonance (page 57) of the Main Voice.
Dual Voice (page 19)					
022	Dual Voice	<i>D. Voice</i>	001–801	*	Selects a Dual Voice.
023	Volume	<i>D. Volume</i>	000–127	*	Determines the volume of the Dual Voice.
024	Octave	<i>D. Octave</i>	-2 – +2	*	Determines the octave range for the Dual Voice.
025	Pan	<i>D. Pan</i>	L63–C–R63	*	Determines the stereo pan position of the Dual Voice. A value of "L" results in the sound being panned full left; a value of "R" results in the sound being panned full right.
026	Reverb Depth	<i>D. Reverb</i>	000–127	*	Determines how much of the Dual Voice's signal is sent to the Reverb effect.
027	Chorus Depth	<i>D. Chorus</i>	000–127	*	Determines how much of the Dual Voice's signal is sent to the Chorus effect.
028	Attack Time	<i>D. Attack</i>	000–127	064	Determines how fast the volume of the Dual Voice reaches the Attack level when the note is pressed. The larger the value, the slower the attack rate. The smaller the value, the faster the attack rate.
029	Release Time	<i>D. Release</i>	000–127	064	Determines how fast the volume of the Dual Voice falls to 0 when the note is released. The larger the value, the longer the sustain. The smaller the value, the shorter the sustain.
030	Filter Cutoff	<i>D. Cutoff</i>	000–127	064	Determines the Filter Cutoff Frequency (page 57) of the Dual Voice.
031	Filter Resonance	<i>D. Reso.</i>	000–127	064	Determines the Filter Resonance (page 57) of the Dual Voice.
Split Voice (page 20)					
032	Split Voice	<i>S. Voice</i>	001–801	094 (FngrBass)	Selects a Split Voice.
033	Volume	<i>S. Volume</i>	000–127	080	Determines the volume of the Split Voice.
034	Octave	<i>S. Octave</i>	-2 – +2	-1	Determines the octave range for the Split Voice.
035	Pan	<i>S. Pan</i>	L63–C–R63	064	Determines the stereo pan position of the Split Voice. A value of "L" results in the sound being panned full left; a value of "R" results in the sound being panned full right.
036	Reverb Depth	<i>S. Reverb</i>	000–127	008	Determines how much of the Split Voice's signal is sent to the Reverb effect.
037	Chorus Depth	<i>S. Chorus</i>	000–127	000	Determines how much of the Split Voice's signal is sent to the Chorus effect.

Function Number	Function	Display	Range/Settings	Default Value	Description
Effects					
038	Reverb Type	<i>Reverb</i>	01–13	**	Refer to page 49.
039	Chorus Type	<i>Chorus</i>	1–6	**	Refer to page 49.
040	Master EQ Type	<i>MasterEQ</i>	1 (Speaker), 2 (India), 3 (Headphone), 4 (Boost), 5 (Piano), 6 (Bright)	1 (Speaker)	Refer to page 52.
041	Melody Suppressor	<i>SUPPRPan</i>	L63–C–R63	C	Determines the pan position to be cancelled when the Melody Suppressor (page 46) is turned on.
DSP (page 23)					
042	DSP Type	<i>DSP Type</i>	01–10	01	Refer to page 23.
Knob (page 24)					
043	Target Change	<i>Target</i>	1 (Keyboard)– 2 (Backing)	Keyboard	Switches the Target controlled with the knobs.
Harmony/Arpeggio (page 21)					
044	Harmony Type/ Arpeggio Type	<i>Harm/Arp</i>	01–186	*	Determines the Harmony type or Arpeggio type.
045	Harmony Volume	<i>HarmVol</i>	000–127	*	Determines the volume of the Harmony effect.
046	Arpeggio Velocity	<i>ARP Velo</i>	1 (Original), 2 (Key)	Depends on the Arpeggio type	When "Key" is selected, the velocities of Arpeggio playback are determined by your playing strength. When "Original" is selected, the velocities of Arpeggio playback are determined by the original setting regardless of your playing strength.
047	Arpeggio Quantize	<i>Quantize</i>	1 (OFF), 2 (1/8), 3 (1/16)	Depends on the Arpeggio type	Refer to page 56.
Scale Tuning (page 53)					
048	Scale	<i>Scale</i>	1 (Equal), 2 (Pure Maj), 3 (Pure min), 4 (Bayat), 5 (Rast)	1 (Equal)	Refer to page 53.
049	Base Note	<i>BaseNote</i>	01 (C), 02 (C#), 03 (D), 04 (E ^b), 05 (E), 06 (F), 07 (F#), 08 (G), 09 (A ^b), 10 (A), 11 (B ^b), 12(B)	01 (C)	Refer to page 53.
050	Tuning Note	<i>TuneNote</i>	01 (C), 02 (C#), 03 (D), 04 (E ^b), 05 (E), 06 (F), 07 (F#), 08 (G), 09 (A ^b), 10 (A), 11 (B ^b), 12(B)	01 (C)	Refer to page 54.
051	Tuning	<i>Tune</i>	-64–63	Depends on the Scale	
MIDI					
052	Local Control	<i>Local</i>	ON/OFF	ON	Determines whether the instrument's keyboard controls the internal tone generator (ON) or not (OFF). When you record your keyboard performance to a computer app via MIDI, set this parameter to OFF.
053	External Clock	<i>ExtClock</i>	ON/OFF	OFF	Determines whether the instrument synchronizes to the internal clock (OFF) or an external clock (ON). When you record your keyboard performance to a computer app via MIDI, set this parameter to ON.
054	Keyboard Out	<i>KbdOut</i>	ON/OFF	ON	Determines whether MIDI messages generated via keyboard performance are transmitted (ON) or not (OFF) from the [USB TO HOST] terminal. When selecting Sampling Voice, it is not generated regardless of setting.
055	Style Out	<i>StyleOut</i>	ON/OFF	OFF	Determines whether MIDI messages generated via Style playback are transmitted (ON) or not (OFF) from the [USB TO HOST] terminal.

Function Number	Function	Display	Range/Settings	Default Value	Description
056	Song Out	<i>SongOut</i>	ON/OFF	OFF	Determines whether MIDI messages generated via Song playback are transmitted (ON) or not (OFF) from the [USB TO HOST] terminal.
057	Initial Send	<i>InitSend</i>	YES/NO	-	Allows you to send the data of the panel settings to a computer. Press [+ / YES] to send, or press [- / NO] to cancel. When recording a song to computer, perform this operation first before recording any notes, so that this instrument will be properly set during playback.
Audio (page 46)					
058	Audio Loopback	<i>LoopBack</i>	ON/OFF	ON	Determines whether Audio sound input from the [USB TO HOST] terminal is returned to the computer or not with the performance played on the instrument. If you want to output only the sound played on this instrument to the computer, set this parameter to OFF.
Sampling (page 33)					
059	Blank Cut	<i>BlankCut</i>	ON/OFF	ON	Determines whether the blank is cut automatically before and after Sample.
Metronome (page 20)					
060	Time Signature Numerator	<i>TimeSign</i>	00–60	**	Determines the time signature of the Metronome.
061	Time Signature Denominator	<i>TimeSigD</i>	Half note, Quarter note, Eighth note, Sixteenth note	**	Determines the length of each metronome beat.
062	Metronome Volume	<i>MtrVol</i>	000–127	100	Determines the volume of the Metronome.
Lesson (page 29)					
063	Lesson Track (R)	<i>R-Part</i>	GuideTrack1–16, OFF	1	Determines the guide track number for your right hand lesson. The setting is only effective for Songs in SMF format 0 transferred from a computer.
064	Lesson Track (L)	<i>L-Part</i>	GuideTrack1–16, OFF	2	Determines the guide track number for your left hand lesson. The setting is only effective for Songs in SMF format 0 transferred from a computer.
065	Your Tempo	<i>YourTemp</i>	ON/OFF	ON	This parameter is for Lesson 3 "Waiting." When set to ON, playback tempo will change to match the speed at which you are playing. When set to OFF, playback tempo will be maintained regardless of the speed at which you are playing.
Demo (page 27)					
066	Demo Group	<i>DemoGrp</i>	1 (Demo) / 2 (Preset) / 3 (User) / 4 (Download) / 5 (USB)	1 (Demo)	Refer to page 64.
067	Demo Play Mode	<i>PlayMode</i>	1 (Normal) / 2 (Random)	1 (Normal)	Refer to page 64.
068	Demo Cancel	<i>D-Cancel</i>	ON/OFF	OFF	Determines whether Demo cancel is enabled or not. When this is set to ON, the Demo Song will not play, even if the [DEMO/BGM] button is pressed.
Registration Memory (page 44)					
069	Style Freeze Mode	<i>StyleFrz</i>	ON/OFF	OFF	When set to on, the Style related settings are maintained even if you press another Registration Memory number button.
070	Transpose Freeze Mode	<i>TransFrz</i>	ON/OFF	OFF	When set to on, the Transpose settings are maintained even if you press another Registration Memory number button.
Auto Power Off (page 16)					
071	Auto Power Off Time	<i>AutoOfft</i>	OFF, 5/10/15/30/60/120 (min.)	30 minutes	Specifies the time that will elapse before the instrument's power is automatically turned off.
Battery (page 14)					
072	Battery Type	<i>Battery</i>	1 (Alkaline) / 2 (Ni-MH)	1 (Alkaline)	Selects the type of batteries you have installed to this instrument.

Function Number	Function	Display	Range/Settings	Default Value	Description
Pedal Function (page 56)					
073	Pedal Function	<i>Pd1 Func</i>	1 (Sustain) / 2 (Arp Hold) / 3 (Sus+ArpH) / 4 (Sostenut)	1 (Sustain)	Determines the function of the footswitch connected to the SUSTAIN jack (page 45). When "1 (Sustain)" or "4 (Sostenut)" is selected, the footswitch works as a damper pedal or sostenuto pedal as on an acoustic piano. Note that sustain does not affect the Split Voice, while sostenuto affects only the Split Voice when Split is on. When "2 (Arp Hold)" is selected, pressing the footswitch maintains Arpeggio playback even if you release the notes (page 56). When "3 (Sus+ArpH)" is selected, both the Arpeggio Hold and Sustain functions are assigned to the footswitch.

* The appropriate value is automatically set for each Voice.

** The appropriate value is automatically set for each Style, Song and Riyaz.

NOTE

- The MIDI and Audio settings are designed specifically for convenient use for when an external device such as a computer is connected to the [USB TO HOST] terminal (page 47).

USB Flash Drive Operations

By connecting a USB flash drive (sold separately) to the [USB TO DEVICE] terminal, you can save the data created on this instrument, such as User Song and parameter settings. The saved data can be recalled to this instrument again for future use.

IMPORTANT

- You should use an AC adaptor when executing USB flash drive operations, since battery power may not be reliable enough to last through these crucial operations. When you try executing certain functions, the "UseAdpt" indication may appear and the selected function cannot be executed.

Precautions when using the [USB TO DEVICE] terminal

This instrument features a built-in [USB TO DEVICE] terminal. When connecting a USB device to the terminal, be sure to handle the USB device with care. Follow the important precautions below.

NOTE

- For more information about the handling of USB devices, refer to the owner's manual of the USB device.

● Compatible USB devices

● USB flash drive

Other USB devices such as a USB hub, computer keyboard or mouse cannot be used.

The instrument does not necessarily support all commercially available USB devices. Yamaha cannot guarantee operation of USB devices that you purchase. Before purchasing a USB device for use with this instrument, please visit the following web page:

<https://download.yamaha.com/>

Although USB devices 1.1 to 3.0 can be used on this instrument, the amount of time for saving to or loading from the USB device may differ depending on the type of data or the status of the instrument.

NOTICE

- The rating of the [USB TO DEVICE] terminal is a maximum of 5V/500mA. Do not connect USB devices having a rating above this, since this can cause damage to the instrument itself.

● Connecting a USB device

When connecting a USB device to the [USB TO DEVICE] terminal, make sure that the connector on the device is appropriate and that it is connected in the proper direction.

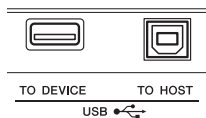

NOTICE

- Avoid connecting or disconnecting the USB device during playback/recording and file management operations (such as Save, Delete and Format), or when accessing the USB device. Failure to observe this may result in "freezing" of the operation of the instrument or corruption of the USB device and the data.
- When connecting then disconnecting the USB device (and vice versa), make sure to wait a few seconds between the two operations.
- Do not use an extension cable when connecting a USB device.

Using a USB Flash Drive

By connecting the instrument to a USB flash drive, you can save data you've created to the connected device, as well as read data from the connected device.

● Number of USB flash drives that can be used

Only one USB flash drive can be connected to the [USB TO DEVICE] terminal.

● Formatting a USB flash drive

You should format the USB flash drive only with this instrument (page 73). A USB flash drive formatted on another device may not operate properly.

NOTICE

- The format operation overwrites any previously existing data. Make sure that the USB flash drive you are formatting does not contain important data. Proceed with caution, especially when connecting multiple USB flash drive.

● To protect your data (write-protect)

To prevent important data from being inadvertently erased, apply the write-protect provided with each USB flash drive. If you are saving data to the USB flash drive, make sure to disable write-protect.

● Turning off the instrument

When turning off the instrument, make sure that the instrument is NOT accessing the USB flash drive by playback/recording or file management (such as during Save, Copy, Delete and Format operations). Failure to do so may corrupt the USB flash drive and the data.

Connecting a USB Flash Drive

NOTE

- Before using a USB flash drive, be sure to read "Precautions when using the [USB TO DEVICE] terminal" on page 71.
- Messages may appear on the display during File Control procedures to aid in operation. Refer to the Message List on page 78 for details.

1 Connect a USB flash drive to the [USB TO DEVICE] terminal, and wait until "USB" appears on the left corner of the display.

The "USB" indication confirms that the connected USB flash drive has been mounted or recognized.

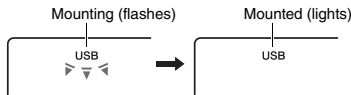

2 Hold down the [FUNCTION] button for longer than a second to call up the File Control display.

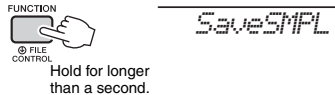

Hold for longer than a second.

● If "UnFormat" followed by "Format?" appears:

This indicates that the connected USB flash drive requires formatting. Execute the Format operation by following the instructions starting with step 2 on page 73.

NOTE

The File Control display cannot be called up in the following situations.

- During playback of Style, Riyaz, Song, Quick Sampling Mode, or Audio mode.
- When "USB" does not appear even if you have connected a USB flash drive to the [USB TO DEVICE] terminal.
- No sound will be produced if the keyboard is played while the File Control display is showing, and only buttons related to File Control operations will be active.

3 Use the CATEGORY [<<] and [>>] buttons to call up the desired File Control function, then execute it.

For details, refer to the table on the right.

File Control Display List

Display	File Control function	Page
SaveSMPL	Saving a Sample to a USB Flash Drive	35
LoadSMPL	Loading a Sample from a USB Flash Drive	36
Del SMPL	Deleting a Sample in a USB Flash Drive	36
DelAUDIO	Deleting an Audio Song in a USB Flash Drive	42
Save SMF	Saving a User Song as SMF to a USB Flash Drive	74
Del SMF	Deleting a SMF in a USB Flash Drive	77
Save USR	Saving a User Data to a USB Flash Drive	73
Load USR	Loading a User Data from a USB Flash Drive	75
Del USR	Deleting a User Data from a USB Flash Drive	77
Load STY	Loading a Style File	76
Format?	Formatting a USB Flash Drive	73
Exit?	Exiting from a File Control Display	78

NOTE

- You can also exit from a File Control display simply by pressing the [FUNCTION] button.

Valid file locations in the USB flash drive for Song playback (page 27)

IMPORTANT

- If you manage the Song files in the USB flash drive by using a computer, etc., make sure to store the data either in the USB flash drive's root directory or a first-level/second-level folder in the root directory. Data stored in third-level-folders created inside a second-level folder cannot be selected and played by this instrument.

USB flash drive (Root)

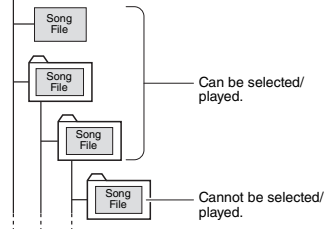

Formatting a USB Flash Drive

The Format operation lets you prepare commercially available USB flash drives for use with this instrument.

NOTICE

- The format operation overwrites any previously existing data. Make sure that the USB flash drive you are formatting does not contain important data.

1 Hold the [FUNCTION] button for longer than a second to call up the File Control display.

2 Use the CATEGORY [◀] and [▶] buttons to call up the “Format?” message.



3 Press the [0/EXECUTE] button.

A confirmation message will appear. To cancel the operation, press the [-/NO] button.

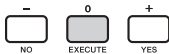

4 Press the [0/EXECUTE] button again or the [+ /YES] button to execute the Format operation.

After a while, a message indicating completion of the operation appears, and the “USER FILES” folder will be created in the USB flash drive.

NOTICE

- The Format operation cannot be cancelled during execution. Never turn off the power or disconnect the USB flash drive during the operation. Doing so may result in data loss.

5 Press the [FUNCTION] button to exit from the File Control display.

Saving User Data to a USB Flash Drive

User data is comprised of the following items.

- All 10 User Songs (page 37)
- Styles which have been transferred from a computer and then loaded to Style numbers 283–292 (page 76).
- All Registration Memory settings (page 43)

The User data can be saved as a single “User File” (.usr) to a USB flash drive.

NOTE

- For detail on saving Sample, refer to page 35.
- The extension (.usr) of the User File will not be shown on the display of this instrument. Confirm the extension on the computer display when connecting the USB flash drive to a computer.

1 Hold the [FUNCTION] button for longer than a second to call up the File Control display.

2 Use the CATEGORY [◀] and [▶] buttons to call up “Save USR.”



3 Press the [0/EXECUTE] button.

Target User file names appear on the display as “USER***” (***: number). If desired, rotate the dial to select a different file name from “USER001”–“USER100.”



4 Press the [0/EXECUTE] button again.

A confirmation message will appear. To cancel the operation, press the [-/NO] button.

Overwriting existing files

If a file that already contains data is selected as the target user file, “OverWr?” will appear on the display.

5 Press the [0/EXECUTE] button again, or the [+ /YES] button to execute the Save operation.

After a while, a message indicating completion of the operation appears, and a User file (.usr) will be saved in a "USER FILES" folder which will automatically be created on the USB flash drive.

NOTICE

- The Save operation cannot be cancelled during execution. Never turn off the power or disconnect the USB flash drive during the operation. Doing so may result in data loss.

NOTE

- The amount of time required for this operation may vary depending on the condition of the USB flash drive.

6 Press the [FUNCTION] button to exit from the File Control display.

NOTE

- If you want to recall the User file (.usr) to this instrument again, execute the Load operation (page 75).

Saving a User Song as SMF to a USB Flash Drive

A User Song can be converted to SMF (Standard MIDI File) format 0 and saved to a USB flash drive.

SMF (Standard MIDI File) format

With this format, various events via the keyboard performance such as note on/off and Voice selection will be recorded as MIDI data. The SMF Format 0 and Format 1 are available. A large number of MIDI devices are compatible with SMF Format 0, and most commercially available Song files (MIDI files) are provided in SMF Format 0.

NOTE

- If the size of a converted SMF is too large, it cannot be played back on this instrument. We recommend using Audio recording.
- The DSP effect (page 23) cannot be converted to SMF format.
- The Transpose setting on this instrument is not included in the data.

1 Hold the [FUNCTION] button for longer than a second to call up the File Control display.

2 Use the CATEGORY [<<] and [>>] buttons to call up "Save SMF."



3 Press the [0/EXECUTE] button.

Target User Song names appear on the display as "USER**" (**: number 1–10). If desired, rotate the dial to select a different User Song from "USER01"–"USER10" then press the [0/EXECUTE] button.



4 Press the [0/EXECUTE] button again.

Target file names on the USB flash drive appear on the display as "USER***" (***: number 1–100). If desired, rotate the dial to select the different file.



5 Press the [0/EXECUTE] button again.

A confirmation message will appear. To cancel the operation, press the [-/NO] button.

Overwriting existing files
If a file that already contains data is selected, an overwrite confirmation message will appear.

6 Press the [0/EXECUTE] button again, or the [+ /YES] button to execute the Save operation.

After a while, a message indicating completion of the operation appears, and a User Song will be saved (in SMF format 0) to a "USER FILES" folder, automatically created on the USB flash drive.

NOTICE

- The Save operation cannot be cancelled during execution. Never turn off the power or disconnect the USB flash drive during the operation. Doing so may result in data loss.

NOTE

- The amount of time required for this operation may vary depending on the condition of the USB flash drive.

7 Press the [FUNCTION] button to exit from the File Control display.

Loading User Data from a USB Flash Drive

A User data (page 73) saved as a User file (.usr) to the USB flash drive can be loaded to this instrument.

NOTICE

- Loading a User file will overwrite and erase the existing data, including all 10 User Songs, Style data loaded to the Style numbers 283–292, and all the Registration Memory settings. Save important data you want to keep to a separate USB flash drive before loading a User file.

IMPORTANT

- Note that User files should be saved in the "USER FILES" folder on the USB flash drive. Files saved outside this folder cannot be recognized.

NOTE

- About loading Sample, refer to page 36.

1 Hold the [FUNCTION] button for longer than a second to call up the File Control display.

2 Use the CATEGORY [<<] and [>>] buttons to call up "Load USR."



3 Press the [0/EXECUTE] button.

User file names on the USB flash drive appear on the display as "USER****" (****: number). As desired, rotate the dial to select a different User file.



4 Press the [0/EXECUTE] button again.

A confirmation message will appear. To cancel the operation, press the [-/NO] button.

5 Press the [0/EXECUTE] button again, or the [+ /YES] button to execute the Load operation.

After a while, a message indicating completion of the operation appears.

NOTICE

- The Load operation cannot be cancelled during execution. Never turn off the power or disconnect the USB flash drive during the operation. Doing so may result in data loss.

- 6 Press the [FUNCTION] button to exit from the File Control display.
- 7 Confirm that the data has been properly loaded by calling up the User Song, one of the Styles 283–292, and/or the Registration Memory settings.

Loading a Style File

Style data created on another instrument or a computer can be loaded to the Style numbers 283–292, and you can play them in the same way as the internal preset Styles. The following two Load operations are available.

- Loading of a Style file (.sty) saved on the root directory on the USB flash drive
- Loading of a Style file (.sty) transferred from a computer via the Musicsoft Downloader and stored in the internal memory of this instrument

NOTE

- For instructions on transferring a Style file from a computer via the Musicsoft Downloader, refer to the online PDF manual (page 11) “Computer-related Operations.” After data transfer, load the Style data to one of the Style numbers 283–292 to enable playback.

NOTICE

- Loading a Style file will overwrite and erase the existing data of the destination number. Save important data you want to keep to a separate USB flash drive before loading.

- 1 Hold the [FUNCTION] button for longer than a second to call up the File Control display.
- 2 Use the CATEGORY [<<] and [>>] buttons to call up the “Load STY” message.



- 3 Press the [0/EXECUTE] button. The name of a Style file in the USB flash drive or internal memory of this instrument will appear on

the display. If desired, rotate the dial to select a different Style file.

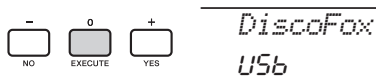

- 4 Press the [0/EXECUTE] button again. “Load To? ***” (***: 283–292) appears on the display as the Load destination. If desired, rotate the dial to select a different number.

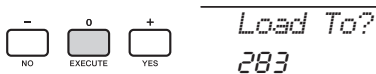

- 5 Press the [0/EXECUTE] button again. A confirmation message will appear. To cancel the operation, press the [-/NO] button.

- 6 Press the [0/EXECUTE] button again, or the [+ /YES] button to execute the Load operation.

After a while, a message indicating completion of the operation appears.

NOTICE

- The Load operation cannot be cancelled during execution. Never turn off the power or disconnect the USB flash drive during the operation. Doing so may result in data loss.

- 7 Press the [STYLE] button, rotate the dial to select a Style from 283–292, and then try playing it back.

Deleting a User File in the USB Flash Drive

User Files (.usr) in the root directory of the USB flash drive can be deleted.

IMPORTANT

- Only User files (.usr) saved in the “USER FILES” folder on the USB flash drive can be deleted. Files outside this folder cannot be recognized.

- 1 Hold the [FUNCTION] button for longer than a second to call up the File Control display.
- 2 Use the CATEGORY [<<] and [>>] buttons to call up the “Del USB” message.



- 3 Press the [0/EXECUTE] button. User file names in the USB flash drive appear on the display as “USER*****” (****, number). If desired, rotate the dial to select a different User file.

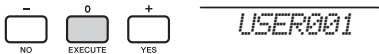

- 4 Press the [0/EXECUTE] button again. A confirmation message will appear. To cancel the operation, press the [-/NO] button.
- 5 Press the [0/EXECUTE] button again, or the [+ /YES] button to execute the Delete operation. After a while, a message indicating completion of the operation appears.

NOTICE

- The Delete operation cannot be cancelled during execution. Never turn off the power or disconnect the USB flash drive during the operation. Doing so may result in data loss.

- 6 Press the [FUNCTION] button to exit from the File Control display.

Deleting an SMF File in the USB Flash Drive

You can delete a SMF file that has been saved in the USB flash drive via the Save SMF operation (page 74).

IMPORTANT

- Only SMF files (.mid) saved in the “USER FILES” folder on the USB flash drive can be deleted. Files outside this folder cannot be recognized. This operation applies only to file names having the format “SONG*****” (****: 001–100).

- 1 Hold the [FUNCTION] button for longer than a second to call up the File Control display.
- 2 Use the CATEGORY [<<] and [>>] buttons to call up “Del SMF”:

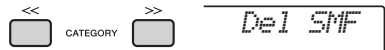

- 3 Press the [0/EXECUTE] button. SMF file names in the USB flash drive appear on the display as “SONG*****” (****, number). If desired, rotate the dial to select a different SMF file.

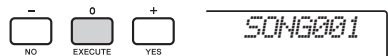

- 4 Press the [0/EXECUTE] button again. A confirmation message will appear. To cancel the operation, press the [-/NO] button.
- 5 Press the [0/EXECUTE] button again, or the [+ /YES] button to execute the Delete operation. After a while, a message indicating completion of the operation appears.

NOTICE

- The Delete operation cannot be cancelled during execution. Never turn off the power or disconnect the USB flash drive during the operation. Doing so may result in data loss.

- 6 Press the [FUNCTION] button to exit from the File Control display.

Exiting from a File Control Display

To exit from the File Control display, press the [FUNCTION], [VOICE], [STYLE], [SONG] or [RIYAZ] button.

You can also exit from the File Control function mode as follows:

- Use the CATEGORY [<<] and [>>] buttons to call up the “Exit?” message.

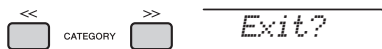

- Press the [0/EXECUTE] button to exit from the File Control display.

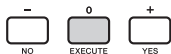

Message List

Message	Comment
Can'tUse	Indicates that the file control function is currently unavailable since the USB flash drive is being accessed.
Compleat.	Indicates completion of the corresponding operation, such as data saving or transmission.
Data Err	Displayed when the user song contains invalid data.
Disk Ful	Displayed when saving data cannot be executed since the memory has become full. Delete any unnecessary data or use another USB flash drive.
Error	Displayed when a file error or operational error occurs.
File Ful	Displayed when saving of data cannot be executed because the total number of files exceeds the capacity. Delete any unnecessary data or use another USB flash drive.
no data	There is no data in the memory.
no file	There is no file in the memory.
Ovr (Flashes)	Communication with the USB flash drive has been shut down because of overcurrent to the USB flash drive. Disconnect the USB flash drive from the [USB TO DEVICE] terminal, then turn on the power of the instrument.
Protect	Displayed when trying to save or delete data on a protected USB flash drive, or formatting a protected USB flash drive. Set protect to off and try again.
UnFormat	Displayed when connecting an unformatted USB flash drive.
UseAdpt	USB flash drive save, delete, and format operations cannot be performed when the instrument is being powered from battery. Use an AC adaptor.

Troubleshooting

Problem	Possible Cause and Solution
When the instrument is turned on or off, a popping sound is temporarily produced.	This is normal and indicates that the instrument is receiving electrical power.
When the instrument is turned on, power is turned off suddenly and unexpectedly.	This is normal. If an AC adaptor other than the one specified is used, power may be turned off suddenly and unexpectedly.
When using a mobile phone, noise is produced	Using a mobile phone in close proximity to the instrument may produce interference. To prevent this, turn off the mobile phone or use it further away from the instrument
The instrument is automatically turned off even if no operation is done.	This is normal. This occurs due to the Auto Power Off function (page 16).
<ul style="list-style-type: none"> •The volume is too soft. •The sound quality is poor. •The Style/Riyaz/Song/Arpeggio stops unexpectedly or will not play. •The recorded data of the song, etc. does not play correctly. •The LCD display suddenly goes dark, and all panel settings are reset. •The instrument turns off when a USB flash drive is connected. 	The batteries are low or dead. Replace all six batteries with completely new ones or completely recharged ones, or use the AC adaptor.
No sound is produced even when the keyboard is played, or a Song, Style, or Riyaz is being played back.	Check whether a set of headphones or an audio cable is connected to the [PHONES/OUTPUT], or not. When such a connection is made, no sound is output from the speaker of this instrument.
	Check the on/off status of the Local Control (page 68). Normally, set this parameter to ON.
The footswitch (for sustain) seems to produce the opposite effect. For example, pressing the footswitch cuts off the sound and releasing it sustains the sounds.	The polarity of the footswitch is reversed. Make sure that the footswitch plug is properly connected to the SUSTAIN jack before turning on the power.
Not all of the Voices seem to sound, or the sound seems to be cut off, when playing the keyboard, Arpeggio, Style or Song or Riyaz.	You have exceeded 48 simultaneous notes, which is the maximum polyphony (the maximum amount of notes that can be played simultaneously) of this instrument. If the Main, Dual, and Split Voices are being used along with playback of Arpeggio, Style, Riyaz or Song, some notes/sounds may be omitted (or "stolen").
The sound of the Voice changes from note to note.	This is normal. The tone generation method uses multiple recordings (samples) of an instrument across the range of the keyboard; thus, the actual sound of the Voice may be slightly different from note to note.
The keyboard performance and playback of Style/Song/Riyaz produces an unexpected or inappropriate sound, and cannot be restored to the normal status.	Using the Knobs can produce dramatic changes in the sound, but may also produce unexpected or undesired sounds. If you want to restore the original, normal sound before being changed by the Knobs, press the [DSP] button to turn DSP off, change the Voice, Style, Riyaz or Song, or press the [HARMONIUM/PIANO] button to reset the panel settings.
The Style, Song or Riyaz does not start even when the [START/STOP] button is pressed. The Arpeggio does not start even when the note is pressed with the Arpeggio turned on.	Check the on/off status of the External Clock (page 68). Normally, set this parameter to OFF.
The volume of the Style, Song or Riyaz is too low.	Check the volume setting in the Functions (pages 62 and 65).
The chords played in the left hand area cannot be recognized even when ACMP is turned on.	Check the Split Point setting (page 62). Set this to an appropriate value.
Style parts other than the Rhythm part produce no sound.	Check the on/off status of the ACMP (page 25). Make sure to turn ACMP on.
The ACMP indicator does not appear on the display when the [ACMP ON/OFF] button is pressed.	Check the on/off status of the [STYLE] lamp. When using a Style, press the [STYLE] button to turn on the [STYLE] lamp.

Refer to the "Message List" on pages 41, 78 as required.

Specifications

			PSR-I500
Product Name			Digital Keyboard
Size/Weight	Dimensions (W x D x H)		946 mm x 404 mm x 139 mm (37-1/4" x 15-7/8" x 5-1/2")
	Weight		6.6 kg (14 lbs., 9 oz.) (not including batteries)
Control Interface	Keyboard	Number of Keys	61
		Touch Response	Soft, Medium, Hard, Fixed
	Other Controllers	Pitch Bend Wheel	Yes
		Knobs	Yes
Panel	Language	English	
Voices	Tone Generation	Tone Generation Technology	AWM Stereo Sampling
	Polyphony (max.)		48
	Preset	Number of Voices	801 (257 Panel Voices + 32 Drum/Percussion/SFX Kits + 50 Arpeggio Voices + 462 XGlite Voices)
	Compatibility		GM, XGlite
Effects	Types	Reverb	12
		Chorus	5
		Master EQ	6
		DSP	10
	Functions	Dual	Yes
		Split	Yes
		Harmony	26
		Arpeggio	160
		Melody Suppressor	Yes
Accompaniment Styles	Preset	Number of Styles	282
		Fingering	Multi finger
		Style Control	ACMP ON/OFF, SYNC START, SYNC STOP, START/STOP, INTRO/ENDING/it., MAIN/AUTO FILL, TRACK ON/OFF
	External Styles		10
	Other Features	One Touch Setting (OTS)	Yes
	Compatibility		Style File Format (SFF)
Riyaz	Preset	Number of Riyaz Patterns	30
		Number of Sections	5
Songs (MIDI)	Preset	Number of Preset Songs	60
		Number of Songs	70
	Download	Number of Songs	10
		Number of Tracks	6 (5 Melody + 1 Style)
		Data Capacity	Approx. 19,000 notes (when only "melody" tracks are recorded)
	Format	Playback	SMF (Formats 0 & 1)
Recording		Original File Format (SMF 0 conversion function)	
USB Audio Recorder	Recording Time (max.)		80 minutes (approx. 0.9 GB) per Song
	Format	Playback	WAV(44.1 kHz, 16 bit, stereo)
Recording		WAV(44.1 kHz, 16 bit, stereo)	
Quick Sampling	Sampling Type		Normal, Oneshot, Loop
	Samples (Preset/User)		5
	Sampling Time		Approx. 9.6 sec.
	Sampling Sources		AUX IN
	Sampling Format		Original File Format (16 bit, stereo)
	Sampling Rate		44.1 kHz
Functions	USB audio interface		44.1 kHz, 16 bit, stereo
	Registration Memory	Number of Buttons	4 (x 8 banks)
		Metronome	Yes
	Overall Controls	Tempo Range	11 – 280
		Transpose	-12 to 0, 0 to +12
		Tuning	427.0 – 440.0 – 453.0 Hz (approx. 0.2Hz increments)
		Scale Type	5 types
	Miscellaneous	HARMONIUM/PIANO Button	
	Storage and Connectivity	Storage	Internal Memory
External Drives			USB flash drive
Connectivity		USB TO HOST, USB TO DEVICE, DC IN 12V, Headphones/Output, Sustain Pedal, AUX IN (Stereo-mini)	
Sound System	Amplifiers		6 W + 6 W
	Speakers		12 cm x 2

		PSR-I500
Power Supply	AC Adaptor	PA-150 or an equivalent recommended by Yamaha
	Batteries	Six "AA" size alkaline (LR6), manganese (R6) or Ni-MH rechargeable (HR6) batteries
	Power Consumption	8 W (When using PA-150 AC adaptor)
	Auto Power Off	Yes
Included Accessories		<ul style="list-style-type: none"> • Owner's Manual • AC adaptor* (PA-150 or an equivalent recommended by Yamaha) * May not be included depending on your area. Check with your Yamaha dealer. • Music Rest • Online Member Product Registration
Separately Sold Accessories (May not be available depending on your area.)		<ul style="list-style-type: none"> • AC adaptor: PA-150 or an equivalent recommended by Yamaha • Keyboard Stand: L-2C • Headphones: HPH-150/HPH-100/HPH-50 • Footswitch: FC4A/FC5 • Wireless MIDI adaptor: UD-BT01

*The contents of this manual apply to the latest specifications as of the publishing date. To obtain the latest manual, access the Yamaha website then download the manual file. Since specifications, equipment or separately sold accessories may not be the same in every locale, please check with your Yamaha dealer.

Index

- A**
- A-B Repeat 28
 - AC adaptor 14
 - Accessories 10
 - ACMP 25
 - Arpeggio 21, 56
 - Arpeggio Quantize 56
 - Arpeggio Type 22
 - Arpeggio Velocity 22
 - Attack 58
 - Audio Device 46
 - Audio Loopback 69
 - Auto Accompaniment 25
 - Auto Accompaniment area 25
 - Auto Power Off 16, 69
 - AUX IN 32, 46
- B**
- Background Music 64
 - Backup 48
 - Backup Clear 48
 - Base Note 53
 - Battery 14
 - Battery Type 15
 - Blank Cut 69
- C**
- Chord Type 63
 - Chorus 57
 - Chorus Type 49
 - Computer 47
 - Computer-related Operations .. 11
 - Connection 45
 - Cutoff 57
- D**
- Data List 11
 - Del SMF 72, 77
 - Del SMPL 36, 72
 - Del USR 72, 77
 - DelAUDIO 42, 72
 - Demo Song 27
 - Display 12, 18
 - DSP 23, 57
 - DSP Type 23
 - Dual Voice 19, 55
- E**
- ENDING 59
 - EQ (Equalizer) 52
 - External Clock 68
- F**
- Fast Forward 27
- Fast Reverse 27
- File Control display 72
- FILL 59
- Fine Tuning 50
- Flash Clear 48
- Footswitch 45, 56
- Formatting 71, 73
- Function 66
- H**
- Harmony 21
 - Harmony Type 22
 - Headphones 45
- I**
- Initial Send 69
 - Initialization 48
 - INTRO 59
 - iPhone/iPad Connection Manual ... 11
- K**
- Keyboard Out 68
 - Keyboard Stand 16
 - Knobs 24, 57
- L**
- Lesson 29
 - Lesson Track 69
 - Listen 29
 - Load STY 72, 76
 - Load USR 72, 75
 - LoadSMPL 36, 72
 - Local Control 68
 - Loop 32
- M**
- MAIN 59
 - Main Voice 19
 - Master EQ Type 52, 68
 - Master Volume 16
 - Melody Suppressor 46
 - Melody Voice 65
 - Message List 40, 41, 78
 - Metronome 20
 - MIDI 26
 - MIDI Basics 11
 - MIDI Reference 11
 - Music Rest 10
- N**
- Normal 32
- O**
- Octave 67
- One Touch Setting (OTS) ... 19, 51
- One-shot 32
- P**
- Pan 67
 - Pause 27
 - Pedal 45
 - Pitch 50
 - Pitch Bend Range 66
 - Portamento 50
 - Power 16
- Q**
- Quick Sampling 32
- R**
- RAGA SCALE 8, 26
 - Random 64
 - Recording 37, 40
 - Registration Memory 43
 - Release 57, 58
 - Repeat 28
 - Repeat & Learn 30
 - Resonance 57
 - Reverb 57
 - Reverb Type 49
 - Riyaz 31, 59, 61
- S**
- Sample Type 32
 - Sample Zone 32
 - Sampling 32
 - Save SMF 72, 74
 - Save USR 72, 73
 - SaveSMPL 35, 72
 - Scale 53
 - Sections 59
 - Smart Device 47
 - Song 26, 64
 - Song Book 11
 - Song Out 69
 - Sostenuto 45, 70
 - Specifications 80
 - Split Point 20, 62
 - Split Voice 20, 55
 - Stop Accompaniment 62
 - Style 25, 59
 - Style Out 68
 - Sustain 45
 - Synchro Stop 60
- T**
- Tabla 31, 57, 61
 - Tanpura 31, 57, 61
 - Tap Start 61, 65

Tempo.....	20, 61, 65
Time Signature	20
Timing.....	29
Touch Response.....	51
Track.....	28, 37, 38, 60
Transpose	50
Troubleshooting	79
Tuning.....	50, 54

U

USB Flash Drive	71
USB TO DEVICE.....	71
USB TO HOST	47

V

Voice.....	19, 55
Volume.....	16
Volume (AUX IN)	66
Volume (Harmony).....	22
Volume (Metronome).....	21
Volume (Song).....	65
Volume (Style)	62
Volume (USB TO DEVICE).....	66
Volume (USB TO HOST)	66
Volume (Voice)	67

W

Waiting.....	29
--------------	----

OBSERVERA!

Apparaten kopplas inte ur växelströmskällan (nätet) så länge som den är ansluten till vägguttaget, även om själva apparaten har stängts av.

ADVARSEL: Netspændingen til dette apparat er IKKE afbrudt, så længe netledningen sidder i en stikkontakt, som er tændt — også selvom der er slukket på apparatets afbryder.

VAROITUS: Laitteen toisiopiiriin kytketty käyttökytin ei irroita koko laitetta verkosta.

(standby)

Entsorgung leerer Batterien (nur innerhalb Deutschlands)

Leisten Sie einen Beitrag zum Umweltschutz. Verbrauchte Batterien oder Akkumulatoren dürfen nicht in den Hausmüll. Sie können bei einer Sammelstelle für Altbatterien bzw. Sondermüll abgegeben werden. Informieren Sie sich bei Ihrer Kommune.

(battery)

Information for users on collection and disposal of old equipment and used batteries:



These symbols on the products, packaging, and/or accompanying documents mean that used electrical and electronic products and batteries should not be mixed with general household waste. For proper treatment, recovery and recycling of old products and used batteries, please take them to applicable collection points, in accordance with your national legislation.



By disposing of these products and batteries correctly, you will help to save valuable resources and prevent any potential negative effects on human health and the environment which could otherwise arise from inappropriate waste handling.



For more information about collection and recycling of old products and batteries, please contact your local municipality, your waste disposal service or the point of sale where you purchased the items.

For business users in the European Union:

If you wish to discard electrical and electronic equipment, please contact your dealer or supplier for further information.



Information on Disposal in other Countries outside the European Union:

These symbols are only valid in the European Union. If you wish to discard these items, please contact your local authorities or dealer and ask for the correct method of disposal.



Note for the battery symbol (bottom two symbol examples):

This symbol might be used in combination with a chemical symbol. In this case it complies with the requirement set by the EU Battery Directive for the chemical involved.

Cd

(weee_battery_eu_en_02)



LIMITED 1-YEAR WARRANTY ON PORTABLE KEYBOARDS

(NP, PSRE, PSREW, PSRF, PSRI, SHS, EZ, DGX230, DGX530, YPG AND YPT SERIES)

Thank you for selecting a Yamaha product. Yamaha products are designed and manufactured to provide a high level of defect-free performance. Yamaha Corporation of America ("Yamaha") is proud of the experience and craftsmanship that goes into each and every Yamaha product. Yamaha sells its products through a network of reputable, specially authorized dealers and is pleased to offer you, the Original Owner, the following Limited Warranty, which applies only to products that have been (1) directly purchased from Yamaha's authorized dealers in the fifty states of the USA and District of Columbia (the "Warranted Area") and (2) used exclusively in the Warranted Area. Yamaha suggests that you read the Limited Warranty thoroughly and invites you to contact your authorized Yamaha dealer or Yamaha Customer Service if you have any questions.

Coverage: Yamaha will, at its option, repair or replace the product covered by this warranty if it becomes defective, malfunctions or otherwise fails to conform with this warranty under normal use and service during the term of this warranty, without charge for labor or materials. Repairs may be performed using new or refurbished parts that meet or exceed Yamaha specifications for new parts. If Yamaha elects to replace the product, the replacement may be a reconditioned unit. You will be responsible for any installation or removal charges and for any initial shipping charges if the product(s) must be shipped for warranty service. However, Yamaha will pay the return shipping charges to any destination within the USA if the repairs are covered by the warranty. This warranty does not cover (a) damage, deterioration or malfunction resulting from accident, negligence, misuse, abuse, improper installation or operation or failure to follow instructions according to the Owner's Manual for this product; any shipment of the product (claims must be presented to the carrier); repair or attempted repair by anyone other than Yamaha or an authorized Yamaha Service Center; (b) any unit which has been altered or on which the serial number has been defaced, modified or removed; (c) normal wear and any periodic maintenance; (d) deterioration due to perspiration, corrosive atmosphere or other external causes such as extremes in temperature or humidity; (e) damages attributable to power line surge or related electrical abnormalities, lightning damage or acts of God; or (f) RFI/EMI (Interference/noise) caused by improper grounding or the improper use of either certified or uncertified equipment, if applicable. Any evidence of alteration, erasing or forgery of proof-of-purchase documents will cause this warranty to be void. This warranty covers only the Original Owner and is not transferable.

In Order to Obtain Warranty Service: Warranty service will only be provided for defective products within the Warranted Area. Contact your local authorized Yamaha dealer who will advise you of the procedures to be followed. If this is not successful, contact Yamaha at the address, telephone number or website shown below. Yamaha may request that you send the defective product to a local authorized Yamaha Servicer or authorize return of the defective product to Yamaha for repair. If you are uncertain as to whether a dealer has been authorized by Yamaha, please contact Yamaha's Service Department at the number shown below, or check Yamaha's website at www.Yamaha.com. Product(s) shipped for service should be packed securely and must be accompanied by a detailed explanation of the problem(s) requiring service, together with the original or a machine reproduction of the bill of sale or other dated, proof-of-purchase document describing the product, as evidence of warranty coverage. Should any product submitted for warranty service be found ineligible therefore, an estimate of repair cost will be furnished and the repair will be accomplished only if requested by you and upon receipt of payment or acceptable arrangement for payment.

Limitation of Implied Warranties and Exclusion of Damages: ANY IMPLIED WARRANTIES, INCLUDING WARRANTIES OF MERCHANTABILITY AND FITNESS FOR A PARTICULAR PURPOSE SHALL BE LIMITED IN DURATION TO THE APPLICABLE PERIOD OF TIME SET FORTH ABOVE. YAMAHA SHALL NOT BE RESPONSIBLE FOR INCIDENTAL OR CONSEQUENTIAL DAMAGES OR FOR DAMAGES BASED UPON INCONVENIENCE, LOSS OF USE, DAMAGE TO ANY OTHER EQUIPMENT OR OTHER ITEMS AT THE SITE OF USE OR INTERRUPTION OF PERFORMANCES OR ANY CONSEQUENCES. YAMAHA'S LIABILITY FOR ANY DEFECTIVE PRODUCT IS LIMITED TO REPAIR OR REPLACEMENT OF THE PRODUCT, AT YAMAHA'S OPTION. SOME STATES DO NOT ALLOW LIMITATIONS ON HOW LONG AN IMPLIED WARRANTY LASTS OR THE EXCLUSION OR LIMITATION OF INCIDENTAL OR CONSEQUENTIAL DAMAGES, SO THE ABOVE LIMITATION OR EXCLUSION MAY NOT APPLY TO YOU. This Warranty gives you specific legal rights, and you may also have other rights which vary from state to state. This is the only express warranty applicable to the product specified herein; Yamaha neither assumes nor authorizes anyone to assume for it any other express warranty.

If you have any questions about service received or if you need assistance in locating an authorized Yamaha Servicer, please contact:



CUSTOMER SERVICE

Yamaha Corporation of America

6600 Orangethorpe Avenue, Buena Park, California 90620-1373

Telephone: 800-854-1569

www.yamaha.com

Do not return any product to the above address without a written Return Authorization issued by YAMAHA.

© 2018 Yamaha Corporation of America.

Important Notice: Guarantee Information for customers in Europe, Economic Area (EEA) and Switzerland

Important Notice: Guarantee Information for customers in EEA* and Switzerland For detailed guarantee information about this Yamaha product, and Pan-EEA* and Switzerland warranty service, please either visit the website address below (Printable file is available at our website) or contact the Yamaha representative office for your country. * EEA: European Economic Area	English
Wichtiger Hinweis: Garantie-Information für Kunden in der EMW*, und der Schweiz Für wichtige Garantie-Information über dieses Produkt von Yamaha, sowie über den Pan-EMW* und Schweizer Garantieservice, besuchen Sie bitte entweder die folgende angegebene Internetadresse (eine druckfähige Version befindet sich auch auf unserer Webseite), oder wenden Sie sich an den für Ihr Land zuständigen Yamaha-Vertrieb. *EMW: Europäischer Wirtschaftsraum	Deutsch
Remarque importante: informations de garantie pour les clients de l'EEE et la Suisse Pour des informations plus détaillées sur la garantie de ce produit Yamaha et sur le service de garantie applicable dans l'ensemble de l'EEE ainsi qu'en Suisse, consultez notre site Web à l'adresse ci-dessous (le fichier imprimable est disponible sur notre site Web) ou contactez directement Yamaha dans votre pays de résidence. * EEE : Espace Economique Européen	Français
Belangrijke mededeling: garantie-informatie voor klanten in de EER* en Zwitserland Voor gedetailleerde garantie-informatie over dit Yamaha-product en de garantieservice in heel de EER* en Zwitserland, gaat u naar de onderstaande website (u vindt een afdrukbare versie op onze website) of neemt u contact op met de vertegenwoordiging van Yamaha in uw land. * EER: Europese Economische Ruimte	Nederlands
Aviso importante: información sobre la garantía para los clientes del EEE* y Suiza Para una información detallada sobre este producto Yamaha y sobre el soporte de garantía en la zona EEE* y Suiza, visite la página web que aparece a continuación (también está disponible en nuestro sitio web) o póngase en contacto con el representante de Yamaha en su país. * EEE: Espacio Económico Europeo	Español
Aviso importante: informazioni sulla garanzia per i clienti residenti nell'EEA* e in Svizzera Per informazioni dettagliate sulla garanzia relativa a questo prodotto Yamaha e l'assistenza in garanzia nei paesi EEA* e in Svizzera, potete consultare il sito Web all'indirizzo riportato di seguito (è disponibile il file in formato stampabile) oppure contattare l'ufficio di rappresentanza locale della Yamaha. * EEA: Area Economica Europea	italiano
Aviso importante: informações sobre as garantias para clientes da AEE* e da Suíça Para obter uma informação pormenorizada sobre este produto da Yamaha e sobre o serviço de garantia na AEE* e na Suíça, visite o site a seguir (o arquivo para impressão está disponível no nosso site) ou entre em contato com o escritório de representação da Yamaha no seu país. * AEE: Área Econômica Europeia	Português
Значливиј информациони: Гарантиски информации за нашите клиенти од EEO* и Швајцарија За детални информации за оваа гаранција и сервисот за гаранција за овој Yamaha-производ, посетете ја нашата веб-страница (печатлива верзија е достапна на нашата веб-страница) или контактирајте со нашиот локален представител во вашето земјо. * EEO: Европски Економски Простор	Македонски
Viktig informasjon for kunder i EES-området* och Sveits För detaljerad information om denna Yamaha-produkt samt garantiservice i hela EES-området* och Sveits kan du antingen besöka nedanstående webbadress (en utskriftsvänlig fil finns på webbplatsen) eller kontakta Yamahas officiella representant i ditt land. * EES: Europeiska Ekonomiska Samarbetsområdet	Svenska
Viktig merknad: Garantinformasjon for kunder i EES* og Sveits De kan finne detaljerte garantinformasjon om dette Yamaha-produktet og garantitjeneste for hele EES-området* og Sveits kan fås enten ved å besøke nettstedene nedenfor (utskriftsvennlige filer finnes på nettstedene) eller kontakte Yamahas kontoret i landet der du bor. *EES: Det europeiske økonomiske samarbeidsområdet	Norsk
Vigtig oplysning: Garantiplysninger til kunder i EEO* og Schweiz De kan finde detaljerede garantiplysninger om dette Yamaha-produkt og dets garantitjeneste i hele EEO-området* og Schweiz ved at besøge de nævnte adresser (der findes en til dem kan udskrives, på vores website), eller ved at kontakte Yamahas nationale repræsentationskontor i det land, hvor De bor. * EEO: Det Europæiske Økonomiske Samarbejdsområde	Dansk

Tärkeä ilmoitus: Taku tiedot Euroopan talousalueen (ETA*) ja Sveitsin asiakkaille Tämän Yamaha-tuotteen sekä ETA-tuotteen ja Sveitsin takuista koskevat yksityiskohtaiset tiedot saatte alla olevasta nettiosoitteesta. (Tulostettava tiedosto saatavissa sivustollamme.) Voitte myös ottaa yhteyttä paikalliseen Yamahan edustajaan. *ETA: Euroopan talousalue	Suomi
Ważne: Warunki gwarancji i obowiązujące w EEO* i Szwajcarii Aby dowiedzieć się więcej o warunkach gwarancyjnych tego produktu firmy Yamaha i serwisu gwarancyjnym w całym EEO* i Szwajcarii, należy odwiedzić adres strony internetowej (plik do pobrania znajduje się na naszej stronie internetowej) lub skontaktować się z przedstawicielstwem firmy Yamaha w swoim kraju. * EEO — Europejski Obszar Gospodarczy	Polski
Důležitá oznámení: Záruční informace pro zákazníky v EHS* a ve Švýcarsku Podrobné záruční informace o tomto produktu Yamaha a záručním servisu v celém EHS* a ve Švýcarsku naleznete na níže uvedené webové adrese (soubor k tisku je dostupný na našich webových stránkách) nebo se můžete obrátit na zástupce firmy Yamaha ve své zemi. * EHS: Evropský hospodářský prostor	Česky
Fontos figyelemzvetés: Garancia-információk az EGT* területén és Svájcban élő vásárlók számára A jelen Yamaha termékre vonatkozó részletes garancia-információk, valamint az EGT*-es és Svájcra kiterjedő garanciális szolgáltatás technikai részletei keresse fel webhelyünkön az alábbi címen (a webhelyen nyomtatható fájllal is találja), vagy pedig lépjen kapcsolatba az országában működő Yamaha képviselőjével. * EGT: Európai Gazdasági Térség	Magyar
Ödulline märkus: Garantiteave Euroopa Majanduspiirkonna (EMP) ja Šveitsi klientidele Täpsemat teabe saamiseks sellel Yamaha toote garantii ning Euroopa Majanduspiirkonnaja Šveitsi garantiteeninduse kohta, küsige meie veebilehel või saadaval printida faili või pöörduge teie riigis Yamaha esinduse poole. * EMP: Euroopa Majanduspiirkond	Eesti keel
Svarstus paziņojums: garantijas informācija klientiem EEZ* un Šveicā Lai saņemtu detaļāku garantijas informāciju par šo Yamaha produktu, kā arī garantijas apkalpošanu EEZ* un Šveicā, lūdzam apmeklētjiet zīmāk norādīto tīmekļa vietnes adresi (tīmekļa vietnē ir pieejams drukājams fails) vai sazināties ar jūsu valstī apkalpošo Yamaha pārstāvētību. * EEZ: Eiropas Ekonomikas zona	Latviešu
Dāmesis: informācija dēl garantijas pirkšanas EEE* ir Šveicarijā Jei reikais šāsmoms informācijas apie šo „Yamaha” produktu ir jo tehniskn priēziūru visoe EEE* ir Šveicarijā, apakānkytite mūsā svārtēnē tolu nurodytu adresā (Ievēlānē jā ra spāudināms fails) abā kreipbties i „Yamaha” atbavēbē savā šālā. *EEE – Eiropas ekonomiskā atvā	Lietuvī kalba
Dôležitá upozornenie: Informácie o záruke pre zákazníkov v EHP* a Švajčiarsku Podrobné informácie o záruke týkajúcej sa tohto produktu od spoločnosti Yamaha a garancijnom servise v EHP* a Švajčiarsku nájdete na našej webovej stránke (k dispozícii súbor na ťažobu alebo sa obrátite na zástupcu spoločnosti Yamaha vo svojom regióne). * EHP: Európsky hospodársky priestor	Slovenčina
Pomembno obavestilo: Informacije o garanciji za kupce v EEP* in Švici Za podrobnejše informacije o tem Yamahinem izdelku ter garancijskem servisu v celotnem EEP in Švici, obiščite našo spletno mesto, ki je navedeno spodaj (našljajljiva datoteka je na voljo na našem spletnem mestu), ali se obrnite na Yamahinega predstavnika v svoji državi. * EEP: Evropski gospodarski prostor	Slovenščina
Важно съобщение: Информация за гаранцията за клиентите в ЕИП* и Швейцария За подробна информация за гаранцията за този продукт на Yamaha и гаранционното обслужване в палеоевропейската зона на ЕИП* и Швейцария или посетете посочения уеб сайт (на нашия уеб сайт има файл за печат), или се свържете с представителния офис на Yamaha във вашата страна. * ЕИП: Европейско икономическо пространство	Български език
Notificare importantă: Informații despre garanție pentru clienții din SEE* și Elveția Pentru informații detaliate privind acest produs Yamaha și serviciul de garanție Pan-SEE* și Elveția, vizitați site-ul la adresa de mai jos (fișierul imprimabil este disponibil pe site-ul nostru) sau contactați biroul reprezentanții Yamaha din țara dumneavoastră. * SEE: Spațiul Economic European	Limba română

<http://europe.yamaha.com/warranty/>

For details of products, please contact your nearest Yamaha representative or the authorized distributor listed below.

NORTH AMERICA

CANADA

Yamaha Canada Music Ltd.
135 Milner Avenue, Toronto, Ontario M1S 3R1,
Canada
Tel: +1-416-298-1311

U.S.A.

Yamaha Corporation of America
6600 Orangefhorpe Avenue, Buena Park, CA 90620,
U.S.A.
Tel: +1-714-522-9011

CENTRAL & SOUTH AMERICA

MEXICO

Yamaha de México, S.A. de C.V.
Av. Insurgentes Sur 1647 Piso 9, Col. San José
Insurgentes, Delegación Benito Juárez, México,
D.F., C.P. 03900, México
Tel: +52-55-5804-0600

BRAZIL

Yamaha Musical do Brasil Ltda.
Rua Fidêncio Ramos, 302 – Cj 52 e 54 – Torre B –
Vila Olímpia – CEP 04551-010 – São Paulo/SP,
Brazil
Tel: +55-11-3704-1377

ARGENTINA

**Yamaha Music Latin America, S.A.,
Sucursal Argentina**
Olga Cossettini 1553, Piso 4 Norte,
Madero Este-C1107CEK,
Buenos Aires, Argentina
Tel: +54-11-4119-7000

PANAMA AND OTHER LATIN

AMERICAN COUNTRIES/ CARIBBEAN COUNTRIES

Yamaha Music Latin America, S.A.
Edificio Torre Davivienda, Piso: 20
Avenida Balboa, Marbella, Corregimiento de Bella
Vista, Ciudad de Panamá, Rep. de Panamá
Tel: +507-269-5311

EUROPE

THE UNITED KINGDOM/IRELAND

Yamaha Music Europe GmbH (UK)
Sherbourne Drive, Tilbrook, Milton Keynes,
MK7 8BL, U.K.
Tel: +44-1908-366700

GERMANY

Yamaha Music Europe GmbH
Siemensstrasse 22-34, 25462 Rellingen, Germany
Tel: +49-4101-303-0

SWITZERLAND/LIECHTENSTEIN

**Yamaha Music Europe GmbH, Branch
Switzerland in Thalwil**
Seestrasse 18a, 8800 Thalwil, Switzerland
Tel: +41-44-3878800

AUSTRIA/CROATIA/CZECH REPUBLIC/ HUNGARY/ROMANIA/SLOVAKIA/ SLOVENIA

Yamaha Music Europe GmbH, Branch Austria
Schlegelgasse 20, 1100 Wien, Austria
Tel: +43-1-60203900

POLAND

Yamaha Music Europe GmbH
Sp.z o.o. Oddział w Polsce
ul. Wielicka 52, 02-657 Warszawa, Poland
Tel: +48-22-880-08-88

BULGARIA

Dinacord Bulgaria LTD.
Bul. Iskarsko Schose 7 Targoviszi Zentar Ewropa
1528 Sofia, Bulgaria
Tel: +359-2-978-20-25

MALTA

Olimpus Music Ltd.
Valletta Road, Mosta MST9010, Malta
Tel: +356-2133-2093

NETHERLANDS/BELGIUM/ LUXEMBOURG

Yamaha Music Europe, Branch Benelux
Clarissenhof 5b, 4133 AB Vianen, The Netherlands
Tel: +31-347-3578040

FRANCE

Yamaha Music Europe
7 rue Ambroise Croizat, Zone d'activités de Pariest,
77183 Croissy-Beaubourg, France
Tel: +33-1-6461-4000

ITALY

Yamaha Music Europe GmbH, Branch Italy
Via Tinelli N.67/69 20855 Gernò di Lesmo (MB),
Italy
Tel: +39-039-9065-1

SPAIN/PORTUGAL

**Yamaha Music Europe GmbH Ibérica, Sucursal
en España**
Ctra. de la Coruña km. 17,200, 28231
Las Rozas de Madrid, Spain
Tel: +34-91-639-88-88

GREECE

Philippos Nakas S.A. The Music House
19th km. Leof. Lavriou 190 02 Peania – Attiki,
Greece
Tel: +30-210-6686260

SWEDEN

**Yamaha Music Europe GmbH Germany filial
Scandinavia**
JA Wettergrensgata 1, 400 43 Göteborg, Sweden
Tel: +46-31-89-34-00

DENMARK

**Yamaha Music Denmark,
Filial of Yamaha Music Europe GmbH, Tyskland**
Generatorvej 8C, ST. TH., 2860 Soborg, Denmark
Tel: +45-44-92-49-00

FINLAND

F-Musikki Oy
Antakentie 4
FI-01510 Vantaa, Finland
Tel: +358 (0)96185111

NORWAY

**Yamaha Music Europe GmbH Germany -
Norwegian Branch**
Grini Næringspark 1, 1332 Østerås, Norway
Tel: +47-6716-7800

ICELAND

Hljóðfaerhusid Ehf.
Sidumula 20
IS-108 Reykjavik, Iceland
Tel: +354-525-5050

CYPRUS

Nakas Music Cyprus Ltd.
Nikis Ave 2k
1086 Nicosia
Tel: +357-22-511080
Major Music Center
21 Ali Riza Ave. Ortakoy
P.O.Box 475 Lefkoşa, Cyprus
Tel: (392) 227 9213

RUSSIA

Yamaha Music (Russia) LLC.
Room 37, entrance 7, bld. 7, Kievskaya street,
Moscow, 121059, Russia
Tel: +7-495-626-5005

OTHER EUROPEAN COUNTRIES

Yamaha Music Europe GmbH
Siemensstrasse 22-34, 25462 Rellingen, Germany
Tel: +49-4101-303-0

AFRICA

Yamaha Music Gulf FZE
JAFZA-16, Office 512, P.O.Box 17328,
Jebel Ali FZE, Dubai, UAE
Tel: +971-4-801-1500

MIDDLE EAST

TURKEY

Yamaha Music Europe GmbH
Merkezi Almanyay Türkiye Istanbul Subesi
Mor Sumbul Sokak Varyap Meridian Business
1.Blok No:111-114-115
Bati Atasehir Istanbul, Turkey
Tel: +90-216-275-7960

ISRAEL

RBX International Co., Ltd.
P.O.Box 10245, Petach-Tikva, 49002
Tel: (972) 3-925-6900

OTHER COUNTRIES

Yamaha Music Gulf FZE
JAFZA-16, Office 512, P.O.Box 17328,
Jebel Ali FZE, Dubai, UAE
Tel: +971-4-801-1500

ASIA

THE PEOPLE'S REPUBLIC OF CHINA

Yamaha Music & Electronics (China) Co., Ltd.
2F, Yunhedasha, 1818 Xinzha-lu, Jingan-qu,
Shanghai, China
Tel: +86-400-051-7700

HONG KONG

Tom Lee Music Co., Ltd.
11/F, Silvercort Tower 1, 30 Canton Road,
Tsimshatsui, Kowloon, Hong Kong
Tel: +852-2737-7688

INDIA

Yamaha Music India Private Limited
P-401, JMD Megapolis, Sector-48, Sohna Road,
Gurgaon-120118, Haryana, India
Tel: +91-124-485-3300

INDONESIA

PT. Yamaha Musik Indonesia (Distributor)
Yamaha Music Center Bldg. Jalan Jend. Gatot
Subroto Kav. 4, Jakarta 12930, Indonesia
Tel: +62-21-520-2577

KOREA

Yamaha Music Korea Ltd.
11F, Prudential Tower, 298, Gangnam-daero,
Gangnam-gu, Seoul, 06253, Korea
Tel: +82-2-3467-3300

MALAYSIA

Yamaha Music (Malaysia) Sdn. Bhd.
No.8, Jalan Perbandaran, Kelana Jaya, 47301
Petaling Jaya, Selangor, Malaysia
Tel: +60-3-78030900

SINGAPORE

Yamaha Music (Asia) Private Limited
Block 202 Hougang Street 21, #02-00,
Singapore 530202, Singapore
Tel: +65-6740-9200

TAIWAN

Yamaha Music & Electronics Taiwan Co., Ltd.
2F, No.1, Yuandong Rd., Banqiao Dist.,
New Taipei City 22063, Taiwan (R.O.C.)
Tel: +886-2-7741-8888

THAILAND

Siam Music Yamaha Co., Ltd.
3, 4, 15, 16th Fl., Siam Motors Building,
891/1 Rama 1 Road, Wangmai,
Pathumwan, Bangkok 10330, Thailand
Tel: +66-2215-2622

VIETNAM

Yamaha Music Vietnam Company Limited
15th Floor, Nam A Bank Tower, 201-203 Cach
Mang Thang Tam St., Ward 4, Dist.3,
Ho Chi Minh City, Vietnam
Tel: +84-28-3818-1122

OTHER ASIAN COUNTRIES

[https://asia-latinamerica-mea.yamaha.com/
index.html](https://asia-latinamerica-mea.yamaha.com/index.html)

OCEANIA

AUSTRALIA

Yamaha Music Australia Pty. Ltd.
Level 1, 80 Market Street, South Melbourne,
VIC 3205 Australia
Tel: +61-3-9693-5111

NEW ZEALAND

Music Works LTD
P.O.Box 6246 Wellesley, Auckland 4680,
New Zealand
Tel: +64-9-634-0099

COUNTRIES AND TRUST TERRITORIES IN PACIFIC OCEAN

[https://asia-latinamerica-mea.yamaha.com/
index.html](https://asia-latinamerica-mea.yamaha.com/index.html)

Yamaha Global Site
<https://www.yamaha.com/>

Yamaha Downloads
<https://download.yamaha.com/>

Manual Development Group
© 2019 Yamaha Corporation

Published 4/2019 POIN*.*-**A1

VAW4430