



# CS2x

CONTROL  
SYNTHESIZER

- Neat Knobs & other realtime controls
- Vivacious voices
- 3 excellent DSP effect sections
- Powerful desktop music options
- Piercing arpeggios, plus much more from this dauntless DJ device



OWNER'S MANUAL

# FORMANT SHAPING / FM SYNTHESIS TONE GENERATOR



# FS1R

## Formant Shaping Synthesis: The Evolution of FM



- **New synthesis technology — FS Synthesis (Formant shaping / FM synthesis) — creates sound with characteristics and flexibility similar to the human voice for extraordinary sonic depth and expressive control.**
- **Upward compatible with voices from the “classic” FM synthesizers and tone generators, such as the Yamaha DX and TX series.**
- **Formant Sequences — “Fseqs” — produce other-worldly vocal phrases, rhythm loops, and more.**
- **Assignable control knobs for extended real-time sonic control as well as easy programming.**
- **A huge selection of 1408 preset voices, including the best from the original DX and TX series.**

### Block Diagram

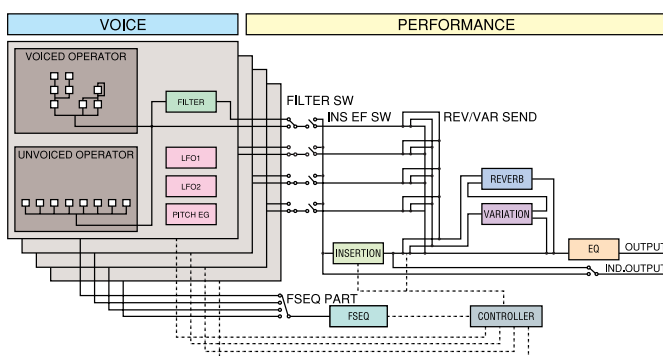

### Specifications

<b>Tone Generation System</b>	Tone Generators Multi-Timbres Polyphony	Formant Shaping / FM Synthesis 4 Parts (16 MIDI Channel Multi-Timbre) 32 notes (DVA)
<b>DEMO Songs</b>	15	
<b>Number of Voices</b>	<b>Performance</b> Preset 384 (128 x 3 banks), Internal 128	<b>Voice</b> Preset 1408 (128 x 11 banks), Internal 128 / 64 (Internal Fseq)
	<b>Fseq (Formant Sequence)</b> Preset 90, Internal 6 (max)	
<b>Components</b>	<b>Performance</b> 4 Parts (4 Voices), Fseq (Formant Sequence), Voice Controller (Source / Destination Assignable Matrix) Effects Reverb 16 types, Variation 28 types, Insertion 40 types, Equalizer	
	<b>Voice</b> 16 Operators (Voiced x 8, Unvoiced x 8), 88 Algorithms, LFO1, LFO2, Dynamic Filter, Pitch EG	
<b>Controls</b>	POWER Switch Main Volume x 1 Sound Control Knob x 4 (Absolute / Relative) Mode x 6 (PLAY, EDIT [PERFORM], EDIT [EFFECT], EDIT [VOICE], UTIL, SEARCH) Data x 9 (MUTE/SOLO, ENTER, EXIT, PART, CURSOR, VALUE) Knob Select x 2 (ATTACK, RELEASE, FORMANT, FM / KN1-4)	
<b>Display</b>	LCD (Backlit) LED Mode x 6 Green, Knob Select x 2 Red	
<b>Terminals</b>	Front panel Rear panel	Phones Output L(MONO), R Individual Out L, R MIDI IN/OUT/THRU
<b>Dimensions</b>	480(W) x 235(D) x 44(H) mm	
<b>Weight</b>	2.6Kg	
<b>Power Consumption</b>	USA 120V (60Hz) Europe 240V (50Hz)	12.0 Watts 12.0 Watts
<b>Included Accessories</b>	Owner's Manual x 1, Data List x 1, AC Power Cord x 1	

Descriptions and photographs in this brochure are for information purposes only, and specifications are subject to change without notice.

# SPECIAL MESSAGE SECTION

This product utilizes batteries or an external power supply (adapter). DO NOT connect this product to any power supply or adapter other than one described in the manual, on the name plate, or specifically recommended by Yamaha.

## **WARNING:**

Do not place this product in a position where anyone could walk on, trip over, or roll anything over power or connecting cords of any kind. The use of an extension cord is not recommended! IF you must use an extension cord, the minimum wire size for a 25' cord (or less) is 18 AWG. NOTE: The smaller the AWG number, the larger the current handling capacity. For longer extension cords, consult a local electrician.

This product should be used only with the components supplied or; a cart, rack, or stand that is recommended by Yamaha. If a cart, etc., is used, please observe all safety markings and instructions that accompany the accessory product.

## **SPECIFICATIONS SUBJECT TO CHANGE:**

The information contained in this manual is believed to be correct at the time of printing. However, Yamaha reserves the right to change or modify any of the specifications without notice or obligation to update existing units.

This product, either alone or in combination with an amplifier and headphones or speaker/s, may be capable of producing sound levels that could cause permanent hearing loss. DO NOT operate for long periods of time at a high volume level or at a level that is uncomfortable. If you experience any hearing loss or ringing in the ears, you should consult an audiologist.

**IMPORTANT:** The louder the sound, the shorter the time period before damage occurs.

Some Yamaha products may have benches and / or accessory mounting fixtures that are either supplied with the product or as optional accessories. Some of these items are designed to be dealer assembled or installed. Please make sure that benches are stable and any optional fixtures (where applicable) are well secured BEFORE using. Benches supplied by Yamaha are designed for seating only. No other uses are recommended.

## **NOTICE:**

Service charges incurred due to a lack of knowledge relating to how a function or effect works (when the unit is operating as designed) are not covered by the manufacturer's warranty, and are therefore the owners responsibility. Please study this manual carefully and consult your dealer before requesting service.

## **ENVIRONMENTAL ISSUES:**

Yamaha strives to produce products that are both user safe and environmentally friendly. We sincerely believe that our products and the production methods used to produce them, meet these goals. In keeping with both the letter and the spirit of the law, we want you to be aware of the following:

## **Battery Notice:**

This product MAY contain a small non-rechargeable battery which (if applicable) is soldered in place. The average life span of this type of battery is approximately five years. When replacement becomes necessary, contact a qualified service representative to perform the replacement.

This product may also use "household" type batteries. Some of these may be rechargeable. Make sure that the battery being charged is a rechargeable type and that the charger is intended for the battery being charged.

When installing batteries, do not mix batteries with new, or with batteries of a different type. Batteries MUST be installed correctly. Mismatches or incorrect installation may result in overheating and battery case rupture.

## **Warning:**

Do not attempt to disassemble, or incinerate any battery. Keep all batteries away from children. Dispose of used batteries promptly and as regulated by the laws in your area. Note: Check with any retailer of household type batteries in your area for battery disposal information.

## **Disposal Notice:**

Should this product become damaged beyond repair, or for some reason its useful life is considered to be at an end, please observe all local, state, and federal regulations that relate to the disposal of products that contain lead, batteries, plastics, etc. If your dealer is unable to assist you, please contact Yamaha directly.

## **NAME PLATE LOCATION:**

The name plate is located on the bottom of the product. The model number, serial number, power requirements, etc., are located on this plate. You should record the model number, serial number, and the date of purchase in the spaces provided below and retain this manual as a permanent record of your purchase.

**Model**

---

**Serial No.**

---

**Purchase Date**

---

# PLEASE KEEP THIS MANUAL

# PRECAUTIONS

## PLEASE READ CAREFULLY BEFORE PROCEEDING

\* Please keep these precautions in a safe place for future reference.



### WARNING

**Always follow the basic precautions listed below to avoid the possibility of serious injury or even death from electrical shock, short-circuiting, damages, fire or other hazards. These precautions include, but are not limited to, the following:**

- Do not open the instrument or attempt to disassemble the internal parts or modify them in any way. The instrument contains no user-serviceable parts. If it should appear to be malfunctioning, discontinue use immediately and have it inspected by qualified Yamaha service personnel.
- Do not expose the instrument to rain, use it near water or in damp or wet conditions, or place containers on it containing liquids which might spill into any openings.
- If the AC adaptor cord or plug becomes frayed or damaged, or if there is a sudden loss of sound during use of the instrument, or if any unusual smells or smoke should appear to be caused by it, immediately turn off the power switch, disconnect the adaptor plug from the outlet, and have the instrument inspected by qualified Yamaha service personnel.
- Use the specified adaptor (PA-3B or equivalent recommended by Yamaha) only. Using the wrong adaptor can result in damage to the instrument or overheating.
- Before cleaning the instrument, always remove the electric plug from the outlet. Never insert or remove an electric plug with wet hands.
- Check the electric plug periodically and remove any dirt or dust which may have accumulated on it.



### CAUTION

**Always follow the basic precautions listed below to avoid the possibility of physical injury to you or others, or damage to the instrument or other property. These precautions include, but are not limited to, the following:**

- Do not place the AC adaptor cord near heat sources such as heaters or radiators, and do not excessively bend or otherwise damage the cord, place heavy objects on it, or place it in a position where anyone could walk on, trip over, or roll anything over it.
  - When removing the electric plug from the instrument or an outlet, always hold the plug itself and not the cord.
  - Do not connect the instrument to an electrical outlet using a multiple-connector. Doing so can result in lower sound quality, or possibly cause overheating in the outlet.
  - Unplug the AC power adaptor when not using the instrument, or during electrical storms.
  - Before connecting the instrument to other electronic components, turn off the power for all components. Before turning the power on or off for all components, set all volume levels to minimum.
  - Do not expose the instrument to excessive dust or vibrations, or extreme cold or heat (such as in direct sunlight, near a heater, or in a car during the day) to prevent the possibility of panel disfiguration or damage to the internal components.
  - Do not use the instrument near other electrical products such as televisions, radios, or speakers, since this might cause interference which can affect proper operation of the other products.
  - Do not place the instrument in an unstable position where it might accidentally fall over.
  - Before moving the instrument, remove all connected adaptor and other cables.
  - When cleaning the instrument, use a soft, dry cloth. Do not use paint thinners, solvents, cleaning fluids, or chemical-impregnated wiping cloths. Also, do not place vinyl, plastic or rubber objects on the instrument, since this might discolor the panel or keyboard.
  - Do not rest your weight on, or place heavy objects on the instrument, and do not use excessive force on the buttons, switches or connectors.
  - Use only the stand/rack specified for the instrument. When attaching the stand or rack, use the provided screws only. Failure to do so could cause damage to the internal components or result in the instrument falling over.
  - Do not operate the instrument for a long period of time at a high or uncomfortable volume level, since this can cause permanent hearing loss. If you experience any hearing loss or ringing in the ears, consult a physician.
- #### ■ REPLACING THE BACKUP BATTERY
- This instrument contains a non rechargeable internal backup battery which permits internal data to remain stored even when the power is off. When the backup battery needs replacing, the message "Battery Low" will display in the LCD. When this happens, immediately back up your data (using an external device such as the floppy disk-based Yamaha MIDI Data Filer MDF3), then have qualified Yamaha service personnel replace the backup battery.
  - Do not attempt to replace the backup battery yourself, in order to prevent the possible serious hazards. Always have qualified Yamaha service personnel replace the backup battery.
  - Never place the backup battery in a location that a child can reach, since a child might accidentally swallow the battery. If this should happen, consult a physician immediately.
- #### ■ SAVING USER DATA
- Save all data to an external device such as the Yamaha MIDI Data Filer MDF3, in order to help prevent the loss of important data due to a malfunction or user operating error.
- Yamaha cannot be held responsible for damage caused by improper use or modifications to the instrument, or data that is lost or destroyed.

Always turn the power off when the instrument is not in use.

# About This Manual

Congratulations on your purchase of the CS2x Control Synthesizer! And thank you for choosing Yamaha.

The CS2x introduces a completely new dimension to the enormously popular CS1x, providing more great sounds, additional SOUND CONTROL knobs for broader real-time sound sculpting capabilities, plus other handy features which provide for greater overall operational convenience and performance flexibility.

This owner's manual is your personal "hands on" guide to getting the most from your CS2x — so be sure to keep it in a safe and accessible place for quick and easy reference whenever you may need it! It is divided into the following sections:

## Getting Started

This section includes everything you need to get to know the CS2x inside and out. It is divided into four parts: Welcome To The World Of CS2x Control Synthesis, Setting Up The CS2x, Getting To Know The CS2x, CS2x Quick Tour.

## Feature Reference

This section provides descriptions of CS2x features and explanations of operations. It is in essence a dictionary which you can refer to any time you need to know the specifics about any given feature. It is organized into the following sections: Performance Mode, Multi Play Mode, Utility Mode, Store Mode and Factory Settings.

## Appendix

This section provides information related to the digital effects, MIDI, error messages, troubleshooting and more.

A separate CS2x Control Synthesizer "Data List" book provides tables, lists and other information related to Preset Performances, normal and drum voices, MIDI Data Format and more.

## Naming Conventions

For maximum ease of understanding, two basic conventions are used throughout this manual regarding the names of CS2x features, as follows:

- The names of specific buttons located on the panel are placed inside brackets, e.g. [ARPEGGIO] button, [PERFORMANCE] button, [USER] button, etc.
- The names of other panel features and terminals are printed in all-caps just as they appear on the panel, e.g. PITCH wheel, TO HOST terminal, EFFECT REV SEND parameter, etc.

The illustrations and LCD screens as shown in this owner's manual are for instructional purposes only, and may be different from the ones on your instrument.

The company names and product names in this owner's manual are the trademarks or registered trademarks of their respective companies.

# CONTENTS

<b>Getting Started .....</b>	<b>6</b>
<b>Welcome To The World Of CS2x Control Synthesis .....</b>	<b>6</b>
Main Features .....	7
Top Panel .....	8
Rear Panel.....	10
<b>Setting Up The CS2x.....</b>	<b>11</b>
Basic Connections .....	11
Powering Up! .....	14
Playing The Demo Songs .....	14
<b>Getting To Know The CS2x .....</b>	<b>15</b>
CS2x Tone Generation .....	15
Normal Voices And Drum Voices .....	18
Layers .....	18
Knob Parameters.....	19
Panel Edit Parameters .....	20
Operating Modes .....	21
<b>CS2x Quick Tour.....</b>	<b>23</b>
Performance Mode .....	23
Performance Selection .....	23
Performance Mode Select .....	23
Performance Bank Select .....	23
Performance Number Select .....	23
Performance Play .....	25
Octave Shift Function .....	25
PITCH And MODULATION Wheels .....	25
Scenes And SCENE CONTROL Function .....	25
Performance Editing And Store .....	26
SOUND CONTROL Knobs .....	26
The Arpeggiator .....	27
Panel Edit Matrix .....	29
User Performance Store .....	30
Multi Play Mode.....	31
Sequencer Setup .....	31
Multi Play Mode Select .....	31
Part Assign .....	32
Part Parameter Edit .....	32
XG Operation .....	33
Multi Play In Performance Mode .....	33
Using The CS2x With XGworks .....	34
<b>Feature Reference .....</b>	<b>40</b>
<b>Performance Mode .....</b>	<b>40</b>
Common Edit 1 .....	43
Common Edit 2 .....	45
Layer Edit 1.....	47
Layer Edit 2.....	50
Layer Edit 3.....	52
Layer Edit 4.....	54
<b>Multi Play Mode.....</b>	<b>57</b>
<b>Utility Mode.....</b>	<b>61</b>
<b>Store Mode.....</b>	<b>66</b>
<b>Factory Settings .....</b>	<b>69</b>
<b>Appendix .....</b>	<b>70</b>
<b>Digital Effects .....</b>	<b>70</b>
<b>About MIDI .....</b>	<b>72</b>
<b>Specifications .....</b>	<b>76</b>
<b>Troubleshooting .....</b>	<b>77</b>
<b>Error Messages .....</b>	<b>78</b>
<b>Index .....</b>	<b>79</b>

# Getting Started



## Welcome To The World Of CS2x Control Synthesis

Whether you're a beginner and the CS2x is your very first professional synth, or you're a seasoned professional making a living entertaining the masses — or whether you style yourself as anything in between — you're sure to find the CS2x to be one of the finest electronic musical instruments you'll ever own. It's certainly one of the most *fun*.

It can be said that the CS2x is a sort of *analog-style digital synth*. It takes the best of traditional analog — such as simplicity of use, natural “hands on” interactivity, broad dimensions of sound, an Arpeggiator, and a wealth of real-time control features — and unites it with the best of modern digital — such as stable pitch, a full 64 notes of polyphony, one-touch setting reconfigurations, a generous 16 MB of Wave ROM plus lots of storage memory, comprehensive MIDI features, and much, much more.

Another great thing about the CS2x is that there are no pages and pages of hard-to-get-at hidden functions. Literally everything you need is laid out right before your eyes. And simply a press of a button — or twist of a knob — away. Since all complicated concepts and frustration factors are eliminated right from the start, the CS2x is quick and easy to learn to operate.

And if you should ever need to use the CS2x as a multitimbral tone generator, you'll find it the ideal MIDI system component since it's designed to accommodate XG and General MIDI System Level 1 (GM) formats with ease. It also lets you set up your own configuration of multiple timbres using a unique “4-Layer plus 12-Part” system that lets you keep your Performance timbre intact. There's even a stereo mini plug input which lets you “mix” the stereo or mono audio signals of an external component such as a sampler or submixer with the CS2x's audio output.

All things considered, the CS2x is sweet and simple — but incredibly powerful. Capable of holding its own in literally any music situation, it's an exciting world of modern music that you'll be proud to be a part of.



### GM System Level 1

“GM System Level 1” is a standard specification that defines the arrangement of voices in a tone generator and its MIDI functionality, ensuring that data can be played back with substantially the same sounds on any GM-compatible tone generator, regardless of its manufacturer or model. Tone generators and song data that meet the “GM System Level 1” bear this GM logo.



### XG

“XG” is a tone generator format that expands the voice arrangement of the “GM System Level 1” specification to meet the ever-increasing demands of today's computer peripheral environment, providing richer expressive power while maintaining upward compatibility of data. “XG” greatly expands “GM System Level 1” by defining the ways in which voices are expanded or edited and the structure and type of effects.

When commercially available song data bearing the XG logo is played back on a tone generator which bears the XG logo, you will enjoy a full musical experience that includes unlimited expansion voices and effect functions.

## Main Features

The CS2x is designed for maximum real-time control during performance. This makes it the ideal choice for Dance DJs, Rhythm And Rhyme MCs, Drum & Bass and Techno musicians — and anyone else whose music thrives on a cutting edge synth sound. It's also an ideal multitimbral "module" fit for any type of MIDI system. Following is a list of the CS2x's main features.

- **16 MB Wave ROM With AWM2 Voices**  
AWM2 (Advanced Wave Memory 2) voices are comprised of actual digital recordings, or samples, of real musical instrument and other sounds. Voices available for use include 586 normal voices and 20 drum voices (kits) for GM and XG format applications in Multi Play mode, plus much more.
- **256 Preset And 256 User Performances**  
A "Performance" is a complete configuration of a *Layer* (up to 4 voices either stacked or playing in sophisticated keyboard and velocity splits) plus digital effects selections, Arpeggiator and many other parameter settings. Performance mode — the chief operating mode for real-time play — has 256 great-sounding Preset Performances plus 256 User Performances for storing your own.
- **8 Real-time Sound Control Knobs And "Scenes"**  
The SOUND CONTROL knobs give you direct access to key parameters of the currently selected Performance as you play. Each Performance has two Scene memories, each of which provides instant recall of specific SOUND CONTROL knob positions. You can use the MODULATION wheel or a connected Foot Controller to "morph" between the sound of each Scene during performance.
- **Arpeggiator With 40 Patterns**  
The Arpeggiator lets you select from 40 types of arpeggiated chord patterns and 10 timing subdivisions. Included are Up, Down and Up/Down patterns across one or more octaves, plus various special patterns including Techno, House, Random, Echo&Pan and more. All Arpeggiator settings are stored as part of each Performance. The Arpeggiator's tempo can be controlled by an external MIDI clock, and the Arpeggiator data can be output via MIDI.
- **3 Programmable Digital Effects Units**  
The three independent DSP digital effects units — Reverb (12 types), Chorus (14 types) and Variation (62 types) — can all be used simultaneously.
- **Easy Connection To And Use With A Computer**  
A built-in TO HOST terminal plus HOST SELECT switch permits direct connection to an IBM PC/AT or Apple Macintosh computer without the need for any peripheral interface hardware. Multi Play mode allows for multitimbral play of up to 16 different Parts (across 16 MIDI channels, when using an external sequencer) with 64 notes of available polyphony.

# Top Panel

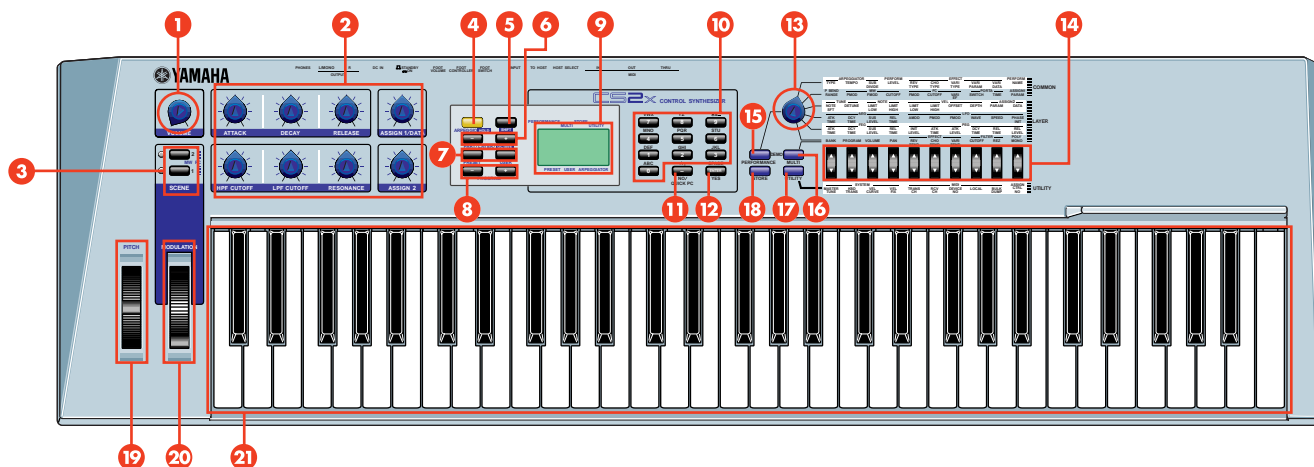

## 1 VOLUME knob

This knob controls the CS2x's overall audio volume level output from the PHONES and OUTPUT jacks. Turn it between left-most (minimum) and right-most (maximum) positions to set the proper listening level whether using headphones or amplified speakers.

## 2 SOUND CONTROL knobs

The eight SOUND CONTROL knobs are used for real-time control and edit of various tone generator parameters. Turning a knob to the left or right will offset its specified parameter values accordingly (left for negative values, right for positive values). Each knob has a detented center stop position which represents the original value of the parameter. (page 19.)

## 3 [SCENE] buttons

Each of the CS2x's 512 Performances has two "Scene" memories in which are stored the specific positions of the eight SOUND CONTROL knobs, giving you the capability of slight or even radical sound reshaping at the press of a [SCENE] button. Simultaneously pressing both [SCENE] buttons activates the SCENE CONTROL function, which lets you use the MODULATION wheel or a connected Foot Controller to "sound morph" between the two Scenes. (page 25.)

## 4 [ARPEGGIO] button

Pressing this button turns the Arpeggiator on and off. When the Arpeggiator is on, you can create automatic arpeggiated chords as you play. You can designate arpeggio type, tempo and timing subdivision using the panel edit functions. An ARPEGGIATOR SPLIT function lets you split the keyboard at C3 so the chords you play to the left of the split point will create arpeggiated chords and everything from the split point and above will play as normal. An ARPEGGIATOR HOLD function will cause arpeggiated chords to continue playing even after you release the keys. (page 27.)

## 5 [SHIFT] button

This button has three functions. (1) Holding [SHIFT] and pressing OCTAVE [-]/[+] transposes the octave of a Performance or voice up or down (page 25). (2) Holding [SHIFT] and pressing [ARPEGGIO] turns the ARPEGGIATOR HOLD function on and off (page 27). (3) Holding [SHIFT] and pressing ARPEGGIATOR TYPE [UP/DOWN] (in Performance Edit mode when the Arpeggiator Type screen is displayed) turns the ARPEGGIATOR SPLIT function on and off (page 27).

## 6 PART/LAYER/OCTAVE [-]/[+] buttons

These two buttons have three functions. (1) In Performance mode you can use them to select one of the four Layer voices (page 29). (2) In Multi Play mode you can use them to select one of the 16 Parts (page 32). (3) When used in conjunction with the [SHIFT] button you can use them to transpose the octave of the Performance or voice up or down (page 25).

## 7 [PRESET] and [USER] Performance buttons

Pressing one of these buttons lets you access a Preset or User Performance bank in Performance Play mode. Each time you press [PRESET] or [USER] toggles between P1 and P2 or U1 and U2 banks, respectively. Each bank contains 128 Performances, making a total of 512 available. (page 23.)

## 8 PROGRAM [-]/[+] buttons

Each time you press one of these buttons lets you step up ([+]) or down ([-]) through each consecutive Performance (in Performance mode) or voice (in Multi Play mode). Holding either switch lets you continuously "scroll" through the list of programs.

## 9 LCD

The backlit LCD screen displays various types of information to indicate the current operating status of the CS2x, depending on which mode or particular function is selected.



## 10 NUMERIC KEYPAD

The NUMERIC KEYPAD is used in conjunction with the [ENTER/YES] and [-/NO/QUICK PC] buttons and has several functions. In Performance mode or Multi Play mode you can use it to select a specific Performance or voice program number (page 24) as well as for selecting a program number when the QUICK PROGRAM CHANGE function is active (page 41). In Edit mode you can use it to input positive or negative numeric data values (page 42) or to select characters when naming a User Performance (page 45).

## 11 [-/NO/QUICK PC] button

This button has three functions. (1) As a [-] button you can use it to enter negative data values in Edit mode (page 42). (2) As a [NO] button you can use it to cancel a store operation if you change your mind (page 66). (3) As a [QUICK PC] button you can use it to activate the QUICK PROGRAM CHANGE function (page 41).

## 12 [ENTER/YES] button

This button is used as an [ENTER] button in conjunction with the NUMERIC KEYPAD in order to enter a specific program number in Play mode (page 24) or data value in Edit mode (page 42). It is used as a [YES] button to confirm store operations (page 66).

## 13 EDIT PARAMETER ROTARY switch

In Performance mode this six-position switch lets you select one of the two COMMON or four LAYER menus of parameters (page 41). In Multi Play mode only the bottom menu of parameters are available, regardless of the current position of the switch (page 57).

## 14 Parameter Value [UP/DOWN] buttons

Used for accessing and editing specific panel parameters and settings, each of these ten buttons corresponds to a parameter name printed on the panel above or below a given [UP/DOWN] button. Press it once to enter Edit mode and display the parameter screen in the LCD. Press the [▲] area to increase and the [▼] area to decrease values. Holding down either area will continuously scroll through available settings. In Performance Edit mode, the position of the EDIT PARAMETER ROTARY switch determines which COMMON or LAYER parameter is available for each button. In Multi Part Edit mode, only the parameters printed directly above the buttons are available. In Utility mode, only the parameters printed directly below the buttons are available.

## 15 [PERFORMANCE] button

Pressing this button activates Performance mode, which lets you select any of the Preset or User Performances, use the SOUND CONTROL knobs and SCENE functions, as well as activate the Arpeggiator and COMMON and LAYER edit parameters. Press [PERFORMANCE] to enter Performance mode from another mode, or to exit Edit mode and redisplay the Performance Program Select screen after performing a panel edit operation. (page 23.)

## 16 [MULTI] button

Pressing this button activates Multi Play mode, which lets you select and play any of the 586 XG voices, as well as designate up to 16 Parts for multitimbral play (when using an external sequencer). Parameters which can be edited in Multi Play Edit mode are printed in a row directly above the Parameter Value [UP/DOWN] buttons. (page 31.)

### DEMO function

Pressing [PERFORMANCE] and [MULTI] simultaneously activates the factory-programmed demonstration songs (page 14).

## 17 [UTILITY] button

Pressing this button activates Utility mode, which lets you access those “system” parameters that affect the CS2x as a whole, including MASTER TUNE, MIDI TRANSMIT and RECEIVE CHANNEL numbers, keyboard LOCAL on/off setting, etc., as printed directly below each Parameter Value [UP/DOWN] button (page 61).

## 18 [STORE] button

This button is used when performing User Performance, Scene and Multi Store operations (page 66).

## 19 PITCH wheel

This controller lets you bend the pitch up or down as you play. It is spring-loaded to automatically return to center position when you let go of it. In Performance mode you can determine the extent of pitch change using the PITCH BEND RANGE edit function (page 45).

## 20 MODULATION wheel

This controller lets you apply or set a designated amount of vibrato or tremolo as you play. You can also set it to affect filter cutoff, filter modulation, and pitch modulation (page 46) as well as other controllable parameters (page 64). When the SCENE CONTROL function is active it can be used to “morph” the sound in real-time between the two Scenes.

## 21 Keyboard

The 61-key touch-sensitive keyboard features Initial Touch (velocity) control.

# Rear Panel

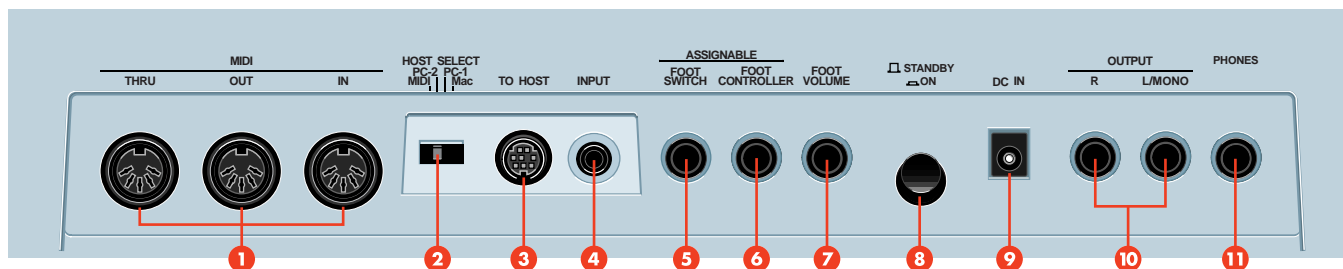

## 1 MIDI terminals

The MIDI terminals let you connect external MIDI devices such as a sampler, drum machine, sequencer, or computer using MIDI cables. MIDI IN is for input of MIDI note and other performance-related data, as well as bulk data dumps from another CS2x or MIDI data storage device. MIDI OUT is for output of MIDI note and other performance-related data, as well as for bulk data dumps to another CS2x or MIDI data storage device. MIDI THRU is for “daisy chain” connection of multiple MIDI instruments, as the MIDI data received at MIDI IN is passed along unaffected to MIDI THRU. (NOTE: Set HOST SELECT to “MIDI” when using the MIDI terminals.)

## 2 HOST SELECT switch

This switch lets you designate the type of host computer, either PC1, PC2, Mac, or MIDI (page 13). (NOTE: When a host computer is not connected, set HOST SELECT to “MIDI” for normal MIDI transmission and reception.)

## 3 TO HOST terminal

This terminal lets you connect the CS2x directly to a host computer which does not have a MIDI interface (page 13).

## 4 INPUT jack

This jack lets you connect an external audio source (such as a sampler, CD player, etc.) directly to the CS2x using either a stereo or mono mini plug. The incoming audio signals are combined and output at the CS2x's OUTPUT terminals, thus eliminating the need for an external mixer. To control the relative balance of the signals, use the external device's output volume control and the CS2x's panel edit PERFORM LEVEL parameter (Performance mode; page 44) or VOLUME parameter (Multi Play mode, page 59).

## 5 FOOTSWITCH jack

By connecting an optional Yamaha FC4 or FC5 footswitch to this jack you can control hold on/off, portamento on/off and other parameters, determined by the ASSIGN CTRL NO (Assign Control Change Number) setting in Utility mode (page 64).

## 6 FOOT CONTROLLER jack

By connecting an optional Yamaha FC7 or FC9 foot controller to this jack you can control filter modulation, filter cutoff, and the Variation effect (page 12), as well as the Control Change Number (page 64). You can also use it for “sound morphing” between Scenes when the SCENE CONTROL function is active (page 25).

## 7 FOOT VOLUME jack

By connecting an optional Yamaha FC7 or FC9 foot controller to this jack you can regulate overall volume by foot.

## 8 STANDBY/ON switch

This switch is for turning the power of the CS2x on and off (page 14).

## 9 DC IN terminal

This terminal is for connection of the supplied Yamaha PA-3B Power Adaptor. (CAUTION: Do not attempt to use an AC adaptor other than the Yamaha PA-3B or equivalent, since the use of an incompatible adaptor may cause irreparable damage to the CS2x, and may even pose a serious shock hazard.)

## 10 OUTPUT jacks

The stereo OUTPUT jacks let you connect the CS2x to an external stereo amplifier/speaker system. When using a mono system, use the L/MONO jack. (page 11.)

## 11 PHONES jack

This jack lets you connect a set of stereo headphones for private listening (page 11).

This section steps you through the basic connections required for integrating the CS2x into everything from a simple amplification system to a full-blown MIDI music studio. Also included is information about turning on the power and listening to the preprogrammed “Demo” songs.

## Basic Connections

There are many ways to incorporate the CS2x into a simple or expanded music system. Below are a few examples to get you started.

### Power Adaptor

The CS2x comes equipped with a Yamaha PA-3B AC adaptor which supplies DC power to the instrument.

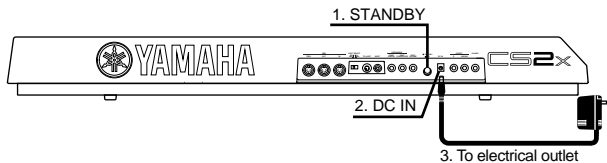

1. Make sure the STANDBY/ON switch is in the STANDBY (off) position.
2. Connect the PA-3B's DC plug to the CS2x's DC IN jack.
3. Connect the adaptor's AC plug to the nearest electrical outlet.

**CAUTION** Do not attempt to use an AC adaptor other than the PA-3B. Use of an incompatible adaptor may result in irreparable damage to the CS2x, and could even pose a serious shock hazard.

Be sure to disconnect the power adaptor from the electrical outlet when the CS2x is not in use.

### The CS2x By Itself

At the simplest level, all you need to do to monitor the CS2x is connect a pair of stereo headphones to the PHONES jack located on the rear panel.

Or you could connect a pair of amplified speakers (i.e. speakers with their own built-in amps, like those used with a personal computer) using two audio cables plugged into the CS2x's left and right OUTPUT jacks and each amplified speaker's input jack. (For mono use, connect one end of a single audio cable to the CS2x's L/MONO jack.)

Or if you want to integrate the CS2x into a larger system with other instruments and additional audio processing capabilities, connect it to a mixer, amplifier and stereo monitor system as shown below.

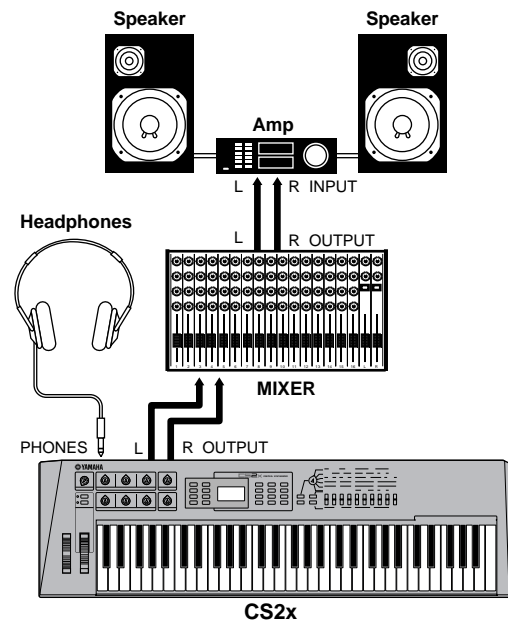

**CAUTION** In order to avoid possible damage to the speakers or other connected electronic equipment, before switching on the power of any component, make sure the CS2x's volume level and the volume levels of the connected equipment are set to minimum.

## Connecting A Foot Controller

In addition to the on-board SOUND CONTROL knobs and other real-time controllers, you can connect an optional Yamaha FC7 or FC9 foot controller to the CS2x's FOOT CONTROLLER jack and assign one of many available parameters to be controlled by foot.

1. Connect the FC7 or FC9 cable to the CS2x's FOOT CONTROLLER jack.

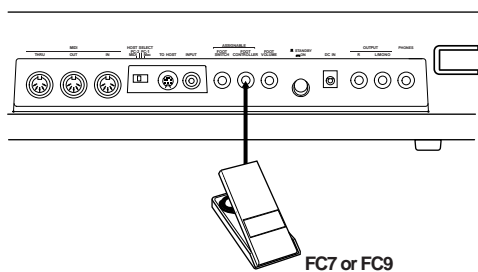

2. Press the [UTILITY] button to enter Utility mode.
3. Press the ASSIGN CTRL NO [UP/DOWN] button once.

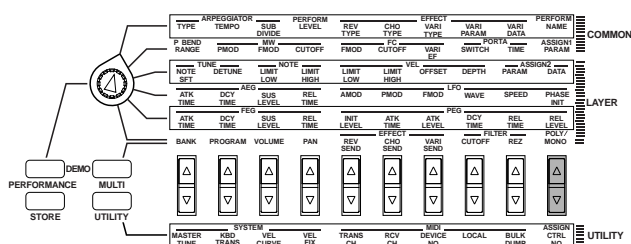

4. Move the foot controller pedal to display "FC" in the LCD.



5. Use the ASSIGN CTRL NO [UP/DOWN] button to select the Control Change Number and Name of the parameter that you want to control.

For information about available Control Change Numbers and Names, see page 65.

**NOTE** You can also connect an FC7 or FC9 foot controller to the CS2x's FOOT VOLUME jack and assign a parameter to it in the same way as described above.

## Connecting External MIDI Components

There are many different types of MIDI components available which you could connect directly to the CS2x using MIDI cables to take advantage of the CS2x's multitimbral features and greatly expand your music production capabilities. Following is an example of how to connect an external sequencer and additional tone generator to build up a comprehensive music production system.

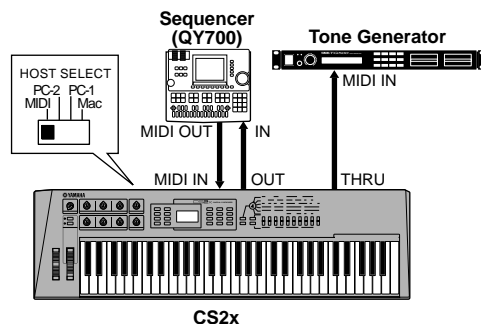

1. Set the CS2x's rear panel HOST SELECT switch to MIDI.
2. Connect a MIDI cable from the CS2x's MIDI OUT terminal to the sequencer's MIDI IN terminal. Connect another MIDI cable from the CS2x's MIDI IN terminal to the sequencer's MIDI OUT terminal.
3. Connect a MIDI cable from the CS2x's MIDI THRU terminal to the tone generator's MIDI IN terminal

In this monster system, the CS2x is the "master keyboard controller" used for music note and control data input into the QY700's MIDI channel tracks. The QY700 sends the recorded data directly to the CS2x's Parts, and — via the MIDI THRU terminal — to the external tone generator's Parts.

**NOTE** When recording Parts to an external sequencer, you need to turn the keyboard Local setting to OFF (page 63). For details about assigning CS2x MIDI transmit and receive channels, see page 63. For details about assigning MIDI channels and other settings for the external devices, consult the owner's manual of each.

## Connecting A MIDI Data Storage Device

By connecting a MIDI data storage device such as the Yamaha MDF3 MIDI Data Filer to the CS2x you can save a single User Performance or all the User Performances and Utility parameters to floppy disk using MIDI data “Bulk Dump” operations.

This lets you build up complete libraries of Performance and other data, which you can easily load back into the CS2x. (You can also play compatible song data on the CS2x directly from the MDF3 itself, without the need for a sequencer.)

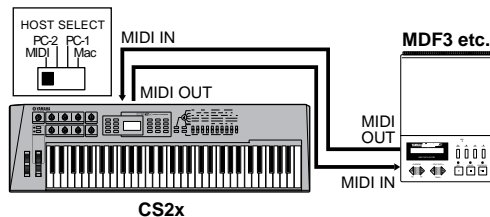

**NOTE** The **HOST SELECT** switch must be set to **MIDI**. For details about CS2x Bulk Dump operations, see page 64. (Also refer to the owner's manual of the MIDI data storage device for instructions about sending and receiving data.)

## Connecting A Computer

Using the CS2x with a computer permits the widest variety of options for getting the most from the CS2x's multitimbral music production capabilities based on the particular music sequencer software application you use.

With its built-in host computer interface (TO HOST terminal) the CS2x is designed for direct connection to an Apple Macintosh, IBM PC/AT or NEC PC-9800 Series computer — without the need for a special MIDI interface between the computer and the CS2x. (If your computer already has a MIDI interface installed, you may prefer to use it.)

Depending on the computer or interface used, you will need to use the appropriate MIDI/computer connecting cable (see following) as well as set the **HOST SELECT** switch to either **PC-1** (NEC PC-9800 Series), **PC-2** (IBM PC and clones), **Mac** (Macintosh), or **MIDI** (standard MIDI interface).

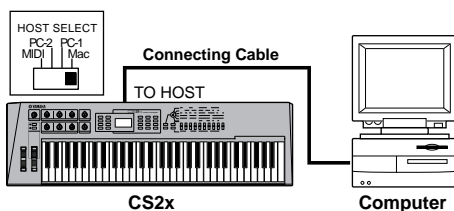

## Direct Connection To Macintosh

If you have an Apple Macintosh not equipped with an external MIDI interface, perform the following operation:

1. Set the **HOST SELECT** switch to **Mac**.
2. Connect the cable from the CS2x's **TO HOST** terminal to the Macintosh's **Modem or Printer port**.
3. Turn on the power of the host computer, then the CS2x.
4. Launch the music software application, and set up the software options for operation with the CS2x.

**NOTE** You may have to set the Apple MIDI Driver setting as follows: **MIDI Interface Type (Clock) → 1MHz**. Other settings may also be required. Refer to the owner's manual of your particular music software for more information.

## Direct Connection To IBM PC and Clones

If you have an IBM PC/AT or compatible computer not equipped with an external MIDI interface, perform the following operation:

1. Set the **HOST SELECT** switch to **PC-2**.
2. Connect the cable from the CS2x's **TO HOST** terminal to one of the computer's serial ports, **COM 1** or **COM 2**.
3. Turn on the power of the host computer, then the CS2x.
4. Launch the music software application, and set up the software options for operation with the CS2x.

**NOTE** For more information, refer to the owner's manual of your particular music software.

### MIDI/Computer Connecting Cables

**MIDI** Standard MIDI cable, maximum length 15 meters.

**Mac** Apple Macintosh Peripheral cable (M0197), maximum length 2 meters.

**PC-1** 8-pin MINI DIN to D-SUB 25-pin cable, maximum length 1.8 meters. (If your PC-1 type computer has a 9-pin serial port, use the PC-2 type cable.)

**PC-2** 8-pin MINI DIN to D-SUB 9-pin cable, maximum length 1.8 meters.

## Powering Up!

Now that you've made all your audio and MIDI connections properly, you're ready to switch on the power and get down to the business of enjoying the CS2x in all its glory! Here's the basic procedure:

1. Turn the CS2x VOLUME knob to its minimum position.
2. Press the STANBY/ON switch, located on the rear panel. After a brief greeting message appears in the LCD, the CS2x will be ready to play.
3. Gradually turn the VOLUME knob to the right while playing the keyboard until you achieve a comfortable listening level.

**CAUTION** In order to avoid possible damage to the speakers or other connected electronic equipment, always switch on the power of the CS2x before switching on the power of the amplified speakers or mixer and amplifier. Likewise, always switch off the power of the CS2x after switching off the power of the amplified speakers or mixer and amplifier.

**CAUTION** Even when the switch is in the "STANDBY" position, electricity is still flowing to the instrument at a minimum level. When not using the CS2x for an extended period of time, be sure to unplug the AC power adaptor from the wall AC outlet.

## Playing The Demo Songs

Before you get carried away exploring the many Performances and other great features of the CS2x, you may want to listen to the preprogrammed demonstration songs.

The demonstration songs provide dynamic and stunning examples of just how powerful the CS2x really is. To play the DEMO, perform the following operation:

1. Hold the [PERFORMANCE] button, then press [MULTI].

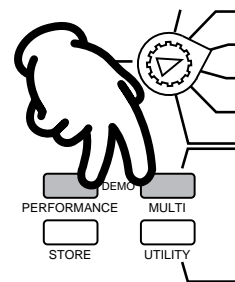

2. The word "DEMO" will appear in the LCD, and after a brief moment the first demonstration song will begin, and will be immediately followed by the next, and the next, and so on.
3. To stop the Demo at any time, simply press a mode button such as [PERFORMANCE].

**NOTE** When the Demo mode is engaged, you can select a particular Demo song by pressing a number on the NUMERIC KEYPAD.



## CS2x Tone Generation

The CS2x Control Synthesizer — and the way it creates its myriad sounds — is a natural evolution of the various types of popular synthesizers that have come before it over the past several decades.

It all started with the popular analog “voltage controlled” synthesizers used on the hit recordings of the 1960s and ‘70s. Although they were far from perfect — suffering from lack of storage, unstable tuning and limited polyphony — they had knobs that were pretty easy to use and even to this day are known as the “vintage” synths now sought after by the world’s top dance music artists.

Then came the digital breakthroughs of the early 1980s — personified by Yamaha’s DX7 which dispensed with knobs altogether and introduced the world to practical polyphonic synthesis. With its voice storage, MIDI and other capabilities it literally redefined what a synthesizer was all about, although to many it was a bit difficult to program.

Next came digital sampling — a field in which Yamaha has also been at the forefront with its *Advanced Wave Memory* (AWM) technology — which nothing less than revolutionized popular music itself and is still immensely popular to this day.

Now comes the CS2x with its convenient digital features plus knobs and other analog-style functions. Combining the best of both analog and digital worlds, the CS2x is truly a unique — and completely modern — electronic instrument that’s as easy to understand and operate as it is fun and intuitive to play.

What this means in practical terms is that the CS2x provides you with hundreds of great sampled sounds, or “voices” built right in, the detailed characteristics of which you can manipulate in real-time as you play using the eight SOUND CONTROL knobs and other handy controllers. These and many other parameter editing functions let you quickly and easily customize as many sound setups that you may need for a tune, and then store them in “Performance” and “Scene” memories for instant recall at the touch of a button!

### Generating Sounds Electronically

For the sake of the uninitiated, let’s take a look at some basic facts regarding the nature of sounds and how they are generated electronically. There are three basic elements which make up any type of sound, whether acoustically oriented or electronically generated, as follows:

- PITCH**, or how low or high a sound is;
- tone**, or what a sound’s overall timbre, or quality is like;
- AMPLITUDE**, or how loud a sound’s volume level is.

In the simplest terms, acoustic musical instruments are specifically designed and painstakingly built to produce precise sound characteristics over a determined range when played. This is why a violin always sounds like a violin, a piano always sounds like a piano, and a flute always sounds like a flute. A musician’s playing techniques are also extremely important.

For example, a violinist will “scrape” the bow across the string at a certain intensity to generate violin sound waves at a certain volume level (amplitude) and produce low or high notes based on fingering positions (pitch). The vibrating strings and resonating wood, as well as the playing style and techniques of the musician, will determine the overall quality of the violin’s timbre (tone).

## Oscillators, Filters, Amplifiers And Envelope Generators

Synthesizers rely on three distinct electronic components to imitate or “synthesize” the soundwaves of musical instrument voices as well as create entirely new sounds. In traditional analog synthesis the fundamental source sound pitch is generated by an *oscillator*, its tone is created by a *filter*, and its volume is determined by an *amplifier*.

Another key component is known as the *envelope generator* (EG). An envelope generator determines how the pitch, filter or amplifier behaves over time to create greater dynamics. The EG affects specific sound levels over time through “ADSR” stages, or Attack (initial fade-in time), Decay (the time it takes to reach the Sustain level), Sustain (the specified level while a key is held) and Release (the time it takes for the level to reach zero after releasing the key).

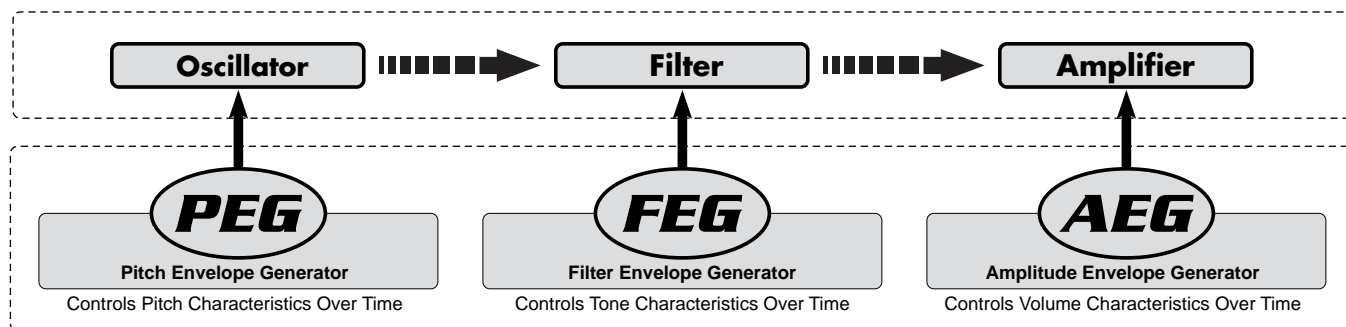

**OSCILLATOR**

Frequencies generate the pitch of specific notes

1 octave  
1 octave

1 cycle per second = 1 Hz  
\* Doubling the frequency increases pitch by one octave  
\*\* Halving the frequency decreases pitch by one octave

The oscillator generates sound wave vibrations at controllable speeds, or *frequencies* (“cycles per second”) to create pitch. A frequency *cycle* is the time it takes for a sound wave to go from its zero position (represented by the dotted line in the illustration) to its point of maximum peak (top), back past zero to its maximum trough (bottom), and finally back to zero. Frequencies are measured in “Hertz” (Hz), where one cycle per second is equal to one Hz. Synthesizer oscillators usually offer a range of frequencies between 20 Hz and 20kHz to generate pitch, which is the range of the “audio spectrum” that most human beings can hear. They also usually offer various types of sound waveforms with specific shapes and sound characteristics, such as sine, sawtooth, square, pulse and other waves. Oscillators in the CS2x, unlike traditional analog synthesizers, consist of complete AWM2-type sampled “waveforms” with stable tuning. You can use the PEG (Pitch Envelope Generator) parameters to directly control the critical pitch characteristics over time.

**FILTER**

The number of harmonics can be increased and decreased

Harmonics

More harmonics creates a brighter tone  
Less harmonics creates a darker tone

Basic tone ↑

Musical instrument sounds are made up of the basic tone that we clearly distinguish with our ears plus additional harmonics, or overtones which exist at each octave above the basic tone, but that we cannot distinctly hear. The filter provides control over these harmonics. By manipulating the filter’s cutoff frequency (which determines where to delete, or cut off the overtones) and resonance settings, you can thus determine the tone. With the CS2x, you can use the FEG (Filter Envelope Generator) parameters to directly control the critical tone characteristics over time, as well as control cutoff, resonance and other parameters to shape the tone.

**AMPLIFIER**

A tone’s volume level can be controlled over time

Lower volume level  
Higher volume level

An amplifier controls the volume of the tone. The CS2x has an AEG (Amplitude Envelope Generator) which lets you control various volume characteristics over time.



## How The CS2x Generates Sound

The diagram and accompanying information below explains the CS2x's tone generation architecture and the key components which go into making up an AWM2 voice, as well as the types of controls and parameters which you can apply to the voice.

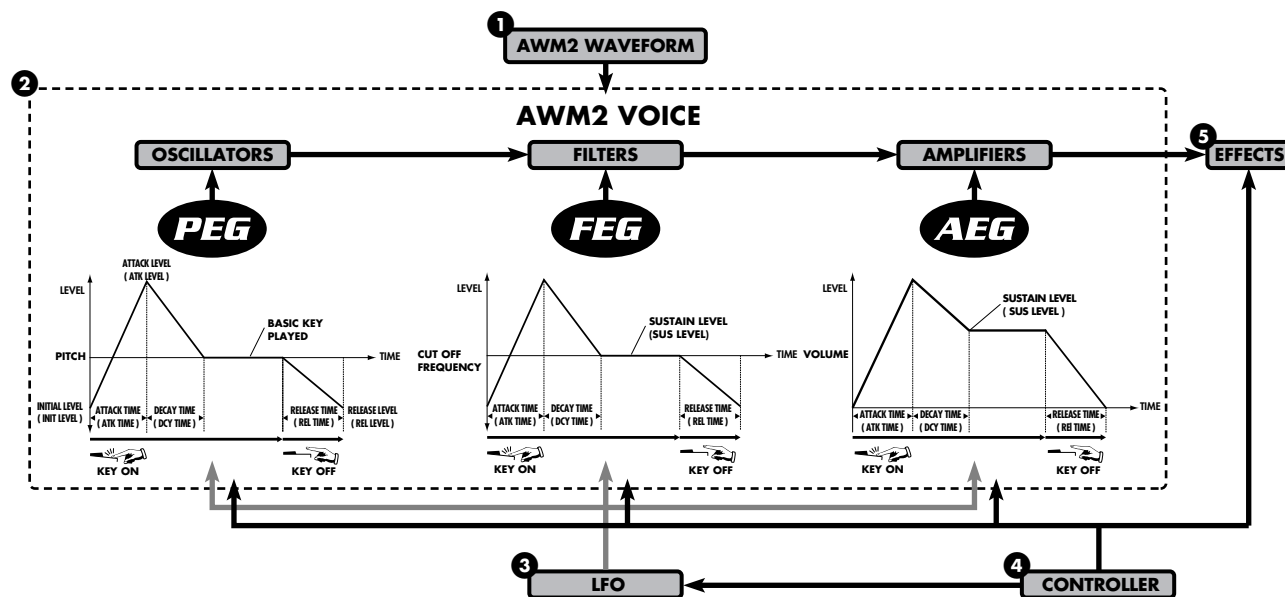

**1 AWM2 Waveform** The fundamental source of the CS2x's sound is the sampled AWM2 waveform. There are hundreds preprogrammed in ROM which are used by the Performances.

**2 AWM2 VOICE** The AWM2 waveform combines with the oscillator, filter and amplifier to make up a CS2x voice.

- **PEG** The Pitch Envelope Generator controls how the pitch changes over time. INIT LEVEL (Initial Level) sets the initial pitch level when a key is played. ATK TIME (Attack Time) determines the time required for a sound to reach its Attack Level after a note is played. ATK LEVEL (Attack Level) sets the initially targeted level after a note is played. DCY TIME (Decay Time) determines the time required for a sound to reach its basic pitch from the Attack Level while the key is held. REL TIME (Release Time) determines the time it takes for the basic pitch to reach the Release Level after the key has been released. REL LEVEL (Release Level) sets the final targeted level after the key is released.
- **FEG** The Filter Envelope Generator controls how the timbre changes over time. ATK TIME (Attack Time) determines the time required for a sound to reach its maximum cutoff frequency level when a note is played. DCY TIME (Decay Time) determines the time required for a sound to reach its Sustain Level from the maximum level while the key is held.

SUS LEVEL (Sustain Level) sets the Sustain Level; the cutoff frequency will be maintained at this level for as long as the key is held.

REL TIME (Release Time) determines the time it takes for the cutoff frequency to reach the level preset for each voice after the key has been released.

- **AEG** The Amplitude Envelope Generator controls how the volume changes over time. ATK TIME (Attack Time) determines the time required for a sound to reach its maximum volume level when a note is played. DCY TIME (Decay Time) determines the time required for a sound to reach its Sustain Level from the maximum volume level while the key is held. SUS LEVEL (Sustain Level) sets the Sustain Level; the volume will be maintained at this level for as long as the key is held. REL TIME (Release Time) determines the time it takes for a sound to sustain after the key has been released.

**3 LFO** The Low Frequency Oscillator generates low frequency signals which can be used to modulate the PEG, FEG and AEG.

- **PMOD** The LFO can apply Pitch Modulation to the PEG to create vibrato effects.
- **FMOD** The LFO can apply Filter Modulation to the FEG to create wah-wah types of effects.

● **AMOD** The LFO can apply Amplitude Modulation to the AEG to create tremolo effects.

**4 CONTROLLER** You can use several types of controllers to manipulate various parameters in realtime.

- **MW** Use the Modulation Wheel to control PMOD, FMOD, and Filter Cutoff.
- **FC** Use the Foot Controller to control FMOD, Filter Cutoff, and Variation Effect.
- **SOUND CONTROL KNOBS** The eight sound SOUND CONTROL knobs let you control AEG Attack, Decay and Release Times, HPF and LPF Cutoffs, LPF Resonance, and more (page 19). The ASSIGN 1/DATA and ASSIGN 2 knobs can be specified to control one of many types of available parameters (see the lists on pages 47 and 65).

**5 EFFECTS** Available effects which can be applied to a voice depend on whether the CS2x is in Performance mode or Multi Play mode.

# Normal Voices And Drum Voices

As explained in the previous section, an AWM2 waveform is the fundamental source of a CS2x “voice”, which also consists of oscillator, filter and amplifier settings.

The CS2x has two types of voices in memory which are preset at the factory: *normal* voices and *drum* voices. A normal voice is a typical pitched musical instrument voice such as piano, strings, brass, etc. A drum voice is an entire drum kit which has various bass, snare, toms, hi-hat, cymbals and other acoustic or electronic percussion and effects sounds that are “mapped” to specific keys on the keyboard.

## Layers

Although the individual AWM2 voices sound great in their own right, the CS2x lets you use up to four of them at the same time to create a *Layer* in Performance mode. You can designate all of these to sound simultaneously — to build up an incredibly rich sonic tapestry — or you can “map” specific Layer voices to various note and velocity zones across the keyboard to create amazingly complex sound textures that behave in a variety of ways depending on which notes you play or how hard you strike the keys.

The best way to find out just how exceptional Layers can be is to step through the 256 Preset Performances programmed at the factory. As you do so, you might find it helpful to take a look at the separate “Data List” book’s Preset Performance list which contains information about how many Layer voices are used and other chief settings for each Performance.

In Performance mode there are a considerable number of COMMON and LAYER parameters available that you can control or edit which affect all Layers equally or individual Layer voices, respectively (see following).

**NOTE** For more information, see pages 41 and 58. Also see the separate “Data List” book for voices available for use in Performances.

# Knob Parameters

The eight SOUND CONTROL knobs give you direct access to a variety of important parameters of the Performance. Turning any SOUND CONTROL knob to the left or right will offset its parameter values accordingly (based on knob positions: left for negative values, right for positive values). Each SOUND CONTROL knob has a center detent, or stop position which represents the original value of the parameter.

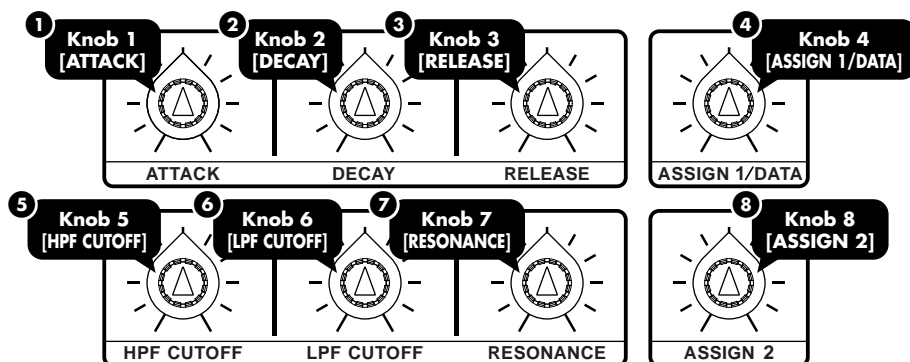

## Attack, Decay & Release Knobs

These knobs let you control the initial Amplitude Envelope Generator characteristics of the timbre.

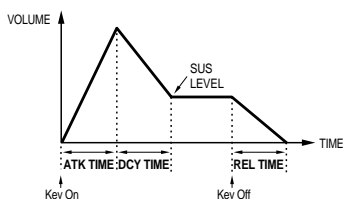

### 1 [ATTACK] (Knob 1)

This knob controls the initial AEG attack time of the voice. Turn it left for a faster attack time, or right for a slower attack. (page 50.)

### 2 [DECAY] (Knob 2)

This knob controls the AEG decay time of the voice. Turn it left for a shorter decay time, or right for a longer decay. (page 50.)

### 3 [RELEASE] (Knob 3)

This knob controls the AEG release time of the voice. Turn it left for a shorter release time, or right for a longer release time. (page 51.)

### 4 [ASSIGN 1/DATA] (Knob 4)

This knob has two functions. As an ASSIGN 1 knob, you can assign one of many parameters — including Performance Volume, Arpeggiator Tempo or Type, Portamento Time, and others — to control by turning it (page 47). As a DATA entry knob, you can use it to quickly change the edit value of the currently selected edit parameter.

## HPF Cutoff, LPF Cutoff & Resonance Knobs

These knobs let you control the filter settings which determine the sound quality of the timbre.

### 5 [HPF CUTOFF] (Knob 5)

This knob determines the cutoff frequency of the high pass filter. The cutoff is the frequency point below which other frequencies are deleted, or filtered out. Turn it left to lower the cutoff point and fatten the sound, or right to raise it and thin out the sound.

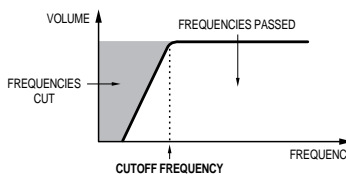

### 6 [LPF CUTOFF] (Knob 6)

This knob determines the cutoff frequency of the low pass filter. The cutoff is the frequency point above which other frequencies are deleted, or filtered out. Turn it left to lower the cutoff point and make the sound darker, or right to raise it and make the sound brighter. (page 55.)

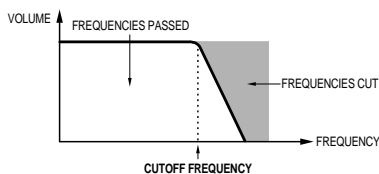

### 7 [RESONANCE] (Knob 7)

This knob determines the amount of filter resonance or emphasis of the cutoff frequency of the low pass filter. Turn it left to produce a relatively flat response, or right to add overtones and make the sound more resonant. (page 55.)

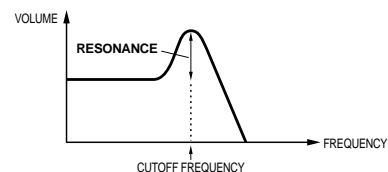

### 8 [ASSIGN 2] (Knob 8)

This knob can be used to control any one of many parameters which you can assign to it — including Volume, Note Shift, Pan, Chorus Send, and others. (page 49.)

## Edit Mark



In Performance mode, an edit mark will appear in the LCD between the Performance bank and number to indicate that the original Performance has been edited.

# Panel Edit Parameters

There are numerous parameters available in the panel edit matrix of menus. In Performance mode, all you have to do is set the EDIT PARAMETER ROTARY switch to the menu you want, then press the [UP/DOWN] button directly below the name of the parameter you want to edit. In Multi Play or Utility modes, the position of the EDIT PARAMETER ROTARY switch doesn't matter because there is only one menu of parameters available for each.

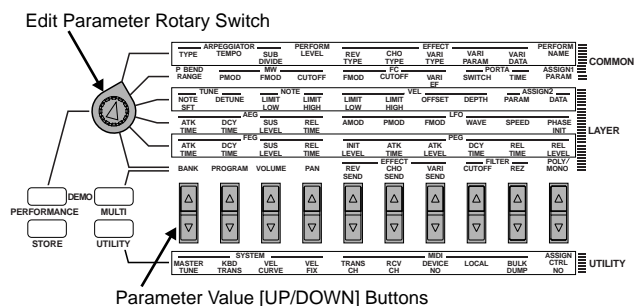

Simply pressing any [UP/DOWN] button once will activate Edit mode and display the name of the corresponding parameter in the LCD screen, along with the current setting. There are three ways to change the parameter value setting:

1. Press or hold the [▲] area of the [UP/DOWN] button to increase values, or the [▼] area to decrease values.
2. Enter the number of the value you want using the NUMERIC KEYPAD, followed by [ENTER] (for negative values, press [-] before entering the number).
3. Turn the ASSING 1/DATA knob left or right to change the values when the knob is designated as a DATA ENTRY function.

Following is a description of the types of parameters available for editing:

**COMMON** Available in Performance mode only, the COMMON parameters in the Common Edit 1 and 2 menus apply to the entire currently selected Performance. Except for the PORTA SWITCH setting, it doesn't matter which Layer is currently selected, since common parameters apply to all Layer voices equally. Changes to COMMON parameter settings will remain in effect as long as the current Performance is selected, but will be lost if you select a different Performance before performing a Performance store operation. (page 43.)

**LAYER** Available in Performance mode only, the LAYER parameters in the Layer Edit 1, 2, 3 and 4 menus affect only the currently selected Layer of the currently selected Performance. Changes to LAYER parameter settings will remain in effect as long as the current Performance is selected, but will be lost if you select a different Performance before executing a Performance store operation. (page 47.)

**MULTI** Available in Multi Play mode only, the MULTI parameters include voice, effect, and others which apply to the currently selected Part. There is memory space for a single set of MULTI parameter settings. Changes to the MULTI parameter settings will remain in effect as long as you remain in Multi mode, but will be lost if you switch into Performance mode before performing a Multi store operation. (page 58.)

**UTILITY** Available in Utility mode only, the UTILITY parameters consist of system, MIDI and type of data assignment (for the SOUND CONTROL knobs) which affect the CS2x as a whole. These settings will remain in effect regardless of whether you switch to Performance or Multi Play mode. (page 61.)

# Operating Modes

The CS2x has two main operating modes — Performance mode and Multi Play mode — both of which give you a range of options for real-time play as well as multitimbral Part play using an external MIDI sequencer for song production. There are also Utility and Store modes.

## Performance Modes

Performance mode — accessed by pressing the [PERFORMANCE] button — actually consists of Performance Play and Performance Edit modes. The diagram below provides an overview of the overall structure of key Performance mode components.

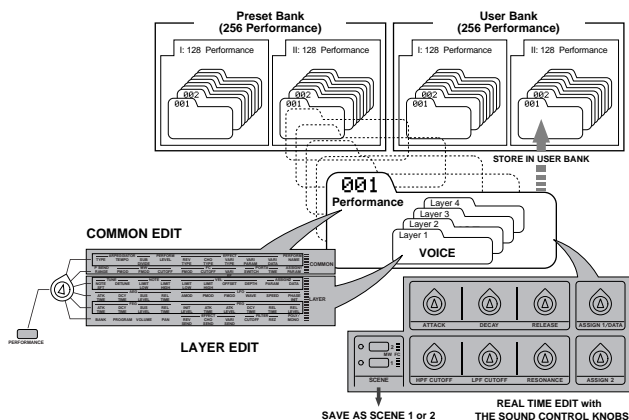

A *Performance* is comprised of up to four “Layers”, or AWM2 voices sounding at the same time — either playing simultaneously across the length of the keyboard, or playing independently according to specified key and velocity range settings — plus a variety of other settings which determine the behavior of the Arpeggiator, digital effects selection, characteristics of envelope generators, and much more.

## Performance Play Mode

In Performance Play mode you can select from 512 Performances — 128 of which are available in each of the two Preset Performance banks and 128 of which are available in each of the two User Performance banks — and begin playing the keyboard. As you play you can select one of two available Performance timbre variations by pressing a SCENE switch, or fade between (“morph”) the sounds of each Scene in real-time by pressing both [SCENE] buttons simultaneously (SCENE CONTROL function) then using the MODULATION wheel or a connected Foot Controller to precisely determine the relative volumes of each Scene timbre in relation to each other.

## Performance Edit Mode

Performance Edit mode is activated when you change a setting for any of the parameters available in the panel edit menus using the Parameter Value [UP/DOWN] buttons — which may affect all Layer voices equally (COMMON menu) or only the currently selected Layer voice (LAYER menu).

Adjustments you make using the SOUND CONTROL knobs or [UP/DOWN] buttons will *offset* (add to or subtract from) the parameter data values which are preset for each voice. An edit mark, or reversed type letter “E”, will appear in the LCD to indicate that a parameter has been changed. When you’re satisfied with the sound of the Performance, simply store it in any of the 256 User Performance memories using the Performance Store operation (page 66), before selecting a different Performance.

**NOTE** For more information about Performance mode, see page 40.

## Song Production In Performance Mode

Although Performance mode is primarily used for real-time playing, you can also use it for multitimbral operation in order to take advantage of Arpeggiator, Scene and other Performance mode-oriented functions not available in Multi Play mode. In such a case, one of the instrument “Parts” would be comprised of the Layer voices for the selected Performance. (For more information, see page 33.)

## Multi Play Mode

Multi Play mode — accessed by pressing the [MULTI] button — is primarily used for multitimbral song production and playback of up to 16 individual instrument “Parts” when an external MIDI sequencer is connected to the CS2x. The diagram below lists the available parameters for each Part.

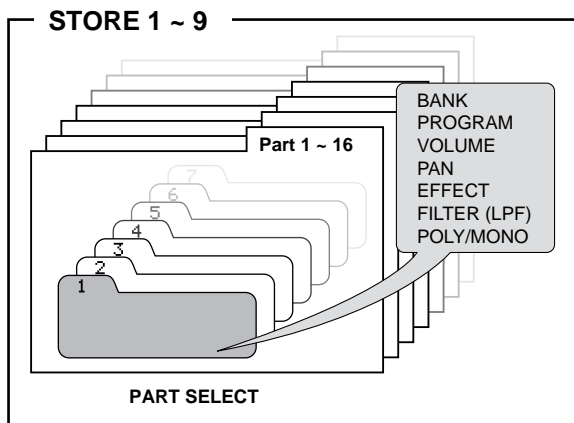

Although you can adjust various parameters in the Multi Part Edit menu to customize the selected voice, note that Scene, Arpeggiator and other Performance mode-oriented functions are not available.

When the edited Multi setup is just the way you want it, simply perform a Multi Store operation before switching into Performance mode (page 68).

**NOTE** With the GM format MIDI channel 10 is reserved for drum voices, which means you can select PART 10 to play the drums.

**NOTE** For more information about Multi Play mode, see page 57. For information about GM and XG, see page 33.

## Utility Mode

Utility mode lets you modify System, MIDI and controller assignment parameters which affect both Performance and Multi Play mode. For more information, see page 61.

## Store Mode

Store mode lets you store your own User Performances as well as Scenes and a Multi setup. For more information, see page 66.

This section provides you with a quick guided tour through all the fundamental CS2x operations in Performance mode, such as use of real-time control, Scene, Arpeggiator, panel edit and Performance Store functions. It also provides information about Multi Play mode and multitimbral operation, including Multi Play in Performance mode.

## Performance Mode

In Performance mode you can select from 256 Preset and 256 User Performances, use the SOUND CONTROL knobs to modify certain parameters as you play, select Scenes and use the SCENE CONTROL function for Scene morphing, and edit the values and settings of specific COMMON and LAYER parameters.

## Performance Selection

Following are the basic procedures for selecting CS2x Performances.

### Performance Mode Select

To enter Performance mode, simply press the [PERFORMANCE] button.

The basic Performance select screen will display in the LCD, with information about Preset or User bank selection, Performance name, program number (1 ~ 128) and category code, and more.

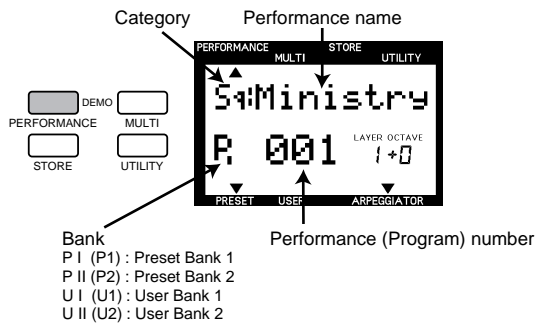

### Performance Bank Select

Individual Performances are stored in any one of four available banks. There are two Preset banks with 128 Performances each and two User banks with 128 Performances each.

To select one of the Preset banks, press [PRESET] once or more.

To select one of the User banks, press [USER] once or more.

Each time you press [PRESET] or [USER] toggles between P1/P2 or U1/U2 banks, respectively. The currently selected bank will display accordingly in the LCD screen.

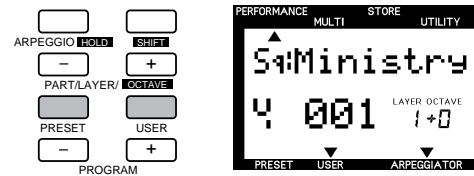

### Performance Number Select

There are two ways to select one of the 128 program numbers in each Preset or User Performance bank — by using the PROGRAM buttons or the NUMERIC KEYPAD.

#### PROGRAM Button Method

One way to select a Performance in the currently selected bank is as follows:

Press the PROGRAM [+] or [-] button once or more until you reach the number of the one you want (between 1 and 128).

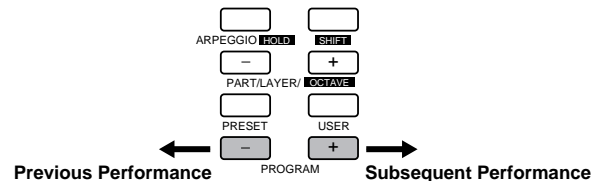

**NOTE** If you hold down the PROGRAM [+] or [-] button you can continuously scroll up or down through the list.

## NUMERIC KEYPAD Entry Method

Another way to select a Performance number in the currently selected bank is by using the NUMERIC KEYPAD. This is especially handy if you know the precise number of the Performance you want. Here's how:

1. Enter the specific number (1 ~ 128). The number will begin flashing in the LCD.

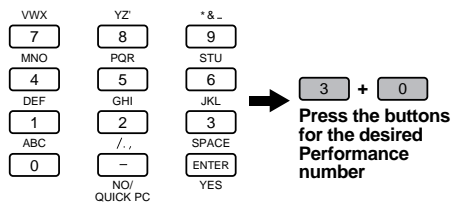

2. Press [ENTER]. This selects the Performance, so the number will stop flashing and remain displayed.

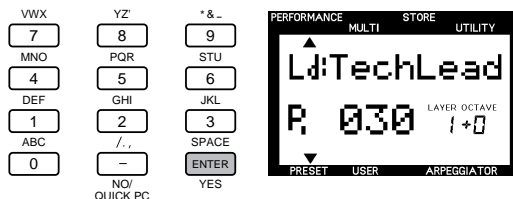

**NOTE** There's another way to quickly select a specific Performance program number within a group of 10 Performances — by using the Quick Program Change function (page 41).

## Category Codes

Each Performance (or voice in Multi Play mode) has a "Category" code assigned to it which helps you organize your Performances and voices by type for easier visual access. The following list describes each available Category.

NO.	LCD	Category Name
0	--	Not specified
1	Pf	Piano
2	Cp	Chromatic Percussion
3	Or	Organ
4	Gt	Guitar
5	Ba	Bass
6	St	Strings/Orchestral
7	En	Ensemble
8	Br	Brass
9	Rd	Reed
10	Pi	Pipe
11	Ld	Synth Lead
12	Pd	Synth Pad
13	Fx	Synth SFX
14	Et	Ethnic
15	Pc	Percussive
16	Se	Sound Effect
17	Dr	Drums
18	Sc	Synth Comping
19	Vo	Vocal
20	Co	Combination
21	Wv	Material Wave
22	Sq	Sequence

**NOTE** For details about assigning Category codes to User Performances, see page 45.



## Performance Play

After selecting a performance, you're ready to start playing the CS2x! As you do, you'll want to try out the various control and other features available in Performance mode. Let's continue with our step-by-step tour.

### Octave Shift Function

The CS2x's Octave Shift function is an easy way to transpose the octave of the Performance up or down by a maximum  $\pm 3$  octaves. Here's how:

1. To transpose the octave up, hold [SHIFT] and press OCTAVE [+] once or more.
2. To transpose the octave down, hold [SHIFT] and press OCTAVE [-] once or more.



**NOTE** The transpose value will also be reflected in the Utility mode's KEYBOARD TRANSCOPE function. Note that since the maximum is  $\pm 3$  octaves, when you raise or lower the keyboard transposition in semitones the full three octaves cannot be achieved by the Octave Shift function.

### PITCH And MODULATION Wheels

As you play, you can use the PITCH wheel to bend the pitch up and down, and the MODULATION wheel to apply varying degrees of modulation to the tone.

#### Using The PITCH Wheel

By rolling the PITCH wheel forward and back you can bend the pitch of the tone by the amount as determined by the P BEND RANGE parameter setting in the panel edit matrix (page 45).

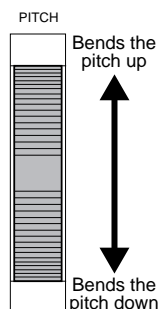

#### Using The MODULATION Wheel

By rolling the MODULATION wheel forward and back you can apply as much modulation to the tone as you want. The type of modulation which can be applied is determined by the three MW parameter settings in the panel edit matrix (page 46).

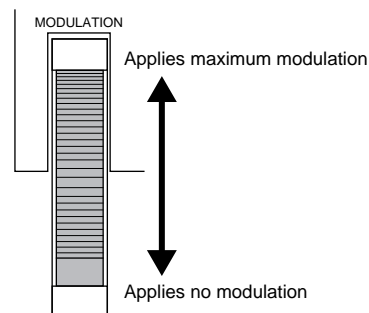

**NOTE** You can also use the MODULATION wheel for controlling volume, pan and others (page 64), as well as for SCENE CONTROL, or morphing (page 26).

### Scenes And SCENE CONTROL Function

Each Preset and User Performance has two Scene memories which are in essence "snapshots" of SOUND CONTROL knob positions (page 26). This gives you two additional sound textures available at the touch of a button! What's more, you can activate the SCENE CONTROL function which lets you "morph" the sound of one Scene into the sound of the other.

#### Scene Selection

To select Scene 1, press the [SCENE 1] button.

To select Scene 2, press the [SCENE 2] button.

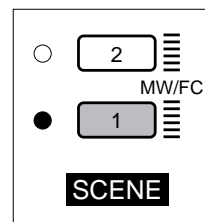

A red LED will light beside the currently selected Scene. To de-select the Scene, press the [SCENE] button again.

## ■ SCENE CONTROL Function

1. Press both [SCENE] buttons simultaneously.  
The red LED to the left of both [SCENE] buttons will light to indicate the SCENE CONTROL function is active.
2. Roll the MODULATION wheel forward and back to adjust the relative levels of each Scene.

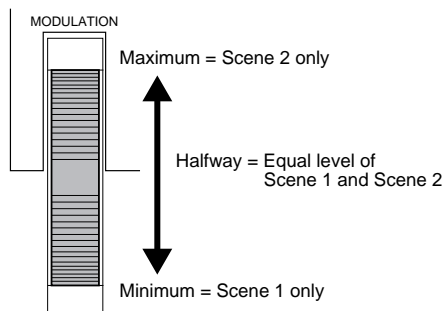

As shown in the illustration above, the position of the MODULATION wheel determines the relative levels of each Scene, with minimum controller position playing Scene 1 and maximum position playing Scene 2. Any position between the two extremes (between a range of 0 ~ 127) will play a blend of both Scenes accordingly.

**NOTE** You can also use a connected Foot Controller for SCENE CONTROL (pages 12 and 64).

## ■ Creating And Storing Scenes

You can easily create your own Scenes with the SOUND CONTROL knobs and store them in a Performance — either temporarily in the Scene buffer for the currently selected Preset or User Performance, or permanently in a User Performance. For details, see page 67.

## Performance Editing And Store

As a *control synthesizer* the CS2x features easy editing functions which are readily available as you play, including SOUND CONTROL knobs for direct tone modification, an Arpeggiator with a wide selection of arpeggiated chord types and timing resolutions, and many more. The next three steps on our tour are actually Performance Edit functions and as such will cause the edit mark (“E”) to appear in the LCD.

### SOUND CONTROL Knobs

The SOUND CONTROL knobs give you direct access to eight different parameters. All you have to do is turn them left and right to either slightly or radically alter the tone. They’re so much fun, you can literally get lost for hours at a time just tweaking the filters and resonance settings alone — so go ahead and try them all out!

The center stop position represents the original parameter settings as stored in the selected Performance, so it only takes a glance at the various knob positions to know where you stand. And don’t forget, if you come up with a tone you like, you can store it in one of the two Scene memories for instant recall (page 67).

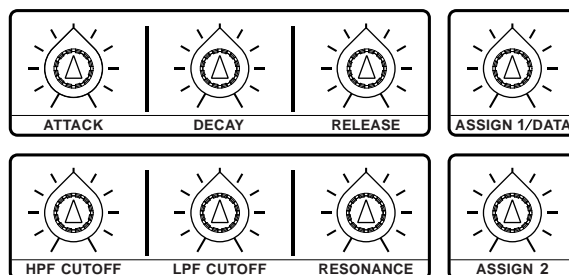

A description of the default function assigned to each SOUND CONTROL knob (printed on the panel below each knob) is provided on page 19. You can also assign whatever parameters you like to each knob using the panel edit matrix (page 64).

**NOTE** When a Scene is selected or the SCENE CONTROL function is active, turning the SOUND CONTROL knobs will have no affect on the tone.

## The Arpeggiator

The Arpeggiator is another function that you can get carried away with for hours on end! You've probably noticed by now that some Performances use the Arpeggiator as part of their makeup to generate arpeggiated chords automatically as you play. What's more, the Arpeggiator data can be output as MIDI messages via the MIDI OUT terminal and recorded by a connected music sequencer.

Just *how* they play depends on the TYPE, TEMPO, SUBDIVIDE and SPLIT settings available in the Common Edit 1 menu (page 43) plus the number of notes you play on the keyboard. (Performances with fast attacks tend to provide the best results.)

**NOTE** The Arpeggiator functions are not available in Multi Play mode.

### Arpeggiator On/Off

1. Press [ARPEGGIO]. An indicator will appear in the lower right area of the LCD above the word "ARPEGGIATOR".

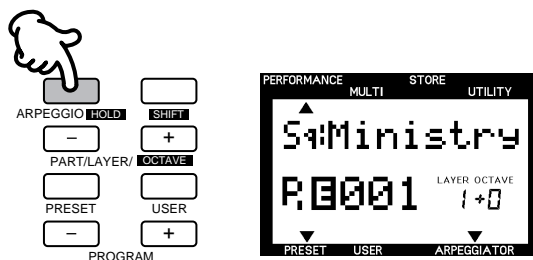

2. Play a series of chords and variate the number of notes (odd and even) to hear how differently the arpeggiated chords sound.

To turn off the Arpeggiator, press [ARPEGGIO] again.

### Arpeggiator Hold

The handy ARPEGGIATOR HOLD function lets you play a chord to start the automatic arpeggio, then take your hands away from the keyboard and have the arpeggios continue in a loop without stopping. When you play another chord the arpeggio will change accordingly.

1. Hold [SHIFT] and press [ARPEGGIO]. The "ARPEGGIATOR" indicator in the LCD will start blinking.
2. Play a chord and take your hand away. Then play other chords in the same way to get a feel for the right timing required.

To stop the arpeggiated chords, press [ARPEGGIO]. To turn off the ARPEGGIATOR HOLD function but leave the Arpeggiator on, hold a chord and press [ARPEGGIO] twice.

### Arpeggiator Split

The ARPEGGIATOR SPLIT function greatly increases the real-time performance capability of the CS2x. When ARPEGGIATOR SPLIT is activated, any chord you play to the left of the split point (B2 and below) will produce an arpeggiated chord, while chords you play to the right of the split point will play normally.

1. Press [ARPEGGIO] to activate the Arpeggiator function.
2. Set the EDIT PARAMETER ROTARY switch to the Common Edit 1 menu.
3. Hold [SHIFT] and press the left-most Parameter Value [UP/DOWN] button (ARPEGGIATOR TYPE parameter).
4. Pressing [UP] will turn on the ARPEGGIATOR SPLIT function.



A reversed type letter "S" will display in the LCD next to the TYPE name to indicate the ARPEGGIATOR SPLIT function is on. To turn it off, hold [SHIFT] and press [DOWN].

**NOTE** For more information, see page 44.

## ■ Arpeggiator Parameter Settings

The main Arpeggiator parameters include TYPE, TEMPO and SUBDIVIDE. TYPE determines the arpeggio characteristics (up, down, up and down, random, etc.). TEMPO of course controls the speed of the arpeggiated chords. SUBDIVIDE determines the arpeggio timing resolution (eighths, sixteenths, dotted notes, etc.).

1. Activate the ARPEGGIATOR HOLD function and play a chord.
2. Set the EDIT PARAMETER ROTARY switch to the Common Edit 1 menu.

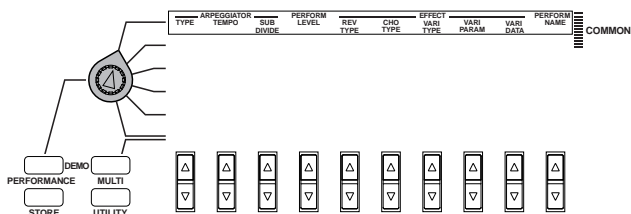

3. Press the TYPE [UP/DOWN] button and try out each available setting. Also press SUBDIVIDE [UP/DOWN] to hear how each of these settings affect each TYPE setting.

**NOTE** For more information, see *Arpeggio Pattern Length*, following, and page 43. Also see the *Arpeggiator Type List*, page 43.

## Arpeggio Pattern Length

The length of a CS2x arpeggio pattern is determined by three factors which work together simultaneously: TYPE and SUBDIVIDE settings, and the total number of notes you play for an arpeggiated chord.

For example, say you play an arpeggiated pattern with a four-note chord, such as a C major triad with an octave in the root. If SUBDIVIDE is set to "1/8", the Arpeggiator breaks down the chord into eighths, and then arpeggiates it based on the TYPE setting. If TYPE is set to "UpOct2" the arpeggio will climb over two octaves, and will repeat after four beats. Then, if you change SUBDIVIDE to "1/16", the arpeggio will repeat after two beats. Furthermore, if you then change TYPE to "UpOct1", the arpeggio will repeat after only one beat.

Because the number of notes you play in the chord has a direct relationship on the pattern length based on SUBDIVIDE resolution, sometimes unwanted syncopations may be generated. As a general rule, you can avoid this by choosing an even number of chord notes for even-numbered SUBDIVIDE resolutions (1/4, 1/8, 1/16 and 1/32) and an odd number of notes (e.g. three-note or five-note chords) with odd-numbered resolutions (1/6, 1/12, 1/24).

However, this doesn't apply for dotted note rhythms (3/8, 3/16 and 3/32). These resolutions are particularly interesting for odd-numbered beats (e.g. 3/8 or 6/8), so you will need to play chords with an even number of notes to correctly play back these three-part rhythms.

As an example, set TYPE to "UpOct2" and SUBDIVIDE to "3/8" resolution. Playing a triad will place the root note on the first beat in the fourth bar, generating irregular cycles. A four-note chord, however, generates symmetrical 4-bar cycles. The root note will be repeated after the first cycle on bar 3, after the second cycle on bar 5 and after the third cycle on bar 7, and so on, always landing on the first beat.

In the case of the special Arpeggiator types (16-40), you will notice that these aren't particularly effective with triplet rhythms. Best results are achieved with a 4/4 beat and a SUBDIVIDE resolution of "1/16", "1/8" or "1/32".

## Panel Edit Matrix

Although the features we've explained so far no doubt provide you with a wealth of tone control and great music making options, we've really only just begun to scratch the surface of the CS2x's power!

The panel edit matrix gives you six menus of Performance Edit parameters with virtually limitless options for tone control and customized User Performance creation using the EDIT PARAMETER ROTARY switch in conjunction with the ten parameter [UP/DOWN] buttons.

Each parameter is explained and available settings are listed in the Reference section (starting on page 39). Reading through it — along with just rolling up your sleeves and trying each one out one-by-one — will end up making you a veritable CS2x expert!

For the sake of giving you a well-rounded tour right now without getting in too deep, however, why not try experimenting with a few basic COMMON and LAYER edit menus to help you get comfortable dealing with collective and individual Performance Layers.

### COMMON Parameters

Each CS2x Performance is made up of anywhere between one and four Layer voices. Changes you make to parameter settings in the two COMMON menus will affect all Layer voices equally.

#### Try out the many different effects.

1. Set the EDIT PARAMETER ROTARY switch to the Common Edit 1 menu.

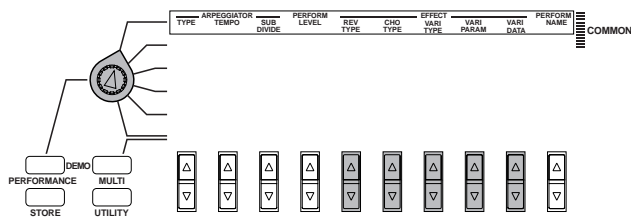

2. Use the REV TYPE [UP/DOWN] button to try out the different Reverb effect types. Use the CHO TYPE [UP/DOWN] button to try out the different Chorus effect types.

3. Use the VARI TYPE [UP/DOWN] button to try out the different Variation effect types. Use the VARI PARAM [UP/DOWN] button to select available Variation effect parameters. Use the VARI DATA [UP/DOWN] button to select specific parameter data value settings.

You can set the amount of Reverb and Chorus for each Layer using the EFFECT REV SEND and CHO SEND parameters, respectively, located in the Layer Edit 4 menu. When EFFECT VARI SEND is set to "on", however, Reverb and Chorus send levels are applied equally to all Layers.

**NOTE** For more information about effects, see page 70. Also see the separate "Data List" book.

#### Customize the parameter of the ASSIGN 1/DATA knob.

1. Set the EDIT PARAMETER ROTARY switch to the Common Edit 2 menu.

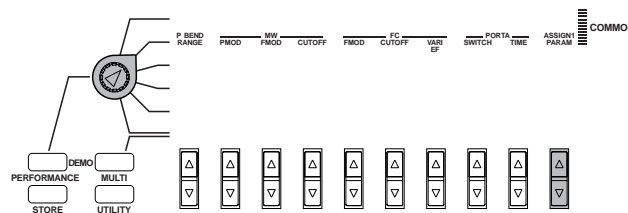

2. Use the ASSIGN1 PARAM [UP/DOWN] button to determine which parameter will be affected by the ASSIGN 1/DATA knob.

There are 30 choices in all. You could, for example, use it to control Arpeggiator tempo, or left and right panning of the sound, the overall pitch and much more.

**NOTE** For a list of available parameters, see page 65.

### LAYER Parameters

There are four menus of LAYER parameters which affect only the currently selected Layer when you edit them. (Note that although the PORTA SWITCH parameter is located in the Common Edit 2 menu, it is in fact a Layer parameter and therefore can be set for each individual Layer voice.)

#### Select a Layer.

Press the PART/LAYER [-] and [+] buttons to select a desired Layer.

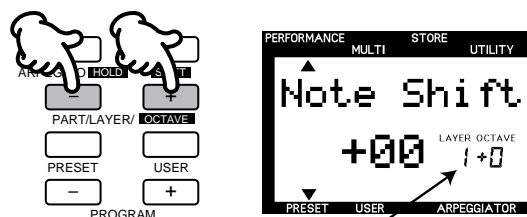

Indicates currently selected Layer

### Change the Layer voice.

This is a quick and effective way to easily create an entirely new Performance!

1. Select a desired Layer.
2. Set the EDIT PARAMETER ROTARY switch to the Layer Edit 4 menu and press the BANK [UP/DOWN] button to select an available bank.
3. Press the PROGRAM [UP/DOWN] button to select an available voice.

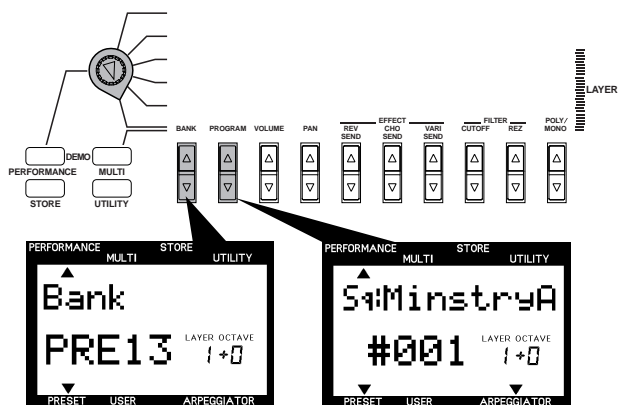

To assign a new voice to each Layer, simply repeat the process. When the BANK or PROGRAM screen is displayed, simply selecting a Layer will reveal which bank or voice is currently selected.

**NOTE** For a list of available voices for Performance Layers, see the separate "Data List" book.

### Adjust the relative volume levels of each Layer.

This is a quick and easy way to reshape a Performance which uses two or more Layers.

1. Select a desired Layer.
2. Set the EDIT PARAMETER ROTARY switch to the Layer Edit 4 menu and press the VOLUME [UP/DOWN] button to adjust the level.

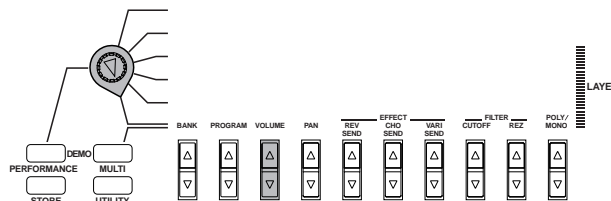

To set the level of each Layer, simply repeat the process. When the VOLUME screen is displayed, simply selecting a Layer will reveal its level setting.

## User Performance Store

Now that we're at the end of the Performance mode tour, it's highly likely that you created something along the way that's worth storing as a User Performance for recall later. In order to execute a Performance Store operation, the Performance Name screen must be displayed in the LCD.

1. Press the [STORE] button. The Performance Store screen will display.

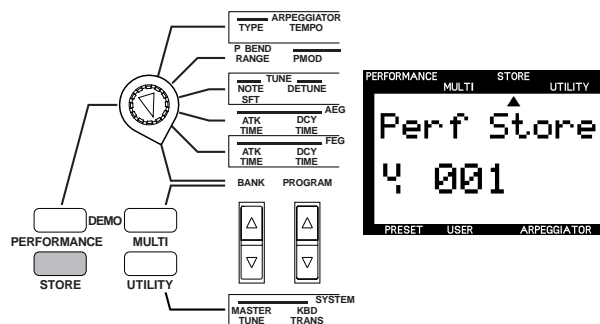

2. Press [USER] to select a User Performance bank (U1 or U2).
3. Use the NUMERIC KEYPAD to select the program number (1 ~ 128) in which you want to store the User Performance. The number will flash in the screen.
4. Press [ENTER].

A "Sure?" prompt will appear in the LCD. Press [YES] to store the Performance. Press [NO] to abort the operation.

## Multi Play Mode

Multi Play mode is especially suitable for multitimbral song production with up to 16 individual musical instrument “Parts” using an external MIDI sequencer or computer running a MIDI music sequencer program. Each CS2x Part is made up of one of the 586 normal voices and 20 drum voices as well as volume, panning, effect send and other settings. The CS2x’s 64 notes maximum available polyphony make sure even your most intricate composition will record and play back faithfully.

The CS2x is an excellent master MIDI keyboard controller for sequence recording since it not only transmits MIDI note messages as you play the keyboard, it also sends program change messages to change voices as you press panel buttons, and continuous control change message as you use the PITCH and MODULATION wheels, SOUND CONTROL knobs and Foot Controllers.

The CS2x is also an extremely flexible multitimbral MIDI “tone module” since it can receive MIDI system exclusive and other messages which give you far greater control over the individual effects and other parameters not possible using the panel functions. As an XG format tone generator the CS2x can play commercially available XG music data (marked with the XG logo) using an external sequencer as well as General MIDI System Level 1 files (marked with the GM logo). When used with a music sequencer software application such as Yamaha’s XGworks, you can enjoy the full benefits of the CS2x’s XG capabilities, all with an easy-to-use graphic-oriented user interface.

If you program the data for all of your basic voice, effects and other Part settings at the head of the song before the music starts, you can be assured that the CS2x will always play just as you want it to, without having to make any tedious panel settings when setting up.

In all, you can store up to nine CS2x Multi setups. Each might act as a template for an easy start to your most frequently used music composing, studio recording or live performance situations (page 67).

For the sake of the Quick Tour, we’ll explain the basic Multi Play mode setup operations, then give you a brief presentation of putting it all to practical use with a computer based music sequencer, Yamaha’s XGworks.

**NOTE** For more information, see pages 32 and 57. Also see the separate “Data List” book.

## Sequencer Setup

If you’re using a stand-alone hardware-based sequencer, connect it to the CS2x’s MIDI terminals using MIDI cables. If a computer, connect it to the TO HOST terminal using the appropriate cable. (For details about connections, see page 12.)

**NOTE** Refer to the owner’s manual for your sequencer regarding information about setting it up for multitimbral recording and play.

The following steps are related to setting up the CS2x for multitimbral recording and play.

## Multi Play Mode Select

Simply pressing the [MULTI] button will enter Multi Play mode.

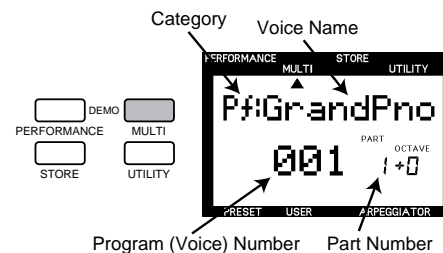

Take a look at the LCD and see which Part is selected (1 ~ 16). Note that if you play the keyboard the voice you’ll be playing will be that of the selected Part. You can use the NUMERIC KEYPAD (0 ~ 9) and [ENTER] as well as the PROGRAM [-]/[+] buttons to select any of the basic 128 GM normal voices.

A new CS2x or one that has had the factory settings recalled (page 69) will be set at PART 1 = “#001-Grand Piano”.

## Part Assign

You can assign any of the 586 XG normal voices (including the 128 GM voices) or 20 drum voices to each of the 16 Parts.

1. Use the **PART/LAYER [-]** and **[+]** buttons to select a desired Part, as displayed in the LCD.

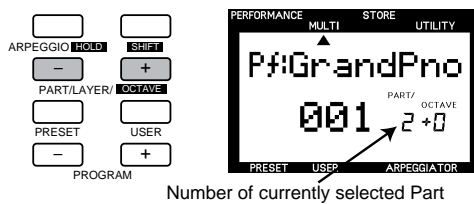

2. Use the **BANK [UP/DOWN]** button to select a desired voice bank.

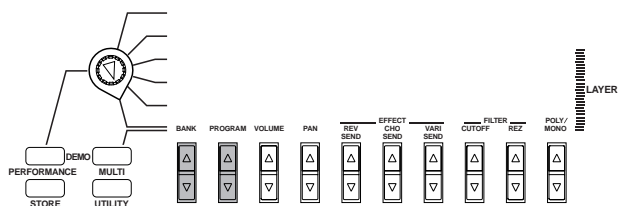

3. Use the **PROGRAM [UP/DOWN]** button to select a desired voice.

**NOTE** For a list of available banks and voices, see the separate "Data List" book.

## Part Parameter Edit

In Multi Play mode there is only one menu of edit parameters available, as printed directly above each [UP/DOWN] button. The position of the EDIT PARAMETER ROTARY switch is irrelevant.

1. Select a desired Part.
2. Use the [UP/DOWN] button directly below the name of the parameter which you want to edit to change the available settings.

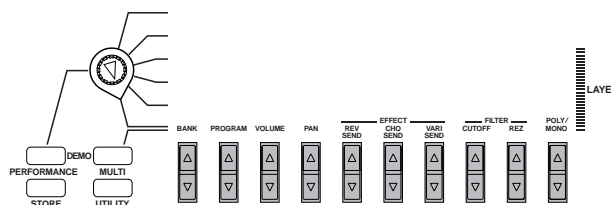

Repeat the procedure to edit each individual Part.

**NOTE** For details about each Multi edit parameter and available settings, see page 58.

**NOTE** For details about storing a User Multi, see page 68.



## XG Operation

XG represents the current state-of-the-art in multitimbral MIDI technology. In the early days of MIDI, it was very difficult to take music data created using one particular sequencer and play it back on another because the instruments assigned to the different parts were different for each maker and even individual composer. This meant that when different musicians came together with their varied MIDI instruments and music data, it required literally hours and hours of painstaking MIDI channel and other reassignment and checking operations before the music session could even begin! Thankfully those nightmare days are long gone.



General MIDI System Level 1 (GM) was created in order to standardize the voice assignments for 128 normal voices plus drums, so that songs created in the GM format would play back exactly as the

composer intended regardless of the tone generator manufacturer — as long as the device supported the GM standard as marked with the GM logo. These days virtually all electronic musical instruments and software-based music and game products support the GM standard.

GM is not without its limitations, however, which is why Yamaha created the XG format which maintains full compatibility with the basic MIDI and GM standards, while at the same time significantly increasing the range of expressiveness possible through much greater control over voice modifications and effects, plus provides for many more normal and drum voices to be available for use.



Many of the new XG voices are variations of basic GM voices which are stored in additional banks. Each bank is associated with a specific type of variation, so that voices are easy to

locate. When using an external sequencer to control the CS2x, additional banks are selected by the appropriate Bank Select LSB (Least Significant Bit) and MSB (Most Significant Bit) values.

The XG format also supports a full SFX bank of extension effects, which are selected by a Bank Select MSB value of 40H and LSB 0H.

What's more, the XG format also offers high level effects support, enabling control of effects types, circuit operation, plus internal parameter settings for both basic and elaborate effects. This means you can freely control the parameters of the CS2x's 12 Reverb, 14 Chorus and 62 Variation types of effects independently using an external sequencer.

The CS2x also features another play mode — TG300B mode — which lets you play back commercially available MIDI files in this format.

For more information about MIDI and MIDI related parameters, see page 72. Also see the separate "Data List" book.

## Multi Play In Performance Mode

While Multi Play mode is ideal for recording and playback of 16-part compositions using the XG voices, you can also use Performance mode for multitimbral play (using an external music sequencer) in order to enjoy the full benefits of the broader dimension of sound possible by the Preset or User Performances, plus Scene switching, arpeggiated chords and all of the SOUND CONTROL knobs.

To demonstrate how you can get the biggest benefits from the CS2x's multitimbral capabilities, we show you how to put its MIDI parameter control features into practical use by describing a few basic operations when using the CS2x with a computer and Yamaha's XGworks music sequencer application, a truly professional level MIDI music sequencer which features everything you'd expect from the world's most popular music software applications, plus the added benefit of greater ease of access to and control over XG commands. It even accommodates and lets you create songs in all popular formats, including as digital audio data such as WAV files.

When the CS2x is used for Multi Play in Performance mode, the Performance part is programmed as Part 1, and the 12 available voice parts are programmed in Parts 5 ~ 16. Which voice is used for each of the 12 Parts is determined by MIDI bank select, program change and other messages recorded as data in the sequencer tracks. (For more information, see pages 35 and 56.)

## Using The CS2x With XGworks

The XGworks Music Sequencer software application is a powerful all-in-one “DTM” Desktop Music composing, editing and mixing system for Windows95. XGworks is especially suited for the CS2x.

When you start up XGworks, you’ll be greeted by an Application Window from which you can access a variety of tools for recording and precise editing of your music.

In XGworks the Track View Window is the central point for song creation. There are many other tools you can use to construct your composition.

- The Piano Roll Window and the Drum Window let you edit MIDI notes graphically.
- The Staff Window displays the notes like sheet music.
- The List Window and the Master Track Window show the data for each MIDI event.
- The Mixer Window gives you the capability to control many different functions in realtime while playing back your song.
- The XG Editor Window lets you edit the parameters for the CS2x.

Every window has many functions which make operation intuitive and precise, while boosting your productivity and even having more fun!

**NOTE** XGworks operations may appear different depending on the version of XGworks and your computer conditions.

### 1. Set the CS2x MIDI Performance receive channels.

Using Utility mode, set the CS2x MIDI Receive Channel for the Performance (Part 1 = “A”), as well as Parts 5 ~ 16 (page 63), as the situation merits.

**NOTE** To select the Layer (“A”) or Part (“5 ~ 16”) which you want to assign a MIDI channel to, use the PART/LAYER [-]/[+] buttons.



**NOTE** If the Performance and another Part are set to the same MIDI receive channel number, then both timbres will play simultaneously. Keep this in mind as you set up your Parts, so that none will unintentionally play the wrong Part data.

**NOTE** When using the CS2x as the MIDI master keyboard device for MIDI data input, you determine which channel the CS2x is transmitting on using the Utility mode TRANS CH parameter (page 63).

### 2. Set the MIDI transmit channel for each Part track in XGworks.

The Track View Window lets you confirm the MIDI channels for each CS2x Part using the “Ch.” column.

#### Track View Window

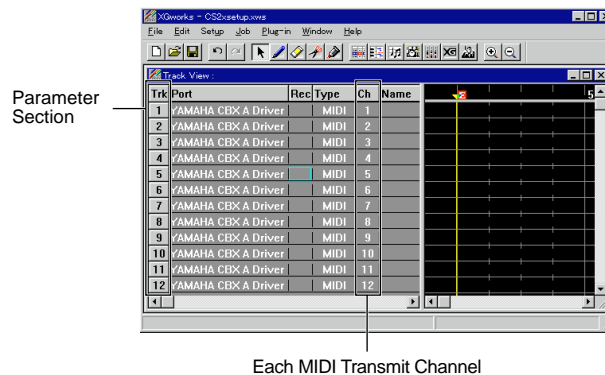

### 3. Decide the voice for each Part.

XGworks lets you use MIDI program change messages (page 75) to call up the CS2x's voices. There are many ways to do so. Take a look at the Track View Window.

Based on the MIDI standard, each voice has its own bank number and program number. Setting the appropriate bank select and program change values will call up a specific CS2x voice. You can set these in XGworks, with intuitive ease. You can assign a voice to each Part (5 ~ 16).

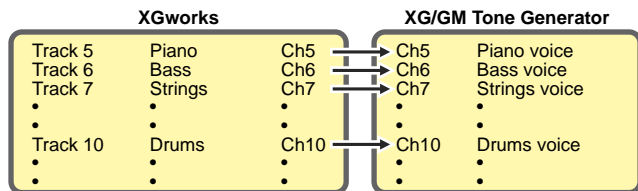

In the parameter section of the Track View Window you can open the Voice List. Like the CS2x, the voices are arranged in categories. As shown, you can easily locate and select a voice by choosing the basic category in column 1, which lists the types of voice categories available column 2. Choosing a type will list the available individual voices in column 3, available for selection.

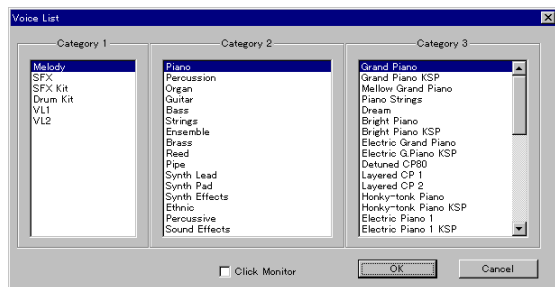

When you select a voice from the Voice List, that track's MIDI transmit channel transmits the bank number/program number (bank select/program change) to the same MIDI receive channel as set by the CS2x.

**NOTE** In order to ensure automatic setup of all voice and other parameter settings, you can insert the proper bank select/program change and other messages at the top of the song, before the music data starts playing. With XGworks this is all done with ease using the List Window.

**NOTE** For more information, see the owner's manual for XGworks.

**NOTE** The voice changes when the CS2x receives the corresponding bank select/program change messages. When you use this method, you can select not only each Part's voice but a Performance. The XGworks List Window makes this especially convenient. Since there are extra "material" voices available for use in Performance mode, you can assign any of these to Parts 5 ~ 16. For more information, see the separate "Data List" book.

### 4. Set the volume and panning for each Part.

You can control the CS2x's volume and panning for each Part using control change messages (page 72) to change the values of each, over a range of 0 ~ 127. From XGworks you can also change these manually using the Mixer Window. This sends the changes you make to volume fader and pan settings for each individual MIDI channel as control change messages to each corresponding CS2x Part.



#### Creating The Setup Data

You can set up the basic part parameters on the CS2x. You can use the List Window to set up each track's bank select and program change data (for voices) at the top of the song as well as control change data (for volume, panning, effects, etc.) throughout the song so that the sequence software will play everything back just as you want.

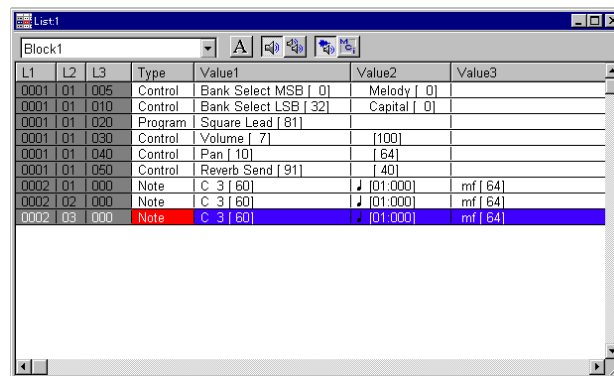

For details, see page 72.

You can program Performance data at the beginning of or throughout a song so that an original Performance is automatically selected for playback. This means that even if the particular User Performance is not stored in the CS2x, the appropriate data will be transmitted before the song data begins so that your song plays exactly as you recorded it.

It requires setting up the sequencer for a Bulk Dump request to receive the desired User Performance data. Following is an explanation of how to do so using the real-time recording function of XGworks as an example, where track 1 is used for programming the User Performance data.

### Transmitting Performance Data

1. In Performance mode, select the CS2x Performance you want to transmit.
2. In Utility mode (TRANS CH parameter), set the MIDI channel over which you want the CS2x to transmit the data, such as channel 1.



3. In Utility mode (BULK DUMP parameter), select the "1Perf" setting.



4. In XGworks, confirm that track 1 is set to channel 1 and prepare for real-time recording.

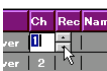

Confirm the channel

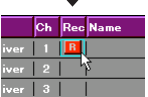

Select the track for recording



Press the Record button to activate recording Standby

5. After starting recording with XGworks, press the CS2x's [ENTER] button to transmit the Performance data.



Press the Play button to activate recording

VWX  
7

YZ'  
8

\*&...  
9

MNO  
4

PQR  
5

STU  
6

DEF  
1

GHI  
2

JKL  
3

ABC  
0

/.,  
-

SPACE  
ENTER  
YES

NO/  
QUICK PC

Bulk transmit start

6. When Performance data transmission is finished, stop the XGworks recording. Use the List Window to confirm the data received by XGworks. You can see that the MIDI data format (BULK DUMP "3-6-4-2", as shown in the separate "Data List" book) hexadecimal messages have been programmed.

### List Window

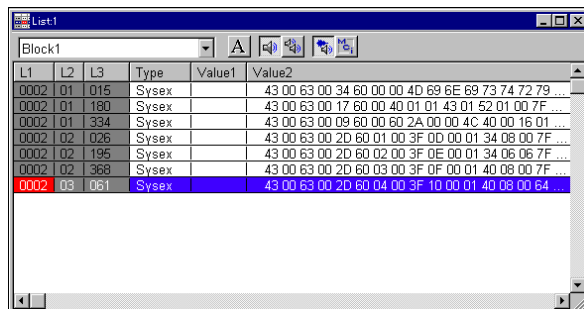

In the Track View Window you can use the Scissors and Eraser tools to delete data for measures that don't need data.

For information about saving, see the owner's manual for XGworks.

When you play a song with XGworks that has the received data, the appropriate CS2x Performance is selected automatically and played precisely as you recorded it.

**NOTE** Depending on system exclusive data programmed at the top of the song, you can have the sequencer automatically select Performance mode, using the system exclusive message as shown below. This way you can prevent an error caused by transmitting the Performance bulk data when the CS2x is in Multi Play mode.

**F0 43 1n 63 50 00 06 03 F7 (hexadecimal)**  
n = Device Number

These settings aren't limited for use with XGworks only, but will work with other sequencers as well. Refer to the owner's manual of the particular sequencer for related information.

## Simply Dynamite: Yamaha MIDI Magic

Yamaha has a full line-up of professional MIDI instruments from which you could choose in order to build up a MIDI music system that's perfect for your own individual needs. Two in particular are especially suited for use with the CS2x, as follows:

- QY700 Music Sequencer** Ideal for professionals and novices alike, the QY700 is a full MIDI production center in its own right complete with easy-to-use MIDI instrument and drum part composing through a built-in database of musical style phrases and "groove templates", 32 "linear" tracks and 16 "pattern" tracks, a full XG multitimbral tone generator including three digital multi-effects units, plus wide-ranging editing and on-board mixing features.

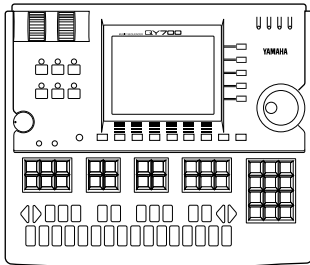

- RM1x Sequence Remixer** Ideal for dance DJs, the RM1x features the same basic sequencing and editing functions of the QY700 — along with hundreds of voices, 960 Preset patterns and 800 User patterns — plus real-time performance controls including a 16-key "microkeyboard" for easy switching of patterns and 8 CONTROL knobs for dynamic control of the sound on each track. There's also an arpeggiator, SMF compatibility, and much more.

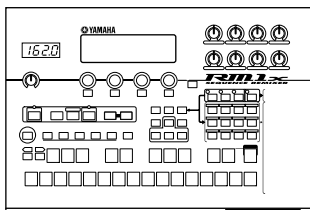





***Feature Reference***

CS2X

# Feature Reference

Following is a description of each function in the various modes along with available parameter settings.



## Performance Mode

In Performance mode you can choose from 256 Preset and 256 User Performances. A Performance consists of up to four "Layer" voices playing simultaneously. You can easily edit each Layer within a Performance so that each sounds and behaves uniquely. The many available edit parameters give you the flexibility to create a vast variety of Performance timbres.

### Entering Performance Mode

Press [PERFORMANCE]. A [▲] mark will appear in the LCD below the word "PERFORMANCE" to indicate that Performance mode is active.

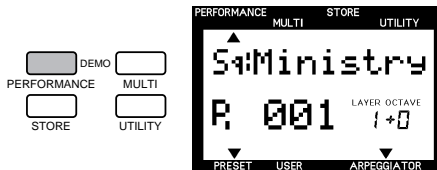

### Performance Play Mode

#### ● Selecting A Bank

There are four banks available: two Preset banks (P1/P2) and two User banks (U1/U2). Each bank contains 128 Performances.

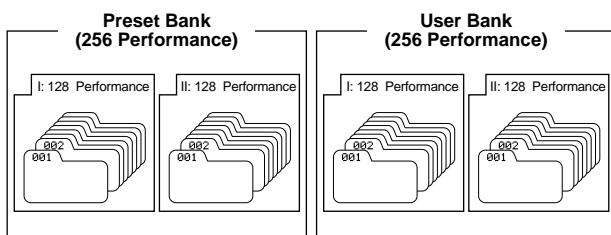

To select the bank you want, press [PRESET] or [USER]. A [▼] mark will appear in the LCD above the word "PRESET" or "USER" to indicate which is selected.

#### PRESET

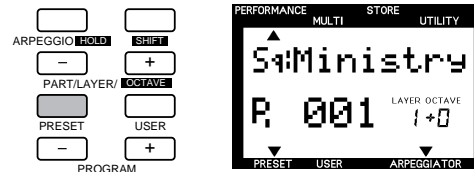

#### USER

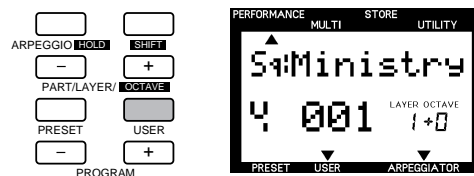

Each time you press [PRESET] or [USER] toggles between P1/P2 and U1/U2 banks, respectively. The currently selected bank will be indicated in the LCD to the left of the Performance number.

#### ● Selecting A Performance

1. Use the NUMERIC KEYPAD (0 ~ 9) to select the Performance number you want.

VWX 7	YZ 8	* & _ 9
MNO 4	PQR 5	STU 6
DEF 1	GHI 2	JKL 3
ABC 0	./, -	SPACE ENTER
	NO/ QUICK PC	YES

**NOTE** For more information about the factory Performances, see the Performance Lists in the separate "Data List" book.



- Press [ENTER] to confirm the number (1 ~ 128). The Performance name and number you have selected will display in the LCD. The Category name will be shown next to the Performance name.

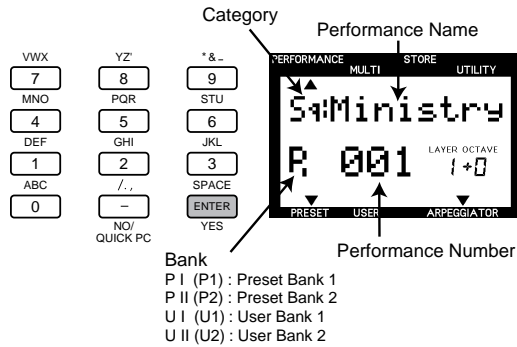

Press PROGRAM [+] to select the next Performance number. Press PROGRAM [-] to select the previous Performance number.

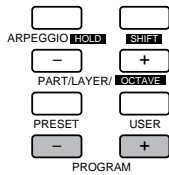

### Quick Program Change

The Quick Program Change function lets you select a specific Performance with the single press of a button, which is especially handy during a live performance. Here's how:

- Press [QUICK PC]. The hundredth and tenth digits of the program number will display in bold to indicate they are "fixed".

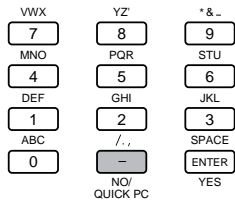

- Press a number (0 ~ 9) in the NUMERIC KEYPAD to select the respective Performance program within the group of ten. To cancel the function, press [QUICK PC] again.

**NOTE** You can also use the Quick Program Change function when selecting the program number for a Part in Multi Play mode (page 57).

## Performance Edit Mode

You can edit any Preset or User Performance to create your own unique Performance by changing the various COMMON and LAYER parameter settings. You can then store your new customized Performance in one of the program memories (1 ~ 128) in either the U1 or U2 User Performance bank.

**NOTE** Changing any parameter in a Performance will automatically engage Performance Edit mode.

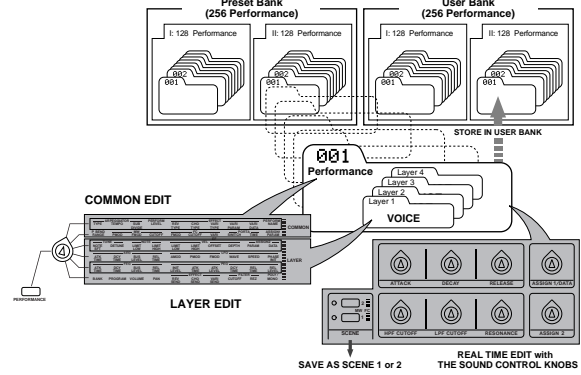

**NOTE** Performance edit parameters are basically divided into two groups: COMMON parameters which apply equally to all the Layer voices, and LAYER parameters which apply to each independent Layer voice.

## Edit Procedure

- Select an Edit menu.  
Turn the EDIT PARAMETER ROTARY switch to choose the Common Edit (1, 2) or Layer Edit (1, 2, 3, 4) menu with the parameter you want to edit.

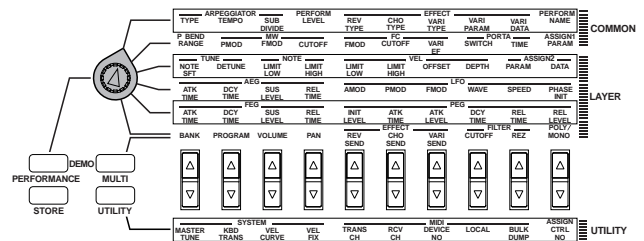

- Select a Layer (if you want to change the Layer parameters).  
Use LAYER [-]/[+] to select the Layer you want to edit.

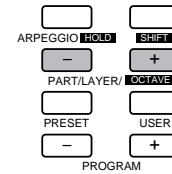

**NOTE** You do not need to select a Layer if you are editing the COMMON parameters, since these are applied equally to all Layers in a Performance.

### 3. Select a parameter.

Press the Parameter Value [UP/DOWN] button corresponding to the parameter you want to edit once to select the parameter and engage Performance Edit mode. The name of the parameter and current settings will display in the LCD.

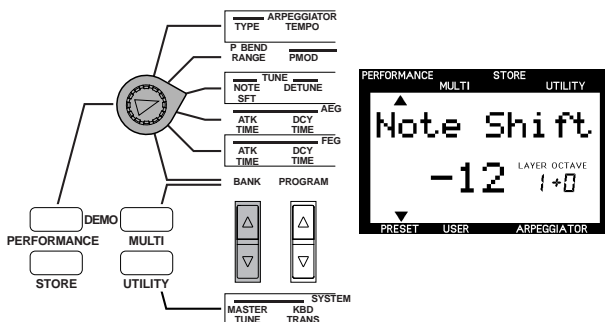

**NOTE** Each voice is preset with optimum settings for the parameters, and the value you set for any parameter will offset (add to or subtract from) the preset value. If the value of a parameter exceeds the maximum or minimum limit available, the highest or lowest value will be used, and any setting beyond that will have no affect.

**NOTE** The actual value of a parameter is the sum of the value displayed in the LCD and the value set by the SOUND CONTROL knob.

**NOTE** The original voice can be restored and heard by returning to Performance Play mode (without storing) and moving the SOUND CONTROL knob to the center position.

**NOTE** You can replace the voices currently assigned to each Layer with different voices or assign a voice to an unused Layer (maximum four Layer voices in a Performance).

### 4. Set the data value or setting.

Press the Parameter Value [UP/DOWN] button again to select a setting. Holding the [UP/DOWN] button scrolls through the settings. The [UP] button increases the value and the [DOWN] button decreases the value.

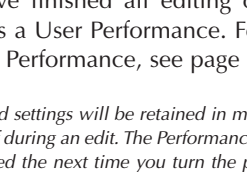
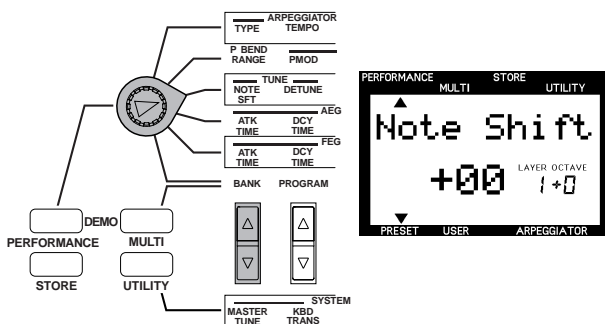

**NOTE** You can also use the NUMERIC KEYPAD (0 ~ 9) and [ENTER] or the ASSIGN 1/DATA knob to change the setting. Precede the number with [-] for negative values.

To change the value for all four Layers at once, hold [SHIFT] and press the [UP/DOWN] button. When you press [SHIFT] in Performance Edit mode, a letter "A" (All) will appear in the LCD below the word "LAYER" to indicate you're changing the values of all Layers.

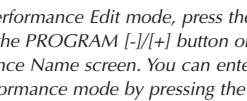
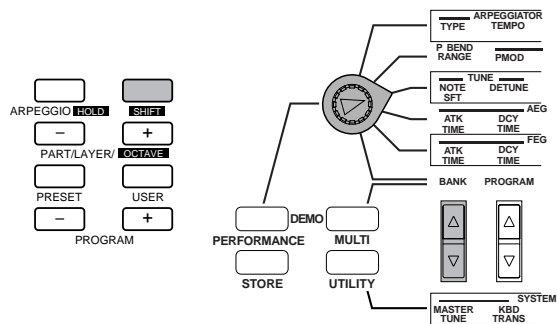

### 5. Set other parameters.

As you press other Parameter Value [UP/DOWN] buttons, the corresponding parameters will appear in the LCD. Set all other parameters to your preference.

### 6. Store the Performance.

When you have finished all editing operations, store the Performance as a User Performance. For details about how to store a User Performance, see page 66.

**NOTE** The edited settings will be retained in memory even if you turn the power off during an edit. The Performance you were editing will still be selected the next time you turn the power on, and you will be able to pick up from where you left off and continue editing the Performance.

**CAUTION** While editing a Performance, if you select another Performance before you have first stored the data as a User Performance, your edited data will be lost. For details about storing a User Performance, see page 66.

**NOTE** To exit Performance Edit mode, press the [PERFORMANCE] button again or the PROGRAM [-]/[+] button once, which will display the Performance Name screen. You can enter Multi Play mode directly from Performance mode by pressing the [MULTI] button.

## Edit Mark

Once you have edited a Performance in any way, the edit mark (a reversed type letter "E") will appear in the LCD between the Performance bank and number. This mark indicates you have edited but not yet stored the Performance.

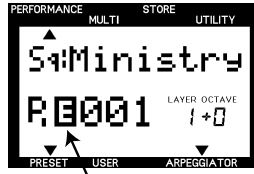

Indicates you have edited, but not stored the Performance.

**NOTE** The edit mark will also appear if you turn a SOUND CONTROL knob.

## Description of Each Edit Function

### Common Edit 1

This menu includes parameters which are common to all Layers in a Performance.

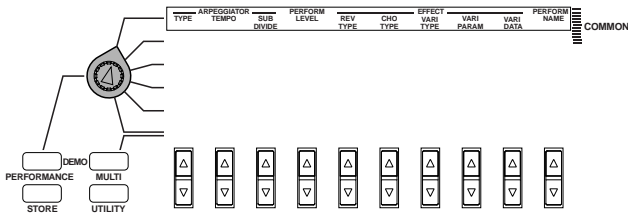

### ARPEGGIATOR

The Arpeggiator automatically creates arpeggiated chords based on the chords and notes you play on the keyboard. There are three Arpeggiator parameters: TYPE, TEMPO and SUBDIVIDE.

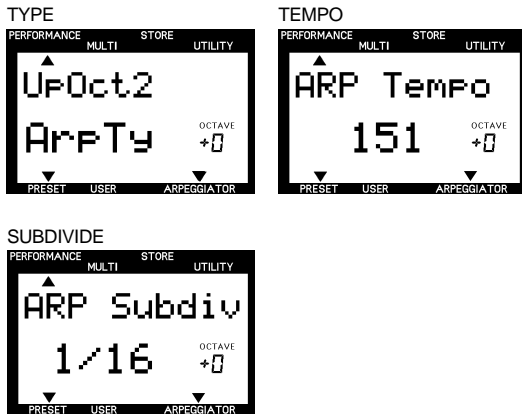

Press the [ARPEGGIO] button to turn the Arpeggiator on. A [▼] mark will appear in the LCD above the word "ARPEGGIATOR" to indicate the Arpeggiator is on.

**NOTE** To turn the Arpeggiator off, press [ARPEGGIO] again.

**TYPE:** Sets the type of arpeggio. You can choose from 40 available types.

**Settings:**

**ArpTy:**

No.	Name	Comments
1	UpOct1	The chord (or phrase) ascends up to 1 Octave.
2	UpOct2	The chord (or phrase) ascends up to 2 Octaves.
3	UpOct4	The chord (or phrase) ascends up to 4 Octaves.
4	DwOct1	The chord (or phrase) descends down to 1 Octave.
5	DwOct2	The chord (or phrase) descends down to 2 Octaves.
6	DwOct4	The chord (or phrase) descends down to 4 Octaves.
7	UpDwAOct1	The chord (or phrase) ascends up to 1 Octave, then descends.
8	UpDwAOct2	The chord (or phrase) ascends up to 2 Octaves, then descends.
9	UpDwAOct4	The chord (or phrase) ascends up to 4 Octaves, then descends.
10	UpDwBOct1	The chord (or phrase) ascends up to 1 Octave, then descends. (This feature is slightly different from type UpDwAOct1.)
11	UpDwBOct2	The chord (or phrase) ascends up to 2 Octaves, then descends. (This feature is slightly different from type UpDwAOct2.)
12	UpDwBOct4	The chord (or phrase) ascends up to 4 Octaves, then descends. (This feature is slightly different from type UpDwAOct4.)
13	RandmOct1	Plays up and down randomly between 1 Octave, based on the chord you play.
14	RandmOct2	Plays up and down randomly between 2 Octaves, based on the chord you play.
15	RandmOct4	Plays up and down randomly between 4 Octaves, based on the chord you play.
16	Techno-A	Typical techno sequence TYPE A. (Euro techno type.)
17	Techno-B	Typical techno sequence TYPE B. (UK Type with Velocity.)
18	Techno-C	Typical techno sequence TYPE C. (Japan techno type.)
19	Techno-D	Typical techno sequence TYPE D. (German techno type.)
20	DAHouse	Backing sequence with House music feel. (Bass for left hand, Chord play for right hand.)
21	SyncopaA	Syncopation type sequence TYPE A.
22	SyncopaB	Syncopation type sequence TYPE B. (Octave moves extremely.)
23	Echo&Pan	Moving panning sequence with echo.
24	TekkEcho	Moving filter sequence with echo.
25	SweepLine	Sweeping filter sequence.
26	PulseLine	The sequence mixed with bass line and sequence line.
27	BaseLineA	Arpeggio phrase TYPE A for bass.
28	BaseLineB	Arpeggio phrase TYPE B for bass. (With Velocity.)
29	BaseLineC	Arpeggio phrase TYPE C for bass.
30	BaseLineD	Arpeggio phrase TYPE D for bass.
31	Ocean	Duophonic Arpeggio, nice for textures, uses up to 4 input notes.
32	X-Sweep	Duophonic Arpeggio, two arpeggios moving in opposite directions, using up to 3 input notes.
33	Lamb	Duophonic Arpeggio, nice with complex chords, using up to 5 input notes.
34	Thips	Note Repetition Pattern, with velocities, using up to 2 input notes.
35	HardCore	Monophonic Acid Line, using up to 3 input notes.
36	Doves	Trancey Monophonic Line, using up to 4 input notes.
37	Chordal	Duophonic Chordal Sweep, using up to 3 input notes.
38	Orbit	Triphonic Chordal Movement, using up to 6 input notes, try different chords in each hand.
39	VelGruv	Monophonic Acid Line, with velocities, using up to 4 input notes.
40	MuteLine	Monophonic Sequence, very short notes, using up to 2 input notes.

## ARPEGGIATOR HOLD

The ARPEGGIATOR HOLD function lets you play a chord to start the automatic arpeggio then take your hand off the keyboard and have the arpeggiated chord play continuously in a loop. Play another chord and the automatic arpeggios will change accordingly.

Here's how to activate the ARPEGGIATOR HOLD function:

1. Hold [SHIFT] and press [ARPEGGIO]. The Arpeggiator [▼] mark in the LCD will start blinking to indicate the function is active.
2. Play a series of chords or notes.
3. To stop the arpeggiated chords, press [ARPEGGIO] again.

## ARPEGGIATOR SPLIT

If you hold [SHIFT] and press the TYPE Parameter Value [UP] button when the TYPE parameter is displayed in the LCD, the ARPEGGIATOR SPLIT function will be enabled. A reversed type letter "S" will appear to the right of the TYPE name to indicate the function is active.

The ARPEGGIATOR SPLIT function divides the keyboard at C3 (indicated by the [▼] mark printed above the keyboard) and lets you play the arpeggiated chords on the lower half of the keyboard (below C3) and play normal chords and notes on the upper half (C3 and above). To cancel the function, hold [SHIFT] and press the TYPE Parameter Value [DOWN] button.

**TEMPO:** Sets the tempo of the Arpeggiator in beats per minute or to be controlled by an external MIDI clock.

### Settings:

ARP Tempo: MIDI, 40 ~ 240 (beats per minute)

**NOTE** If you want to synchronize the tempo of the Arpeggiator with the tempo of an external MIDI device, set the TEMPO parameter to MIDI.

**SUBDIVIDE:** Determines the basic note timing resolution settings of the Arpeggiator.

### Settings:

ARP Subdiv: 3/8= ♩, 1/4= ♩, 3/16= ♩, 1/6= ♩, 1/8= ♩, 3/32= ♩, 1/12= ♩, 1/16= ♩, 1/24= ♩, 1/32= ♩

**NOTE** Arpeggiator data can be output as MIDI messages.

**NOTE** The Arpeggiator data is normally output as MIDI messages from the MIDI OUT terminal. You can cancel MIDI data output by holding the [ARPEGGIO] button when switching on the power.

## PERFORM LEVEL (Performance Level)

This determines the volume level of the Performance.



### Settings:

Perf Level: 0 ~ 127

## EFFECT

There are five effect parameters: REV TYPE (Reverb Type), CHO TYPE (Chorus Type), VARI TYPE (Variation Type), VARI PARAM (Variation Parameter) and VARI DATA (Variation Data). For information about the three digital effects units, see page 70.

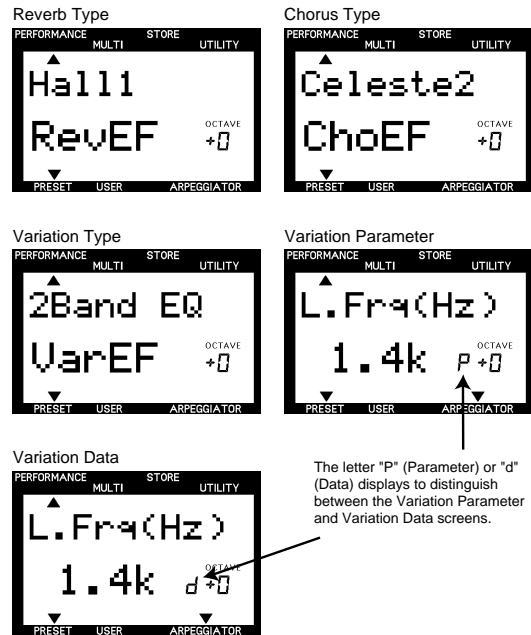

The letter "P" (Parameter) or "d" (Data) displays to distinguish between the Variation Parameter and Variation Data screens.

**REV TYPE (Reverb Type):** Determines the type of Reverb effect. You can choose from 12 types. (See the Effect Type List in the separate "Data List" book.)

**CHO TYPE (Chorus Type):** Determines the type of Chorus effect. You can choose from 14 types. (See the Effect Type List in the separate "Data List" book.)

**VARI TYPE (Variation Type):** Determines the type of Variation effect. You can choose from 62 types. (See the Effect Type List in the separate "Data List" book.)

**VARI PARAM (Variation Parameter):** Determines the Variation effect parameters. Available parameters depend on the VARI TYPE setting.

**NOTE** If VARI TYPE is set to "Effect Off", those Layers with VARI SEND set to "on" (page 55) will not sound. When you don't want to apply the Variation Effect to the Layers, set VARI TYPE to "Thru".

**NOTE** The Variation effect works as an Insertion effect in Performance mode. (For more information, see page 70.)

For more information about each Variation effect parameter, see the Effect Parameter List in the separate "Data List" book.



## ■ MW (Modulation Wheel)

This sets the control parameters of the MODULATION wheel. There are three parameters: PMod (Pitch Modulation), FMod (Filter Modulation) and CUTOFF (Cutoff). The parameters set here can be controlled with the MODULATION wheel to add vibrato or wah-wah type effects to the sound.

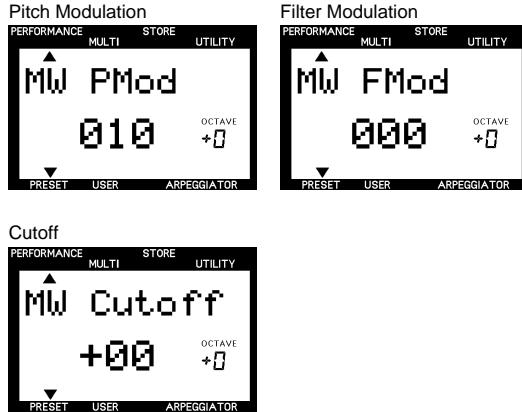

**PMod (Pitch Modulation):** Sets the pitch modulation depth created by the LFO (Low Frequency Oscillator). The value set here will determine the range of the pitch modulation controlled by the MODULATION wheel. Moving the MODULATION wheel forward will increase the depth of the pitch modulation, while moving it back will decrease the depth.

**FMod (Filter Modulation):** Sets the Low Pass Filter modulation depth created by the LFO (Low Frequency Oscillator). The value set here will determine the range of the filter modulation controlled by the MODULATION wheel. Moving the MODULATION wheel forward will increase the depth of the filter modulation, while moving it back will decrease the depth.

**CUTOFF:** Sets the range of the Low Pass Filter cutoff frequency points above which the other frequencies are cut off. The value set here will determine the range of the cutoff frequency points when using the MODULATION wheel. Moving the MODULATION wheel forward will raise the cutoff frequency point (and make the tone brighter), while moving it back will lower the cutoff point (and make the tone darker).

### Settings:

MW PMod: 0 ~ 127  
MW Fmod: 0 ~ 127  
MW Cutoff: -64 ~ +63

## ■ FC (Foot Control)

This sets the parameters controlled by a Foot Controller connected to the FOOT CONTROLLER jack on the rear panel. There are three parameters: FMod (Filter Modulation), CUTOFF, and VARI EF (Variation Effect).

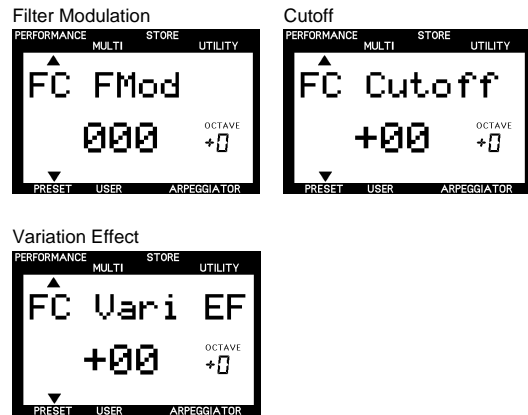

**FMOD (Filter Modulation):** Sets the Low Pass Filter modulation depth created by the LFO (Low Frequency Oscillator). The value set here will determine the range of the filter modulation controlled by the Foot Controller. Pressing the Foot Controller towards maximum position will increase the depth of the filter modulation.

**CUTOFF:** Sets the range of the Low Pass Filter cutoff frequency points above which other frequencies are cut off. The value set here will determine the range of the cutoff frequency points controlled by the Foot Controller. Pressing the Foot Controller towards maximum position will raise the cutoff frequency point (and make the voice brighter).

**VARI EF (Variation Effect):** Determines the Variation effect range set by the COMMON EFFECT parameters (page 44) controlled by the Foot Controller.

**NOTE** For details about which parameters the Foot Controller can control, see the Effect Parameter List in the separate "Data List" book.

### Settings:

FC FMod: 0~127  
FC Cutoff: -64 ~ +63  
FC Vari EF: -64 ~ +63

## ■ PORTA (Portamento)

This determines the Portamento settings for the Layer voices. Portamento continuously changes the pitch from one note to the next, thus letting you glide the pitch from note to note. There are two parameters, SWITCH and TIME. SWITCH values can be set for each individual Layer, and TIME values apply to all Layers equally.

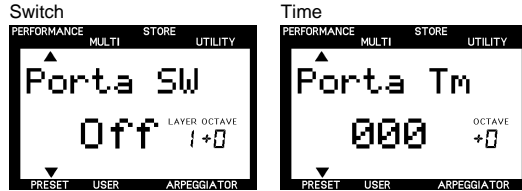

**SWITCH:** Turns the Portamento on or off (for each Layer).

**TIME:** Sets the time it takes for the pitch to reach the next note played (for all Layers).

### Settings:

**Porta SW:** on, off

**Porta Tm:** 0 ~ 127

## ■ ASSIGN1 PARAM (ASSIGN1 Parameter)

This determines which parameter will be controlled by the ASSIGN 1/DATA knob. You can choose from 29 types of available parameters. (The default parameter assigned to the ASSIGN 1/DATA knob depends on the Performance selected.)



### Settings:

(For details about each parameter, see the Reference pages as listed in the table below.)

NO.	LCD
0	off
1	PerfLevel (Performance Level) (page 44)
2	ArpgTempo (Arpeggiator Tempo) (page 44)
3	ArpgType (Arpeggiator Type) (page 43)
4	ArpgSubdiv (Arpeggiator Subdivide) (page 44)
5	MWCutoff (MW Cutoff) (page 46)
6	MWPMODpth (MW Pitch Modulation Depth) (page 46)
7	MWFModDpth (MW Filter Modulation Depth) (page 46)
8	PBRRange (Pitch Bend Range) (page 45)
9	FCCutoff (FC Cutoff) (page 46)
10	FCFModDpth (FC Filter Modulation Depth) (page 46)
11	FCVARIpth (FC Variation Depth) (page 46)
12	PortaTime (Portamento Time) (page 47)
13	*FEGDcyTime (FEG Decay Time) (page 53)
14	*AEGDcyTime (AEG Decay Time) (page 50)
15	*ChoToRev (Chorus Send To Reverb)
16	*VariCntrl (Variation Control)
17	*RevChoSend (Reverb And Chorus Send)
18	*ChorusSend (Chorus Send) (page 55)
19	*ReverbSend (Reverb Send) (page 55)
20	*Pan (page 54)
21	*LFOSpeed (LFO Speed) (page 51)
22	*LFOPMod (Vibrato Depth) (page 51)
23	*VibDelay (Vibrato Delay)
24	*LFOAMod (LFO Amplitude Modulation Depth) (page 51)
25	*LFOFMod (LFO Filter Modulation Depth) (page 51)
26	*FEGAtkTime (FEG Attack Time) (page 53)
27	*FEGSusLvl (FEG Sustain Level) (page 53)
28	*FEGVelSens (FEG Level Velocity Sensitivity)
29	*Pitch (Oscillator Pitch)

Parameters marked with an asterisk (\*) affect all Layer voices equally in a Performance. Although you cannot directly edit them from the LCD, you can assign them to the ASSIGN 1/DATA knob.

You can also select each parameter by inputting the corresponding number using the NUMERIC KEYPAD (0 ~ 9) and [ENTER].

## Layer Edit 1

The functions in this menu are mainly related to the keyboard. The parameters can be set for each individual Layer in a Performance.

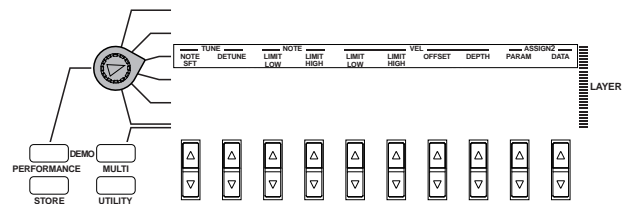

## TUNE

This sets the tuning of the selected Layer. There are two parameters: NOTE SFT (Note Shift) and DETUNE.

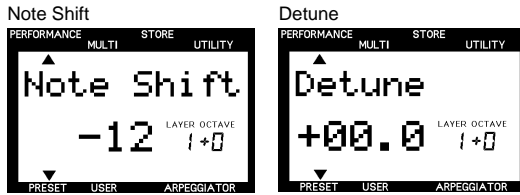

**NOTE SFT (Note Shift):** Raises or lowers the pitch of the voice in semitones.

### Settings:

**Note Shift:** -24 ~ +24 (semitones)

**DETUNE:** Raises or lowers the pitch of the voice in fine increments or decrements of 0.1 Hz each.

### Settings:

**Detune:** -12.8 Hz ~ +12.7 Hz

## NOTE

This sets the range of notes that each individual Layer voice will play. There are two parameters: LIMIT LOW and LIMIT HIGH.

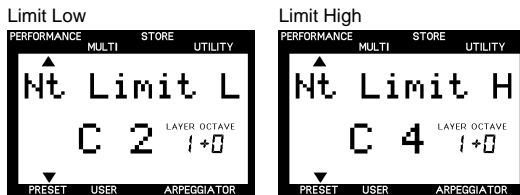

**LIMIT LOW:** Determines the low note limit, or the lowest note that will be played by the voice.

**LIMIT HIGH:** Determines the high note limit, or the highest note that will be played by the voice.

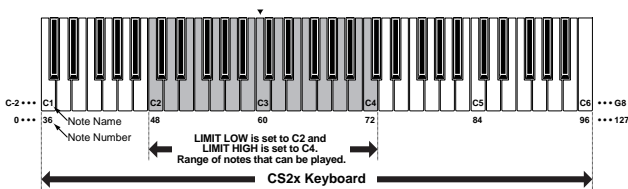

### Settings:

**Nt Limit L:** C-2 ~ G8

**Nt Limit H:** C-2 ~ G8

**NOTE** You cannot set the LIMIT LOW note above the LIMIT HIGH note, or the LIMIT HIGH note below the LIMIT LOW note.

## VEL (Velocity)

This determines the velocity settings for each Layer voice. There are four parameters: LIMIT LOW, LIMIT HIGH, OFFSET and DEPTH.

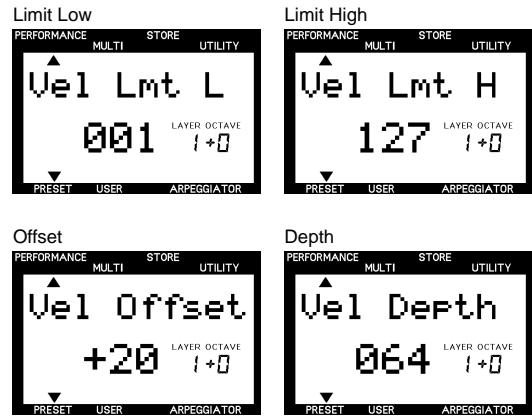

**LIMIT LOW:** Determines the lowest velocity value that will be detected when the keyboard is played. No sound will be produced if the keyboard is played with a velocity value weaker than the one set here.

**LIMIT HIGH:** Determines the highest velocity value that will be detected when the keyboard is played. No sound will be produced if the keyboard is played with a velocity value stronger than the one set here.

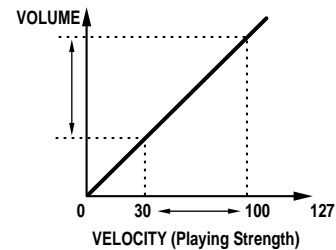

When LIMIT LOW is set to "30" and LIMIT HIGH is set to "100" the velocity range that can be played is limited as shown in the above graph.

### Settings:

**Vel Lmt L:** 1 ~ 127

**Vel Lmt H:** 1 ~ 127

**NOTE** You cannot set the LIMIT LOW velocity above the LIMIT HIGH velocity, or the LIMIT HIGH velocity below the LIMIT LOW velocity.



**OFFSET:** Sets the offset value of the velocity. The value set here will be added to or subtracted from the actual velocity value.

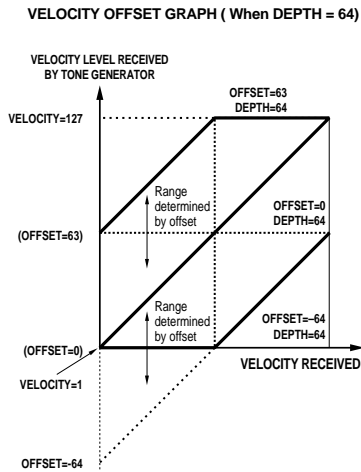

**Settings:**

Vel Offset: -64 ~ +63

**DEPTH:** Sets the depth of the velocity. The larger the value, the more sensitive the velocity will be, and playing the keyboard will produce louder sounds.

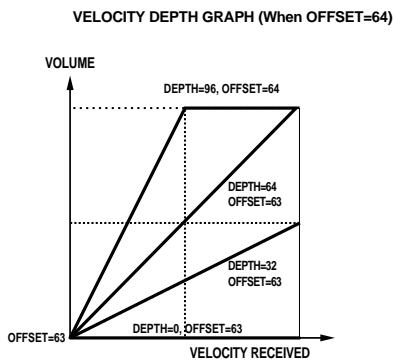

**Settings:**

Vel Depth: 0 ~ 127

**■ ASSIGN2**

This sets the control parameter and knob sensitivity of the ASSIGN 2 knob. You can assign up to four parameters from 29 types. You can also set the sensitivity (control range of the knob) for each parameter. (The default parameter assigned to the ASSIGN 2 knob depends on the Performance selected.)

**1. Select the Layer.**

Press LAYER [-]/[+] to select the Layer to which you want to assign a parameter.

**2. Select the item (parameter type or sensitivity) you want to edit and the assignment number which you want to assign the parameter to.**

Press PARAM [UP] to select the item (parameter type or sensitivity) you want to edit, and the assignment number. Each time you press PARAM [UP] the arrow cursor will move as shown in the following table.

	▲	▼
Parameter type of assignment number 1	↓	↑
Sensitivity of assignment number 1	↓	↑
Parameter type of assignment number 2	↓	↑
Sensitivity of assignment number 2	↓	↑
Parameter type of assignment number 3	↓	↑
Sensitivity of assignment number 3	↓	↑
Parameter type of assignment number 4	↓	↑
Sensitivity of assignment number 4	↓	↑

Each time you press PARAM [DOWN] the arrow cursor will move in the opposite direction.

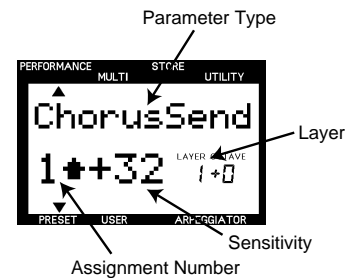

**3. Move the cursor to the Parameter Type area in the LCD and press DATA [UP/DOWN] to select the parameter type.**

**Settings:**

The parameters listed in the following table can be assigned to assignment number 1 ~ 4. For details about each parameter, see the Reference pages as listed in the table.

**NOTE** When voices are not assigned to the Layers (BANK="off"), Parameter type and sensitivity will not display.

NO.	LCD
0	off
1	Volume (page 54)
2	NoteShift (page 48)
3	Detune (page 48)
4	Pan (page 54)
5	ChorusSend (page 55)
6	ReverbSend (page 55)
7	*Pitch (Oscillator Pitch)
8	VelSnsDpth (Velocity Sensitivity Depth) (page 49)
9	VelSnsOfst (Velocity Sensitivity Offset) (page 49)
10	Cutoff (Filter Cutoff Frequency) (page 55)
11	Resonance (page 55)
12	AEGAtkTime (AEG Attack Time) (page 50)
13	AEGDcyTime (AEG Decay Time) (page 50)
14	AEGSusLvl (AEG Sustain Level) (page 50)
15	AEGRelTime (AEG Release Time) (page 51)
16	LFOSpeed (LFO Speed) (page 51)
17	LFOAMod (LFO Amplitude Modulation Depth) (page 51)
18	LFOPMOD (LFO Pitch Modulation Depth) (page 51)
19	LFOFMod (LFO Filter Modulation Depth) (page 51)
20	FEGAtkTime (FEG Attack Time) (page 53)
21	FEGDcyTime (FEG Decay Time) (page 53)
22	FEGSusLvl (FEG Sustain Level) (page 53)
23	FEGRelTime (FEG Release Time) (page 53)
24	PEGInltLvl (PEG Initial Level) (page 53)
25	PEGAtkTime (PEG Attack Time) (page 53)
26	PEGAtkLvl (PEG Attack Level) (page 53)
27	PEGDcyTime (PEG Decay Time) (page 53)
28	PEGRelTime (PEG Release Time) (page 53)
29	PEGRelLvl (PEG Release Level) (page 53)

Although parameters marked with an asterisk (\*) cannot be modified, you can assign them to the ASSIGN 2 knob.

You can also select each parameter by inputting the corresponding number using the NUMERIC KEYPAD (0 ~ 9) and [ENTER].

4. Press PARAM [UP/DOWN] to move the arrow cursor to the Sensitivity area in the LCD.

5. Press DATA [UP/DOWN] to set the knob sensitivity.

**Settings:**

Parameters can be set between -32 and +32 for assignment numbers 1 through 4.

**NOTE** As an example, say you have selected the Volume parameter and set the knob sensitivity to the positive value "+32". The volume is "0" when the knob is turned counter-clockwise to the far left, and "127" when the knob is turned clockwise to the far right. If the knob sensitivity is set to the negative value "-32" the volume is "127" when the knob is turned to the far left and "0" when the knob is turned to the far right. If the sensitivity value is low, the control range of the knob will be narrowed and limited.

6. Repeat the above steps to set a different Parameter Type and knob Sensitivity value to each of the four assignment numbers.

**NOTE** When the PARAM screen is displayed, you can select the Parameter Type or change the knob Sensitivity using the ASSIGN 1/DATA knob or the NUMERIC KEYPAD (0 ~ 9) and [ENTER].

## Layer Edit 2

The functions in this menu include AEG (Amplitude Envelope Generator) and LFO (Low Frequency Oscillator) parameters, which are essential for creating each Layer voice. The parameters can be set for each individual Layer in a Performance.

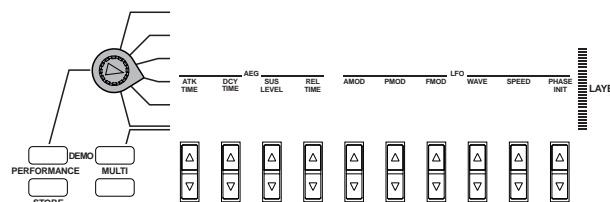

### AEG (Amplitude Envelope Generator)

This sets the parameters for the Amplitude Envelope Generator. The AEG lets you shape how the volume level of each Layer voice changes over time, from when a key is struck, then released, and how the sound decays. There are four parameters: ATK TIME (Attack Time), DCY TIME (Decay Time), SUS LEVEL (Sustain Level) and REL TIME (Release Time).

**NOTE** Each musical instrument has a unique envelope curve which plays an important role in determining its sound characteristics. The AEG simulates the change of the volume envelope curve over time.



**NOTE** Depending on the voice selected, changing certain parameters may not produce a noticeable effect.

**ATK TIME (Attack Time):** Determines the time required for a sound to reach its maximum volume level when a note is played.

**DCY TIME (Decay Time):** Determines the time required for a sound to reach its Sustain Level from a maximum volume level while the key is held.

**SUS LEVEL (Sustain Level):** Sets the Sustain Level. The volume will be maintained at this level for as long as the key is held.

**REL TIME (Release Time):** Determines the time it takes for a sound to sustain after the key is released.

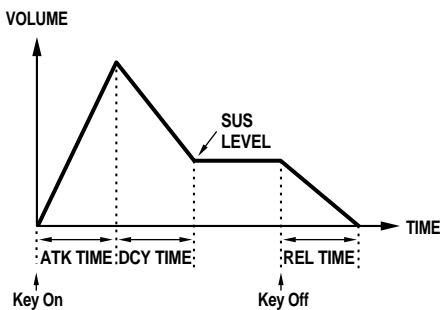

**Settings:**

- AEG Atk Tm: -63 ~ +63
- AEG Dcy Tm: -63 ~ +63
- AEG Sus Lv: -64 ~ +63
- AEG Rel Tm: -63 ~ +63

**LFO (Low Frequency Oscillator)**

This sets the parameters for the Low Frequency Oscillator for each Layer voice. The LFO is an oscillator that generates low frequency signals (below hearing range) which are used to modulate certain aspects of the sound such as pitch, volume or filter level. There are six parameters: AMOD (Amplitude Modulation), PMOD (Pitch Modulation), FMOD (Filter Modulation), WAVE, SPEED and PHASE INIT (Phase Initialize).

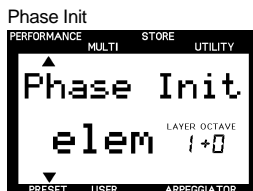
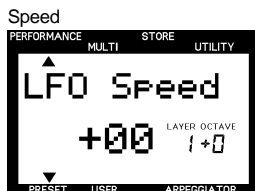
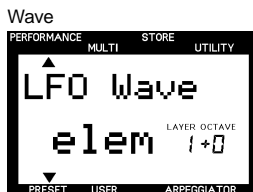
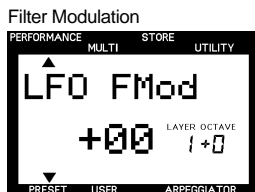
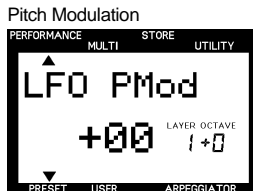
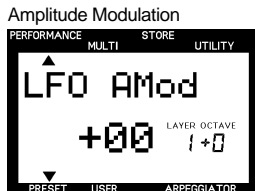

**AMOD (Amplitude Modulation):** Adds a cyclical change to the volume level by applying LFO frequency modulations to create a tremolo effect. Higher values widen the range of the volume change.

**PMOD (Pitch Modulation):** Adds a cyclical change to the pitch by applying LFO frequency modulations to create a vibrato effect. Higher values widen the range of the pitch change.

**FMOD (Filter Modulation):** Adds a cyclical change to the Low Pass Filter cutoff frequency by applying LFO frequency modulations to create wah-wah type effects. Higher values widen the range of cutoff frequency change.

**WAVE:** Selects the LFO frequency signal used for modulation. You can select from the following types:

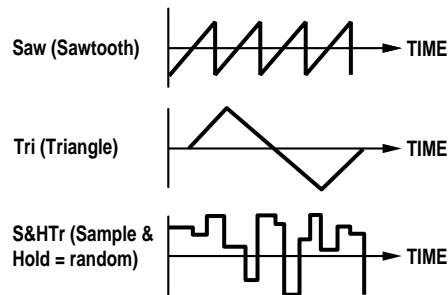

\*S&HTr = Adds random changes to the pitch.  
(NOTE: Triangle waves will be applied for the AMOD and FMOD. Triangle wave is applied even if you select S&HTr for PMOD, when controlling the PMOD with the Modulation Wheel.)

**ELEM (Element)**

\*Default settings of each element depending on the selected voice.

**SPEED:** Sets the speed of the LFO frequency modulation. Higher values increase the speed.

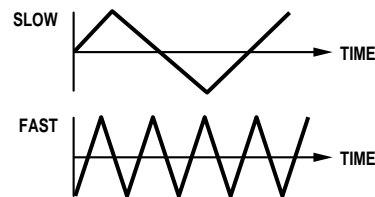

**PHASE INIT (Phase Initialize):** Determines if the phase of the LFO frequency modulation wave is reset or not each time a note is played. There are three types: Free, Retr (Retrigger) and Elem (Element).

**Free:** The wave starts at the phase position where a note is played.

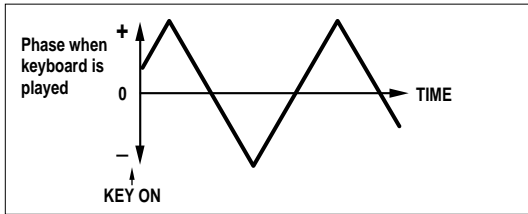

**Retr (Retrigger):** The wave starts at +/-0 phase position.

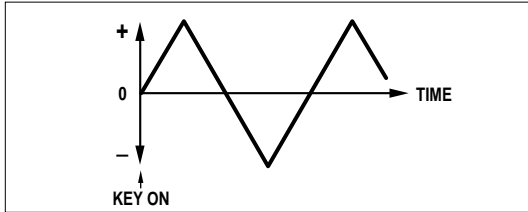

**Elem (Element):** The wave starts from the default phase position (Free or Retr) for each element of the voices.

**Settings:**

- LFO AMod: -31 ~ +31
- LFO PMod: -63 ~ +63
- LFO FMod: -15 ~ +15
- LFO Wave: Saw, Tri, S&HTr, Elem
- LFO Speed: -63 ~ +63
- Phase Init: Free, Retr, Elem

**Layer Edit 3**

The functions in this menu include FEG (Filter Envelope Generator) and PEG (Pitch Envelope Generator) parameters, which are essential for creating each Layer voice. The parameters can be set for each individual Layer in a Performance.

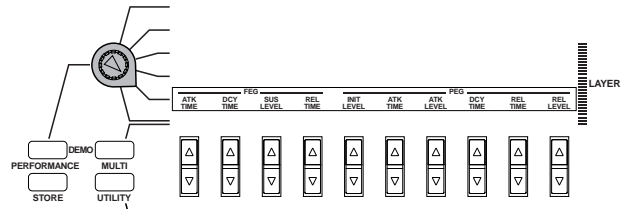

**FEG (Filter Envelope Generator)**

This sets the parameters for the Filter Envelope Generator. The FEG lets you shape how the tone, or timbre, of each Layer voice changes over time, from when a key is hit, then released, and how the sound decays. There are four parameters: ATK TIME (Attack Time), DCY TIME (Decay Time), SUS LEVEL (Sustain Level) and REL TIME (Release Time). These parameters affect Low Pass Filter (LPF) only.

**NOTE** Depending on the voice selected, changing certain parameters may not produce a noticeable effect.

Four screenshots of the FEG parameter adjustment screens. Each screen shows the parameter name, the current value, and the layer/octave. The screens are:
 

- Attack Time:** FEG Atk Tm, value +00, LAYER OCTAVE 1+0.
- Decay Time:** FEG Dcy Tm, value +00, LAYER OCTAVE 1+0.
- Sustain Level:** FEG Sus Lv, value +00, LAYER OCTAVE 1+0.
- Release Time:** FEG Rel Tm, value +00, LAYER OCTAVE 1+0.

 Each screen has navigation buttons: PERFORMANCE, MULTI, STORE, UTILITY, PRESET, USER, and ARPEGGIATOR.

**ATK TIME (Attack Time):** Determines the time required for a sound to reach its maximum cutoff frequency level when a note is played.

**DCY TIME (Decay Time):** Determines the time required for a sound to reach its Sustain Level from a maximum level while the key is held.

**SUS LEVEL (Sustain Level):** Sets the Sustain Level. The cutoff frequency will be maintained at this level for as long as the key is held.

**REL TIME (Release Time):** Determines the time it takes for the cutoff frequency to reach the level preset for each voice after the key has been released.

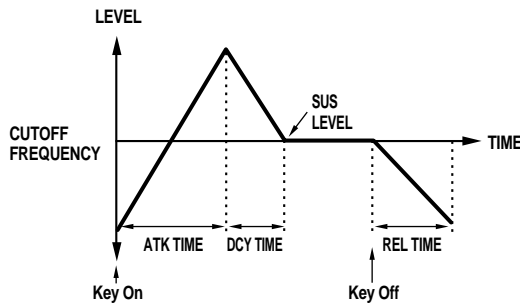

**Settings:**

- FEG Atk Tm: -63 ~ +63
- FEG Dcy Tm: -63 ~ +63
- FEG Sus Lv: -64 ~ +63
- FEG Rel Tm: -63 ~ +63

**■ PEG (Pitch Envelope Generator)**

This sets the parameters for the Pitch Envelope Generator. The PEG lets you shape how the pitch of each Layer voice changes over time, from when a key is struck, then released, and how the sound decays. There are six parameters: INIT LEVEL (Initial Level), ATK TIME (Attack Time), ATK LEVEL (Attack Level), DCY TIME (Decay Time), REL TIME (Release Time) and REL LEVEL (Release Level).

**NOTE** Since the PEG simulates the change of the pitch envelope curve over time, you can create everything from SFX type effects to the subtle pitch changes of a wind instrument.

**NOTE** Depending on the voice selected, changing certain parameters may not produce a noticeable effect.



**INIT LEVEL (Initial Level):** Sets the initial pitch level when a key is played.

**ATK TIME (Attack Time):** Determines the time required for a sound to reach its Attack Level after a note is played.

**ATK LEVEL (Attack Level):** Sets the initially targeted level after a note is played.

**DCY TIME (Decay Time):** Determines the time required for a sound to reach its basic pitch from the Attack Level while the key is held.

**REL TIME (Release Time):** Determines the time it takes for the basic pitch to reach the Release Level after the key has been released.

**REL LEVEL (Release Level):** Sets the last targeted level after the key is released.

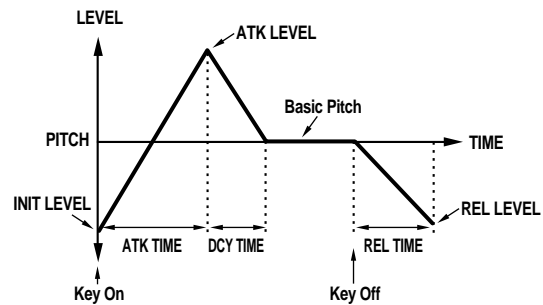

**Settings:**

- PEG Init: -64 ~ +63
- PEG Atk Tm: -63 ~ +63
- PEG Atk Lv: -64 ~ +63
- PEG Dcy Tm: -63 ~ +63
- PEG Rel Tm: -63 ~ +63
- PEG Rel Lv: -64 ~ +63

## Layer Edit 4

The functions in this menu include parameters which determine voice assignment, volume and panning settings for each Layer, plus effect levels, filter settings and more. The parameters can be set for each individual Layer in a Performance.

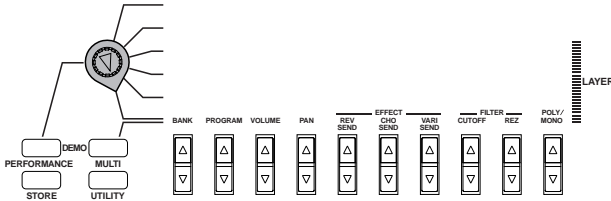

### BANK

This lets you select an XG or a PRE Bank of available voices which can be assigned to the individual Layers (also see PROGRAM, below).



#### Settings:

**Bank:** off, XG000, 001, 003, 006, 008, 012, 014, 016 ~ 020, 024 ~ 028, 032 ~ 043, 045, 064 ~ 073, 096 ~ 101, SFX, PRE0 ~ 20 ("PRE" banks are for Performances only)

Bank Conversion Table for Voices Used in Performances

MSB	LSB	Bank	LCD	Remarks
0	0	0	XG000	XG
0	1	1	XG001	↓
↓	↓	↓	↓	↓
0	101	101	XG101	↓
64	0	102	SFX	↓
63	0	103	PRE0	for Performance
63	1	104	PRE1	↓
↓	↓	↓	↓	↓
63	7	110	PRE7	↓
63	8	111	PRE8	↓
↓	↓	↓	↓	↓
63	20	123	PRE20	for Performance
-	-	999	off	

A bank can be selected directly by inputting the corresponding BANK number using the NUMERIC KEYPAD (0 ~ 9) and [ENTER].

**NOTE** For more information about Banks and Programs (voices), see the Voice List in the separate "Data List" book.

### PROGRAM

This lets you select a voice, or program, from the currently selected BANK.



#### Settings:

**(Name):** #001 ~ #128

**NOTE** Note that the Program numbers available are 1 ~ 128 and the MIDI Program Change numbers range from 0 ~ 127. To match the MIDI Program Change number when switching programs using an external MIDI device, subtract a value of "1" from the CS2x Program number you want the MIDI message to select.

**NOTE** For more information about Banks and Programs (voices), see the Voice Lists in the separate "Data List" book.

### VOLUME

This sets the volume level of each individual Layer.

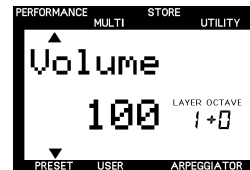

#### Settings:

**Volume:** 0 ~ 127

### PAN

This sets the panning position (the left or right placement in the stereo spectrum) of each individual Layer. Since different pan positions can be set for each Layer, you can create a sophisticated stereo image (for stereo output) for the Performance.

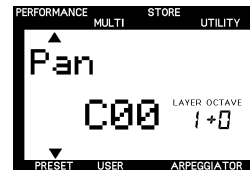

#### Settings:

**Pan:** Random, L63 (far left position) ~ L01, C00 (center position), R01 ~ R63 (far right position)

**NOTE** When set to "Random", the pan position of each Layer will alternate between left and right as you play the Performance.

**NOTE** Some of the voices are preset and have a fixed panning of "left" in the lower register and "right" in the higher register. In such a case you cannot modify the pan setting.

## EFFECT

This determines the Reverb and Chorus effect levels of each Layer as well as the Variation effect configuration. There are three parameters: REV SEND (Reverb Send level), CHO SEND (Chorus Send level) and VARI SEND (Variation Send on/off).

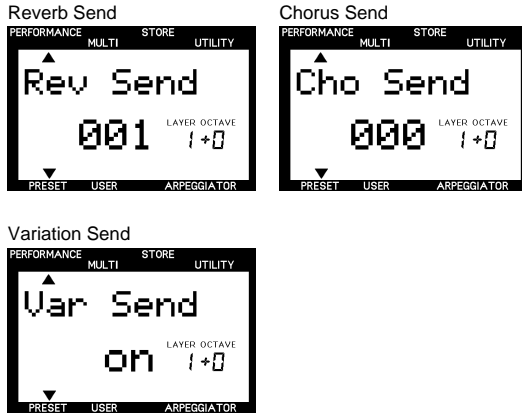

**REV SEND (Reverb Send):** Determines the send level of the Reverb effect.

**CHO SEND (Chorus Send):** Determines the send level of the Chorus effect.

**VARI SEND (Variation Send):** Enables or disables the output of the Variation effect.

### Settings:

Rev Send: 0 ~ 127  
 Cho Send: 0 ~ 127  
 Var Send: off, on

**NOTE** The value of some Layers may forcibly be changed when using the Variation effect.

**NOTE** For more information about the digital effects, see page 70.

## FILTER

This sets the filter parameters for each Layer. There are two parameters: CUTOFF and REZ (Resonance). These parameters affect Low Pass Filter (LPF) only.

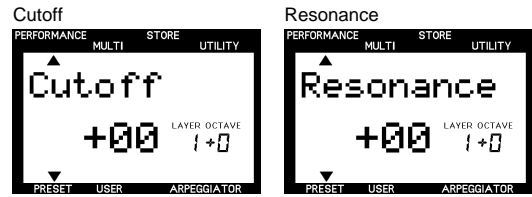

**NOTE** Generally filters change the timbre by passing signals within a specific frequency bandwidth and cutting others. The CS2x features two types of filters. A Low Pass Filter (LPF) passes signals below the specified frequency point (the "cutoff frequency") and cuts off the signals above it. A High Pass Filter (HPF) passes the signals above the cutoff frequency and cuts off the signals below it. The HPF can be controlled by SOUND CONTROL Knob 5 (page 19).

**NOTE** Depending on the voice selected, changing certain parameters may not produce a noticeable effect.

**CUTOFF:** Determines the cutoff frequency of the filter, or the frequency point above which other frequencies are cut off or filtered out. Higher settings result in brighter tones and lower settings result in darker tones.

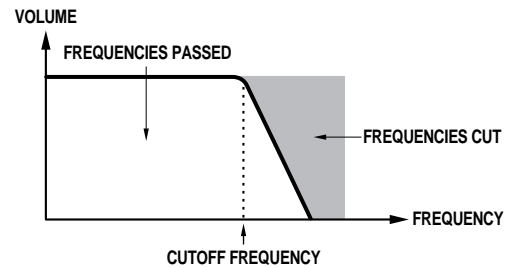

**REZ (Resonance):** Sets the amount of filter resonance or emphasis around the cutoff frequency. Higher settings produce a higher resonant peak, while lower settings produce a relatively flat response.

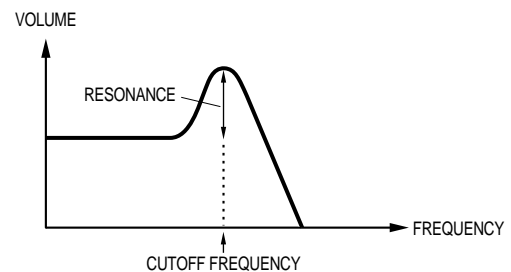

### Settings:

Cutoff: -64 ~ +63  
 Resonance: -64 ~ +63

## ■ POLY/MONO

This determines whether the voice in each Layer is played monophonically (only one note at a time) or polyphonically (up to a maximum 64 notes at a time).

Generally Polyphonic mode is selected to generate multiple sounds at one time. There are cases, however, where it is more effective to select Monophonic mode, such as when using a bass sound, brass sound, or an analog synthesizer lead sound.

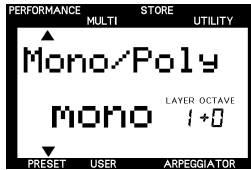

### Settings:

**Mono/Poly:** mono, poly

**NOTE** You can play up to 64 notes at a time. However, the number of notes may be reduced or truncated if you use voices which consist of two Layers and/or play a rather complicated song which uses too many notes.

## Multi Play In Performance Mode

- In Performance mode you can use the Performance as one instrument Part plus 12 additional Parts for multitimbral play using an external MIDI sequencer. The Layer (using between 1 and 4 voices) makes up Part 1 and the additional 12 Parts available correspond to Parts 5 ~ 16.

Though the receive channels are set at the factory as shown in the following diagram, you can change the receive channels using the Utility mode's MIDI RCV CH (Receive Channel) parameter.

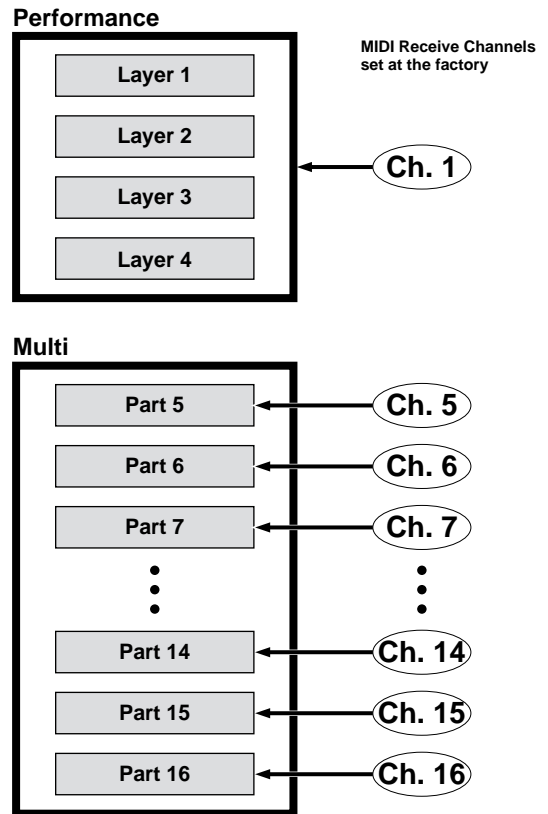

- If a channel is selected for both the Performance and one of the Multi Parts, the two will be played simultaneously, producing two sounds at once. Check the settings for the receive channels when you play the Performance and get an extra unintentional sound besides the Performance Layer.
- In Performance mode, you cannot modify the Multi settings on the panel except for the receive channel setting. Use an external MIDI device such as sequencer to modify the Multi settings.
- You can play only one Performance at a time. It is not possible to use the Performances as Parts for the Multi or to configure the Layers using the Performances.



In Multi Play mode you can play up to 16 Parts using an external MIDI sequencer. This mode is mainly used when the CS2x is used as an XG tone generator or as a music data input device in a computer music system. You can use any XG voice from the 586 normal voices and 20 drum voices. When recording to or playing back from an external sequencer you can use the Multi Part Edit function to set the volume and effects for each Part.

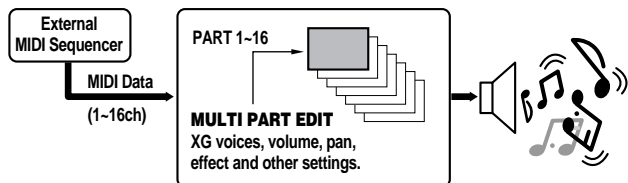

## Multi Part Edit Mode

In Multi Part Edit mode you can assign a voice to each Part and set volume, pan, effect and other parameters for each Part. These settings are temporary until you store them by performing a Multi Store operation (page 68). Therefore, entering Performance mode without storing the Multi will clear any settings you make.

## Entering Multi Play Mode

Press [MULTI] to enter Multi Play mode. A [▲] mark will appear below the word "MULTI" in the LCD to indicate Multi Play mode is engaged.

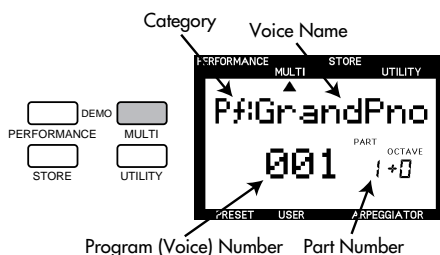

Playing the keyboard will play the voice of the currently selected Part as displayed in the LCD (1 ~ 16). The Category name for the selected voice will be shown next to the voice name.

You can select a voice from the 128 available normal voices in the XG000 (GM) Bank using the PROGRAM [-]/[+] buttons or the NUMERIC KEYPAD (0 ~ 9) and [ENTER]. Other normal voices plus drum voices are available in Multi Part Edit mode (see below).

**NOTE** When you enter Multi Play mode from Performance mode, the CS2x automatically resets the internal tone generator to XG ON (001 Grand Piano) status.

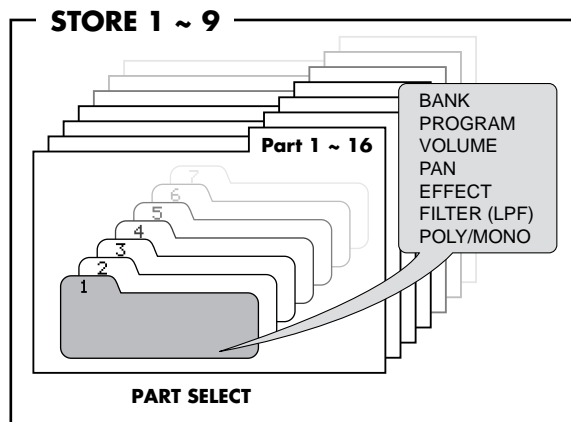

## Editing Procedure

### 1. Select a Part.

Press PART [-]/[+] to select the Part you want to edit.

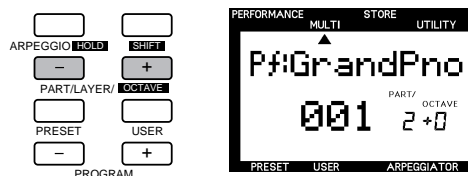

## 2. Select the parameter.

Press the Parameter Value [UP/DOWN] button corresponding to the parameter you want to edit once to select the parameter and engage Multi Part Edit mode. The name of the parameter and current settings will display in the LCD.

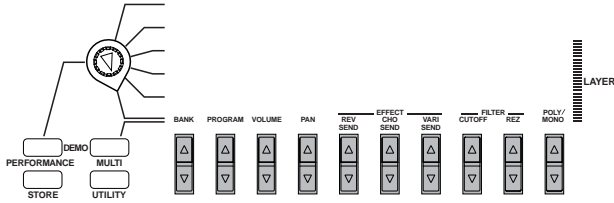

## 3. Set the value.

Press [UP/DOWN] again to set the value. Holding [UP/DOWN] scrolls through the settings. The [UP] button increases the value and the [DOWN] button decreases the value.

**NOTE** You can also use the NUMERIC KEYPAD (0 ~ 9) and [ENTER] or the ASSIGN 1/DATA knob to change the data value.

**NOTE** As you press other Parameter Value [UP/DOWN] buttons, the corresponding parameters will appear in the LCD. Set all other parameters to your preference.

## 4. Store the Multi.

When you have finished all editing operations, store the Multi. For details about how, see page 68.

**NOTE** To exit from Multi Part Edit mode, press the [MULTI] button again or the PROGRAM [-]/[+] button once, which will display the Voice Name screen. The display will return to the voice name screen. You can enter Performance mode directly from Multi mode by pressing the [PERFORMANCE] button.

## Description of Each Edit Function

### BANK

This lets you select a Bank of available voices which can be assigned to each Part (also see PROGRAM, below). Various normal voice banks containing up to 128 normal voices, plus a bank with different drum voices (kits), as well as SFX banks are available to choose from.

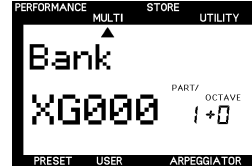

#### Settings:

**Bank:** off, XG000, 001, 003, 006, 008, 012, 014, 016~020, 024 ~ 028, 032~043, 045, 064 ~ 073, 096~101, SFX, SFXKT (SFX Kit), DRUM

**NOTE** In Multi Play mode all settings are available via the ASSIGN 1/DATA knob, but only certain ones are available when using the BANK [UP/DOWN] button.

Bank Conversion Table for The Multi

MSB	LSB	Bank	LCD
0	0	0	XG000
0	1	1	XG001
↓	↓	↓	↓
0	101	101	XG101
64	0	102	SFX
126	0	126	SFXKIT
127	0	127	DRUM
-	-	999	Off

A bank can be selected directly by inputting the corresponding BANK number with the NUMERIC KEYPAD (0 ~ 9) and [ENTER].

**NOTE** For more information about Banks and Programs (voices), see the XG Voice List in the separate "Data List" book.

## PROGRAM

This lets you select a voice, or program, from the currently selected BANK (see above).

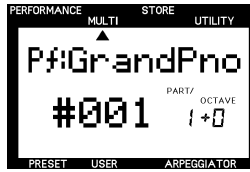

### Settings:

(Name): 1 ~ 128 (depending on selected Bank)

**NOTE** Note that the Program numbers available are 1 ~ 128 and the MIDI Program Change numbers range from 0 ~ 127. To match the MIDI Program Change number when switching programs using an external MIDI device, subtract a value of "1" from the CS2x Program number you want the MIDI message to select.

**NOTE** For more information about Banks and Programs (voices), see the XG Voice List in the separate "Data List" book.

**NOTE** You can also change the Program number with a single press of a number (0 ~ 9) of the NUMERIC KEYPAD by using the Quick Program Change function, just as in Performance mode (page 41).

### Normal Voices And Drum Voices

The available voices are divided into two groups: normal voices and drum voices. In Multi Play mode you can select and play both "normal" and "drum" voices for the selected Part.

A normal voice is a pitched voice which can be played on a musical scale from low to high, such as a piano or trumpet. In Multi Play mode there are 586 XG normal voices.

A drum voice is a complete set of drum and other percussion sounds, with each sound having a fixed pitch. Each sound is assigned to a specific MIDI Note number which also corresponds to a key on a MIDI keyboard. In Multi Play mode there are 20 XG drum voices. For a list of the drum and percussion sound assignments to each key, see the XG Drum Voice List in the separate "Data List" book.

### TG300B Mode

There are actually two tone generator modes: XG mode and TG300B mode. Normally the CS2x plays in XG mode. However, it automatically recognizes which mode to select based on incoming MIDI data, i.e. through MIDI System Exclusive messages that can be programmed into music data using an external MIDI sequencer.

In TG300B mode the CS2x will play multitimbral music data created for TG300B-compatible tone generators. TG300B mode also provides compatibility with the General MIDI System Level 1 format.

In TG300B mode the CS2x can:

- Play up to 16 Parts.
- Choose from 614 normal voices and 10 drum voices.

## VOLUME

This sets the volume of the selected Part. Different volume levels can be set for each Part.

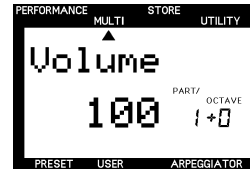

### Settings:

Volume: 0 ~ 127

## PAN

This sets the panning position (the left or right placement in the stereo spectrum) for each Part. Different pan positions can be set for each Part (for stereo output).



### Settings:

Pan: Random, L63 (far left position) ~ L01, C00 (center position), R01 ~ R63 (far right position)

**NOTE** When set to "Random", the panning of each Part will alternate between left and right when a voice is played.

**NOTE** Some of the voices are preset and fixed to a panning of "left" in the lower register and "right" in the higher register. In such a case you cannot modify the pan setting.

## EFFECT

This sets the effect send (output) level for each Part. There are three parameters: REV SEND (Reverb Send level), CHO SEND (Chorus Send level) and VARI SEND (Variation Send). You can change the effect send level for each effect in real-time when playing back XG song data containing effect settings using an external MIDI device.

**NOTE** When you press [MULTI] to enter Multi Play mode (reset to XG ON) each effect will be reset to the default settings: Hall 1 (Reverb), Chorus 1 (Chorus) and Delay L,C,R (Variation). In this case, the Reverb send level is set to 64, and the Chorus and Variation send levels are set to 0.

Depending on the XG song data being played, the effect types and their parameters used in the song may differ.

Note that the Performance Edit mode EFFECT TYPE parameters and their settings have no relation to the effect settings here.

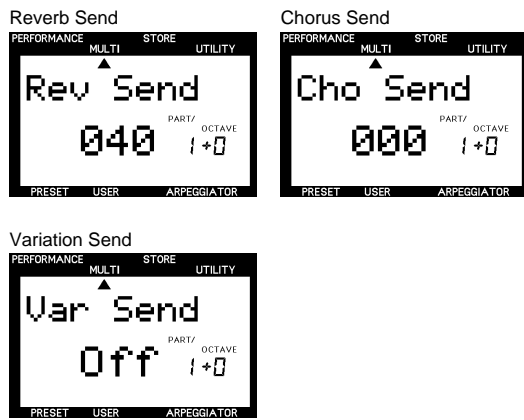

**REV SEND (Reverb Send):** Determines the send level of the Reverb effect.

**CHO SEND (Chorus Send):** Determines the send level of the Chorus effect.

**VARI SEND (Variation Send):** Enables or disables the output of the Variation effect.

**Settings:**

- Rev Send: 0 ~ 127
- Cho Send: 0 ~ 127
- Var Send: off, on (or 0 ~ 127\*)

**NOTE** \*The Variation send parameters are "off" or "on" when the Variation effect is used as the Insertion effect. They are 0 ~ 127 when used as the System effect. Normally, the Variation effect works as an Insertion Effect when not receiving parameter change messages to switch to System Effect from an external MIDI sequencer. For more information about Insertion and System effects, see page 70.

**FILTER**

This sets the filter parameters for each Part. There are two parameters: CUTOFF and REZ (resonance). These parameters affect the Low Pass Filter (LPF) only.

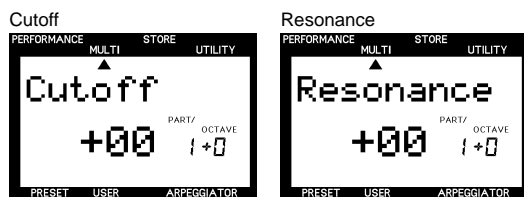

Generally filters change the timbre by passing signals within a specific frequency bandwidth and cutting others. Multi Play mode features a Low Pass Filter (LPF) which passes signals below the specified frequency point (the "cutoff frequency") and cuts off the signals above it.

**NOTE** Depending on the voice selected, changing certain parameters may not produce a noticeable effect.

**CUTOFF:** Determines the cutoff frequency of the filter, or the frequency point above which other frequencies are cut off or filtered out. Higher settings result in brighter sounds and lower settings result in darker sounds.

**REZ (Resonance):** Sets the amount of filter resonance or emphasis around the cutoff frequency. Higher settings produce a higher resonant peak, while lower settings produce a relatively flat response.

**Settings:**

- Cutoff: -64 ~ +63
- Resonance: -64 ~ +63

**POLY/MONO**

This determines whether the voice in each Layer is played monophonically (only one note at a time) or polyphonically (up to 64 notes at a time).

Generally, Polyphonic mode is selected to generate multiple sounds at one time. There are cases, however, where it is more effective to select Monophonic mode, such as when using a bass sound, brass sound, or an analog synthesizer sound.

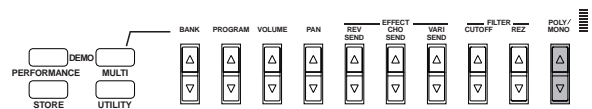

**Settings:**

**Mono/Poly:** mono, poly (also "----" for SFXKT and DRUM)

**NOTE** You can play up to 64 notes at a time. However, the number of notes may be reduced or truncated if you use multiple Parts in a rather complicated song which uses too many notes.

**Using Multi Play Mode**

- Multi Play mode is especially designed for using the CS2x as a multitimbral tone generator for an external MIDI sequencer, and all Part assignment and other settings can be controlled by MIDI messages as stored in the music data in the sequencer. To keep from losing any BANK, PROGRAM, VOLUME, PAN, EFFECT, FILTER, POLY/MONO assignments and settings you make in Multi Play Edit mode, however, you must perform a Multi Store operation (page 68) before switching to Performance mode.
- The Arpeggiator and Scene functions are not available in Multi Play Mode. They can only be used with the Performances in Performance mode.

In Utility mode you can set the CS2x system, MIDI and special assignment parameters.

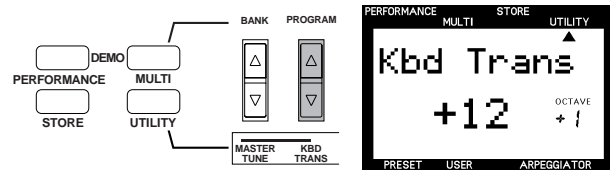
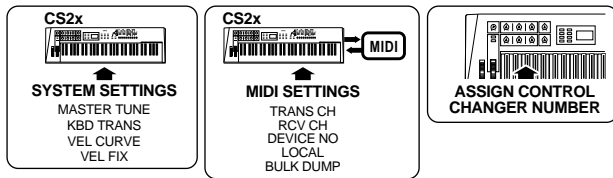

## Entering Utility Mode

Press [UTILITY] to enter Utility mode. A [▲] mark will appear below the word "UTILITY" in the LCD to indicate Utility mode is engaged.

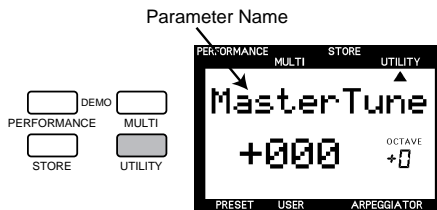

**NOTE** When you enter Utility mode the LCD will display the screen previously selected when you last exited Utility mode. The first time you press the [UTILITY] button after turning the power on, however, the LCD will display the SYSTEM MASTER TUNE screen.

## Procedure

### 1. Select the parameter.

Press the Parameter Value [UP/DOWN] button corresponding to the parameter you want to edit once to select the parameter. The name of the parameter and current setting will display in the LCD.

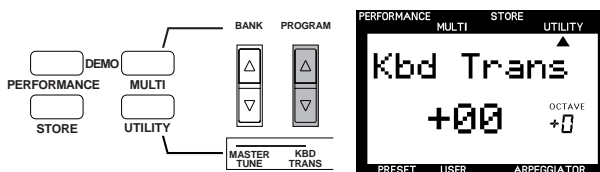

### 2. Set the value.

Press [UP/DOWN] again to set the value. Holding the Parameter Value [UP/DOWN] button changes the value continuously. Holding [UP/DOWN] scrolls through the settings. The [UP] button increases the value and the [DOWN] button decreases the value.

**NOTE** You can also use the NUMERIC KEYPAD (0 ~ 9) and [ENTER] or the ASSIGN 1/DATA knob to change the data value.

**NOTE** As you press other Parameter Value [UP/DOWN] buttons, the corresponding parameters will appear in the LCD. Set all other parameters to your preference.

**NOTE** To exit Utility mode press [PERFORMANCE] or [MULTI] to return to Performance or Multi Play mode, respectively.

**NOTE** It is not necessary to store changes made in the Utility mode as the CS2x will remember any changes you make.

## Description of Each Utility Function

### SYSTEM

This determines the tuning and other keyboard-related settings for the CS2x tone generator. There are four parameters: MASTER TUNE, KBD TRANS (Keyboard Transpose), VEL CURVE (Velocity Curve) and VEL FIX (Velocity Fix).

### MASTER TUNE

This tunes the CS2x's tone generator. The basic pitch is 440 Hz at note A3. Master tuning can be adjusted in 1 cent increments and decrements.



#### Settings

**MasterTune:** -102 to 0 (A3=440 Hz) to +102

**NOTE** A value of 100 cents is equal to one semitone.

## ■ KBD TRANS (Keyboard Transpose)

This lets you transpose the keyboard pitch in semitones. The transpose value will also be reflected in the OCTAVE display in the LCD.

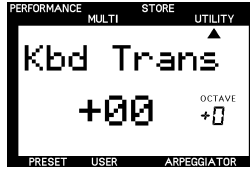

### Settings

**Kbd Trans:** -36 to 0 (standard pitch) to +36

**NOTE** Since the Keyboard Transpose setting is related to the OCTAVE SHIFT function, the setting will automatically change based on the OCTAVE SHIFT setting.

## ■ VEL CURVE (Velocity Curve)

The velocity curve set here determines the way the CS2x's tone generator responds to playing velocity when the VEL FIX parameter (see below) is set to "off". There are six types of curves available.

**norm (Normal):** The velocity is in proportion to the strength (how hard you play the keyboard).

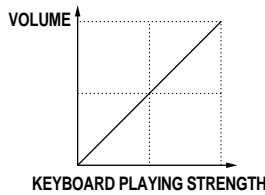

**soft1:** A softer playing style increases the volume level. This is suitable for people with a soft key touch.

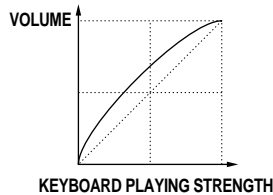

**soft2:** A softer playing style increases the volume level. Compared to Soft1, this is closer to Normal.

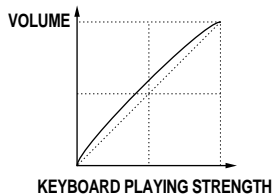

**easy:** This curve is also designed to increase the volume level with a softer playing style. However, the volume level is stable in all registers since the velocity curve in the mid range is close to Normal.

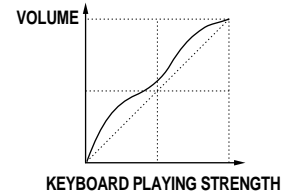

**wide:** A softer playing style lowers the volume level and a stronger playing style increases the volume level. As a result, you feel a wider dynamic range.

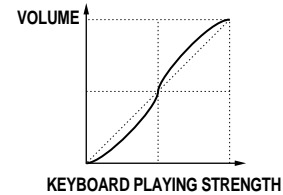

**hard:** A stronger playing style increases the volume level. This is suitable for people with a strong key touch.

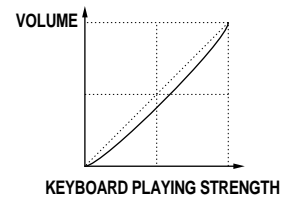

### Settings

**Vel Curve:** norm, soft1, soft2, easy, wide, hard

## ■ VEL FIX (Velocity Fix)

This "fixes" the velocity of the CS2x keyboard to a specific value. This is used when you want to play the sound at a fixed velocity regardless of keyboard touch.



### Settings

**Vel Fix:** off, 1 ~ 127

**NOTE** Set VEL FIX to "off" to enable the velocity curve selected in VEL CURVE (see above).

## MIDI

The MIDI parameters determine key aspects of how the CS2x exchanges data with an external MIDI device. There are five parameters: TRANS CH (Transmit Channel), RCV CH (Receive Channel), DEVICE NO (Device Number), LOCAL and BULK DUMP.

### ■ TRANS CH (Transmit Channel)

This sets the MIDI transmit channel over which the CS2x will send MIDI data to an external MIDI device such as a sequencer.



#### Settings

**Trans Ch:** 1 ~ 16

**NOTE** You can use the CS2x to send data to an external MIDI device such as a music sequencer. For details, see page 12.

### ■ RCV CH (Receive Channel)

In Performance mode, this sets the MIDI receive channel for controlling the CS2x by an external device such as a MIDI sequencer or computer music software application.

In Multi Play mode, the CS2x resets the internal tone generator to XG ON (001 Grand Piano) status and automatically receives the external data.



#### Settings

**Perf Rch:** LAYER A (“All” Performance Layer voices) = Channel 1 ~ 16, PART 5~16 = Channel 1 ~ 16, off

**NOTE** In Performance mode, the receive channels can be set for receiving MIDI note and other data to play the Performance Layer plus 12 Parts (Part 5 ~ 16) as set up for the Multi (see Multi Play mode). However, you cannot use the Insertion effect for Parts 5 ~ 16 (see Digital Effects, page 70).

**NOTE** To select the Layer (“A” or Part (“5 ~ 16”) which you want to assign a MIDI channel to, use the PART/LAYER [-]/[+] buttons.

### ■ DEVICE NO (Device Number)

This sets the MIDI device number. When transmitting or receiving system exclusive messages such as bulk dump or parameter change messages with an external MIDI device, you must set the CS2x and the external device to the same device number.



#### Settings

**Device No.:** 1 ~ 16, all, off

### ■ LOCAL

This determines whether the CS2x’s keyboard is connected to the internal tone generator. For normal play, LOCAL should be set to “on”. When using the CS2x as a master keyboard controller for sending note and other data to a MIDI music sequencer, LOCAL should be set to “off”. When LOCAL is set to “off”, the keyboard is disconnected from the tone generator, the CS2x’s internal tone generator will not respond to the keyboard (no sound will be produced) when you play, but the keyboard still transmits MIDI messages from the MIDI OUT terminal. At the same time, the CS2x’s internal tone generator will respond to incoming MIDI data received at the MIDI IN terminal from an external device.

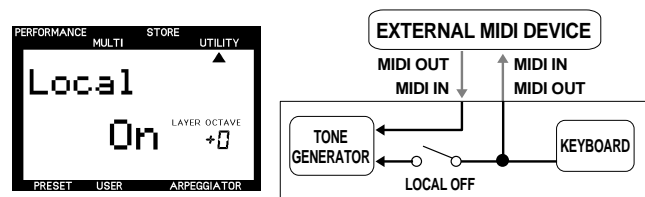

#### Settings

**Local:** on, off

## ■ BULK DUMP

This function is used for sending CS2x Performance data in bulk to another CS2x or to a MIDI data storage devices such as the Yamaha MIDI Data Filer MDF3. This is convenient for backing up, saving or managing your important Performance data.

### Settings

**Bulk Dump:** 1Perf, All

**NOTE** To enable transmission, first connect the MIDI devices using MIDI cables. (For details about setting up each device, see the respective owner's manuals for the external MIDI devices.) Also, you must match the device number of the CS2x with the device number of the external MIDI device (see DEVICE NO, above).

### Bulk Dump Send

1. Select the type of data you want to “dump” to the external device using the BULK DUMP [UP/DOWN] button.



**1Perf:** Sends the Preset or User Performance data currently selected in Performance mode.

**All:** Sends all of the User Performance data as well as the System data settings.

**NOTE** The CS2x does not transmit Multi data in bulk.

2. Press [ENTER] to execute the bulk dump operation. The word “End” will appear in the LCD when the operation is completed, and the LCD will return to the original display.

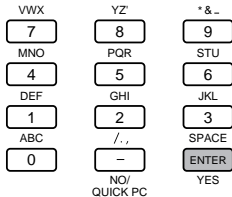

### Bulk Dump Receive

The CS2x can receive Performance data from an external device, to load it back into the CS2x in bulk. The CS2x stands ready to receive the data when a Bulk Dump operation is executed by the external MIDI device. The data that can be received will differ depending on the mode. (For details about MIDI data format information, see the separate “Data List” book.) You must match the device number of the CS2x with the device number of the external MIDI device (see DEVICE NO, above).

**NOTE** The CS2x can also receive CS1x bulk data. Depending on wave and other data, the sound might be somewhat different.

## ■ ASSIGN CTRL NO (Assign Control Number)

This lets you assign Control Change Numbers to controllers such as the MODULATION wheel and SOUND CONTROL knobs. This is mainly used to control external MIDI devices connected to the CS2x via MIDI cables.

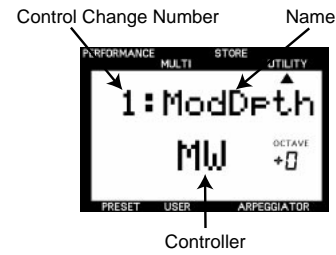

**NOTE** The main function of the SOUND CONTROL knobs will not be changed.

**NOTE** You can designate whether the MODULATION wheel or the Foot Controller is used for Scene Control (page 26).

**NOTE** The table below lists which controller the LCD abbreviations correspond to.

Controller	LCD
Modulation Wheel	MW
Sound Control Knob 1 (ATTACK)	Knob1
Sound Control Knob 2 (DECAY)	Knob2
Sound Control Knob 3 (RELEASE)	Knob3
Sound Control Knob 4 (ASSIGN 1/DATA)	Knob4
Sound Control Knob 5 (HPF CUTOFF)	Knob5
Sound Control Knob 6 (LPF CUTOFF)	Knob6
Sound Control Knob 7 (RESONANCE)	Knob7
Sound Control Knob 8 (ASSIGN 2)	Knob8
Footswitch connected to the FOOTSWITCH jack on the rear panel	FS
Foot Controller connected to the FOOT CONTROLLER jack on the rear panel	FC
Foot Volume pedal connected to the FOOT VOLUME jack on the rear panel	FV

**NOTE** In the Scene Control settings, you can choose from Mod. Wheel (MODULATION wheel) or FootCtrl (FOOT CONTROLLER) to determine the controller for Scene morphing.

SCENE 1 or 2 buttons (only for the Scene Control)	Scene
---	-------



The table below lists the Control Change Numbers and Names that can be assigned to the various controllers.

Assignable Control Change Numbers and Names

Control Change Number	Name	LCD
1	Modulation Depth	ModDpth
5	Portament Time	PortaTm
6	Data Entry MSB	DataMSB
7	Main Volume	MainVol
10	Panpot	Panpot
11	Expression	Expres.
16	General purpose1	Gener1
17	General purpose2	Gener2
18	General purpose3	Gener3
19	General purpose4	Gener4
38	Data Entry LSB	DataLSB
64	Hold 1(Damper/Sustain)	Hold1
65	Portament Switch	PortaSW
66	Sostenute	Sostenut
67	Soft Pedal	Soft
71	Harmonic Contents	Harmonic
72	Release Time	RelTime
73	Attack Time	AtkTime
74	Brightness	Bright.
80	General Purpose 5	Gener5
81	General Purpose 6	Gener6
82	General Purpose 7	Gener7
83	General Purpose 8	Gener8
84	Portament Control	PortaCt
91	Reverb Depth	Reverb
93	Chorus Depth	Chorus
94	Variation Depth	Vari
Others	-----	-----

**NOTE** *General Purpose:* With the CS2x, General Purpose 1 is for FC, 2 is for Knob 4 (ASSIGN 1/DATA), 3 is for Knob 8 (ASSIGN 2), 4 is for no setting, 5 is for Knob 2 (DECAY), 6 is for Knob 5 (HPF CUTOFF) and 7 and 8 are for no setting.

### Assigning The Controllers

1. Move the panel controller (i.e. a SOUND CONTROL knob or the MODULATION wheel) to which the Control Change Number is to be assigned. The parameters for the controller will appear in the LCD.

**NOTE** Press a [SCENE] button to display the Scene Control parameters.

2. Press ASSIGN CTRL NO [UP/DOWN] button to select the Control Change Number and Name.

3. Repeat steps 1 and 2 to assign the Control Change Numbers and Names to each controller.

**NOTE** This function is especially convenient for controlling an external MIDI device with the CS2x (see page 72).

### About The SOUND CONTROL Knobs

Changes made by the SOUND CONTROL knobs can be output as MIDI messages via the MIDI OUT terminal as assigned using the ASSIGN CTRL NO function.

The default assignments for the SOUND CONTROL knobs as set at the factory are as follows:

- Knob 1           73: Attack Time
- Knob 2           80: General Purpose 5
- Knob 3           72: Release Time
- Knob 4           17: General Purpose 2
- Knob 5           81: General Purpose 6
- Knob 6           74: Brightness
- Knob 7           71: Harmonic Content
- Knob 8           18: General Purpose 3

- When the CS2x receives the data assigned to each SOUND CONTROL knob from an external MIDI device, the parameter printed on the panel for the knob will be affected. For example, when the message for Brightness (74) is received from an external device, the Attack Time will be affected when the Brightness (74) is assigned to Knob 1 and the Attack Time (73) is assigned to Knob 3.
- Both the data assigned to the Knob using the ASSIGN CTRL NO function and parameter data as printed on the panel for the Knob are sent to the internal tone generator when turning the Knob. For example, when you turn Knob 1, both Brightness (74) and Attack Time will be affected when Brightness (74) is assigned to Knob 1.



In Store mode you can store edited Performances, Scenes or the Multi in the CS2x's internal memory.

**NOTE** To enter Store mode, you must first be in Performance or Multi Play mode. You cannot enter Store mode from Utility mode.

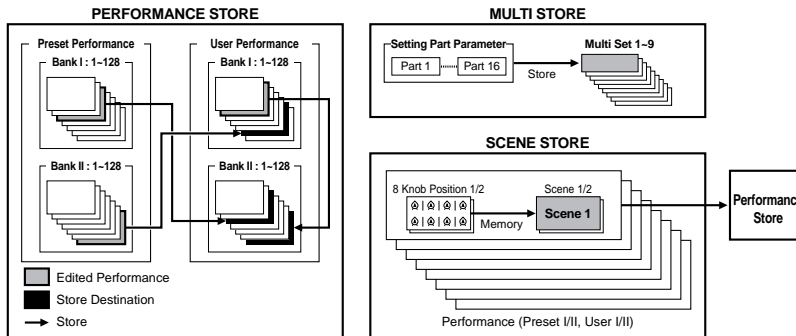

## Storing A Performance

- After editing a performance, press the [STORE] button to enter Store mode. A [▲] mark will appear below the word "STORE" in the LCD to indicate Store mode is engaged.

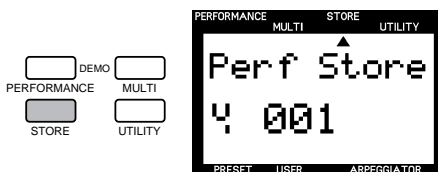

- Press [USER] to select the User Performance bank in which you want to store the Performance.

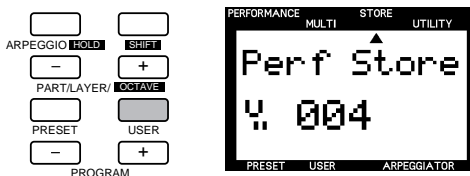

- Select the User Performance number in which you want to store the Performance using the NUMERIC KEYPAD (0 ~ 9) and [ENTER], the PROGRAM [-]/[+] buttons, or the ASSIGN 1/DATA knob.



**CAUTION** If you write over an existing User Performance, the data previously stored there will be lost. To be safe, always store your important data to an external device such as the Yamaha MIDI Data Filer MDF3.

**NOTE** To rename the Performance, use the PERFORM NAME parameter in Performance Edit mode (page 45).

- Press [ENTER]. The word "Sure?" will appear in the LCD.

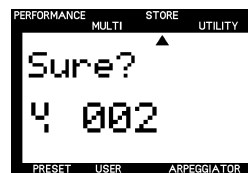

To confirm the sound, simply play the keyboard.

- Press [YES] to execute the store operation. After the data is stored the LCD will return to the Performance Play mode screen.

If you don't want to store the Performance, press [NO] to cancel the store operation.

**NOTE** Pressing the [PERFORMANCE] button will exit Store mode.



When storing a Performance, the position of each SOUND CONTROL knob will also be stored. Therefore, when selecting the stored User Performance in Performance Play mode, the CS2x will produce the sound affected by each SOUND CONTROL knob position at that time. (Turning the knob will restore the sound with the current SOUND CONTROL knob positions.)

## Storing A Scene

There are two Scene memories in each Performance. The Scene Store function is used to assign a Scene, or the position of the eight SOUND CONTROL knobs, to either [SCENE 1] or [SCENE 2] of the currently selected Performance. This is convenient for live performances or recording sessions, since it lets you access a particular setting simply by pressing a [SCENE] button.

**NOTE** Two Scenes can be stored in each Performance.

**CAUTION** Storing a Scene to the edit buffer will only remain in effect as long as the current Performance is selected. To store the Scene data permanently in the selected Performance you must execute the Performance Store operation (see above). Otherwise, you will lose the Scene settings if you select another Performance or enter Multi Play mode. Also, before executing the Performance Store operation, be sure to turn all the SOUND CONTROL knobs to their center positions.

1. Set each SOUND CONTROL knob to the position of your preference.

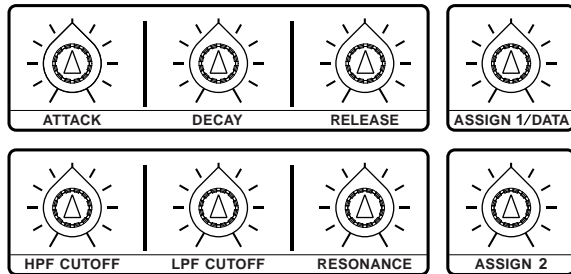

2. To store the current SOUND CONTROL knob settings to the Scene 1 temporary buffer memory, hold [STORE] and press [SCENE 1]. To store another set of SOUND CONTROL knob settings to the Scene 2 temporary buffer memory, hold [STORE] and press [SCENE 2].

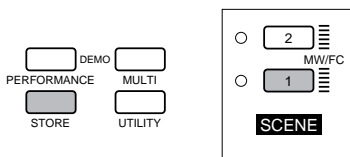

The “OK” message will appear in the LCD when the Scene is stored to the temporary buffer memory.



3. To permanently store the Scenes to the currently selected Performance, execute the Performance Store operation.

### Selecting Scenes

First select the Performance to which you have stored Scenes. Then press [SCENE 1] or [SCENE 2] to select the desired Scene. The LED by the selected button will light to indicate that you have activated the Scene settings.

Each SOUND CONTROL knob will be disabled when a Scene is selected, and you will not be able to change the parameters using the knobs.

When the SCENE CONTROL function is activated by pressing both [SCENE] buttons simultaneously (both LEDs will be lit), you can use the MODULATION wheel or a connected Foot Controller to “morph” between the sound of each Scene in real-time. The minimum position of the controller is Scene 1, and the maximum position is Scene 2. For details about determining which controller is assigned to the SCENE CONTROL function, see page 64.

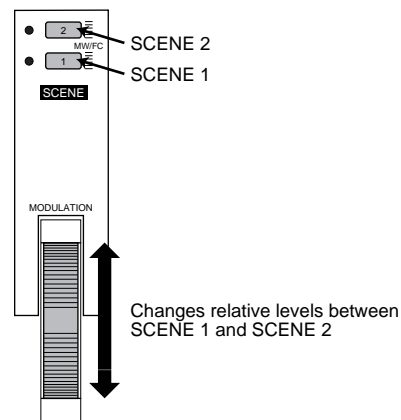

## Storing The Multi

1. After editing the Part settings, press the [STORE] button to enter Store mode. The word “MultiStore” will appear in the LCD.



2. Use the NUMERIC KEYPAD (1 ~ 9) to select one of the nine available User Multi memory locations.
3. Press [ENTER]. The word “Sure?” will appear in the LCD.

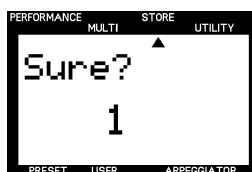

4. Press [YES] to execute the store operation. After the data is stored the LCD will return to the Multi Play mode screen.

If you don't want to store the Multi, press [NO] to cancel the store operation.

**NOTE** Pressing the [MULTI] button will exit Store mode.

**NOTE** When storing the Multi, only the Multi Edit menu parameter settings for each Part will be stored, and the position of each SOUND CONTROL knob will not.

## Recalling A Stored Multi

In Multi Play mode, hold [MULTI] and use the NUMERIC KEYPAD (1 ~ 9) to select one of the nine User Multis.

**NOTE** You can press 0 in the NUMERIC KEYPAD to select XG mode = ON.



## Factory Settings

You can reset all of the settings in the CS2x (Performance, Scene, System and MIDI settings) to the original factory (initial) default settings.

**NOTE** Executing this function will replace all of your existing data. As such, always store your important data to an external device such as the Yamaha MIDI Data Filer MDF3 beforehand.

Turn the power of the CS2x off. Then, while holding the 7, 8, and 9 keys on the NUMERIC KEYPAD, turn the power back on.

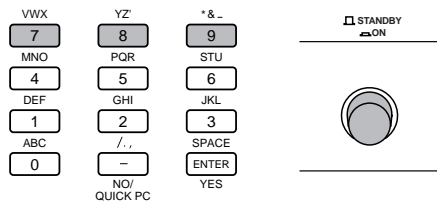

# APPENDIX

## Digital Effects

The CS2x features three independent digital effects units, Reverb, Chorus and Variation, which can be applied to the voices in a variety of ways to provide a wide range of sound processing capabilities. In Performance mode you can choose the Reverb, Chorus and Variation effect types, as well as set additional parameters for the Variation effect. In Multi Play mode, system exclusive (MIDI) data programmed in a song sequence (of an external sequencer or computer) can change the various CS2x effect parameters at specific points in the song to greatly enhance the sound and impact of the playback.

### ■ Type 1: Reverb

Reverb recreates the sounds of various environments by adding room ambiance through delays or reflections. There are 12 Reverb types to choose from. (See the Effect Type List in the separate "Data List" book.)

### ■ Type 2: Chorus

Chorus creates a variety of rich, spacious-sounding effects which are especially dramatic in stereo. There are 14 Chorus effect types, including Chorus and Flanger. (See the Effect Type List in the separate "Data List" book.)

### ■ Type 3: Variation

Variation is a special section of various effects including Reverb and Chorus, plus many others not found in the other sections, such as Distortion, Wah, and Auto Pan. There are 62 Variation effect types. (See the Effect Type List in the separate "Data List" book.)

### System and Insertion Effects

The CS2x effects sections can be designated as either System or Insertion effects. Reverb and Chorus are always System effects, which means they can be applied to any or all Parts. The Variation effect can also be a System effect, or it can be designated as an Insertion effect, which means it can be dedicated to a specific Part.

Basically, CS2x System and Insertion effects work the same way as in a sound mixer, as shown in the diagram at right. For example, System effects can be applied to musical instruments (i.e. Parts) which are connected to the various mixer channels; the amount of each System effect is determined by channel "send" and system "return" level controls. An Insertion effect can be connected ("inserted") into the signal flow of a specific channel in order to process the sound of that instrument (i.e. Layer/Part) only.

With the CS2x, in Performance mode the Insertion effect (Variation) can be applied to one or more of the four Layers, while in Multi Play mode it can only be applied to a single Part.

The System and Insertion effect configurations can be controlled in detail by XG song data (signified by the XG mark) when the CS2x is in Multi Play mode.

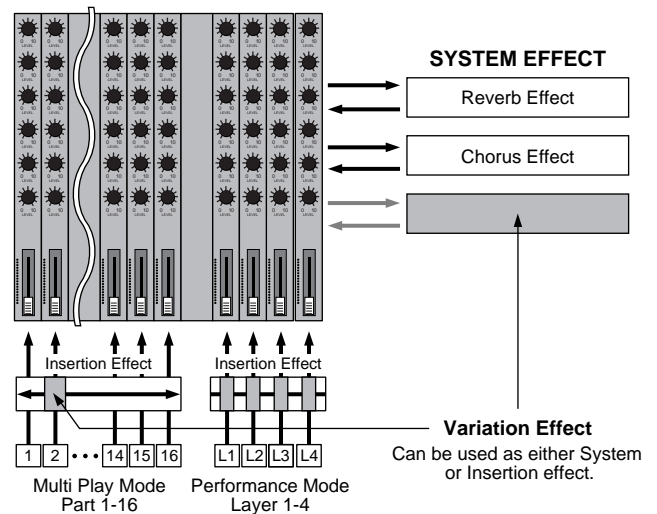

### Performance Mode

The diagram below shows the signal flow of the three effects when the CS2x is in Performance mode. In this case the Variation effect is fixed as the Insertion effect.

The Variation Send On/Off switch **1** determines which Layers the Variation effect is applied to. The Performance Layer Edit 4 menu EFFECT VARI SEND parameter turns the Variation effect ON/OFF for each Layer (page 55).

The Variation effect wet/dry balance **2** determines the ratio of effected (wet) signal to original (dry) signal. The resulting Variation effect signal is then sent to the Reverb effect via the Reverb send control **3**, and to the Chorus effect via the Chorus send control **4**; the Send Chorus To Reverb signal **5** can be controlled by the ASSIGN 1 knob. The Performance Layer Edit 4 menu EFFECT REV SEND **6** and CHO SEND **7** parameters determine the respective Reverb and Chorus send levels applied to each Layer (page 55). Layers which are switched off **1**, as well as Parts 5~16, can still have System Reverb and Chorus effects applied to them.

## PERFORMANCE

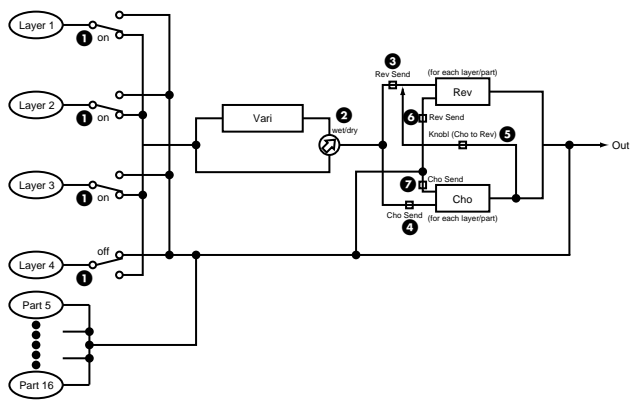

**NOTE** Reverb and Chorus send levels for Layers with the Variation Send On/Off switch set to ON are determined by the highest numbered Layer. For example, if Layers 1, 2 and 3 are switched on, then the Reverb and Chorus send level for Layer 3 will determine the amount of effect applied to each Layer.

**NOTE** In Performance mode effect send levels for Parts 5~16 (as well as Layers 1~4) can be controlled by an external MIDI sequencer. The Variation effect cannot be applied to Parts 5~16.

## Multi Play Mode

The diagram below shows the signal flow of the three effects when the CS2x is in Multi Play mode and the Variation effect is designated as an Insertion effect.

**NOTE** In Multi Play mode the various effect settings can be controlled by MIDI system exclusive Parameter Change messages (received from an external sequencer or computer). The illustrations at right show the Reverb, Chorus and Variation send parameters which can be controlled from the CS2x panel. For details about the others, refer to each page number as listed in the following explanation.

**NOTE** When the CS2x is in Multi Play mode, the Variation Effect is automatically reset as an Insertion Effect. If you want to set the Variation Effect as a System Effect, you need to send a parameter change message to the CS2x from an external MIDI sequencer.

The Variation (Insertion) effect can be applied to any one of the 16 Parts at a time, designated by switching the Multi Edit EFFECT VARI SEND parameter to ON (page 60). The ratio of Variation effect (wet) signal to original (dry) signal is determined by the wet/dry balance (1), which in turn controls the amount of Variation effect signal applied to the Part (page 60).

Although only one Part at a time can have the Variation effect applied to it, all Parts, including the Part with Variation effect, can have Reverb and Chorus applied, determined by the Reverb send (2) and Chorus send (3) level settings (between 0~127) of the Multi Edit EFFECT REV SEND and CHO SEND parameters, respectively (page 60). Reverb return (4) and Chorus return (5) levels can also be controlled to determine the amount of each effect applied. The Send Chorus to Reverb (6) level from the Chorus effect to the Reverb effect can also be controlled in a series, if you assign it to the ASSIGN 1 knob (page 47); in this case, the Chorus return % level should be set to "0".

## MULTI

- XG effect set to Insertion
- Part 3 VARI SEND set to ON

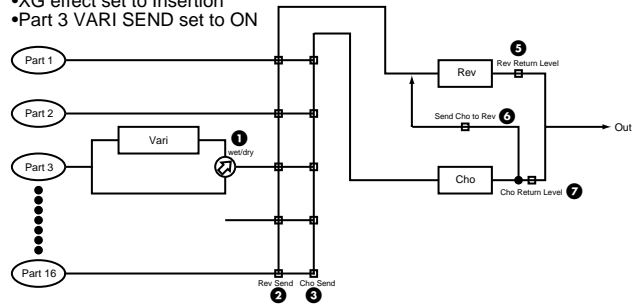

The diagram below shows the signal flow of the three effects when the CS2x is in Multi Play mode and the Variation effect is designated as a System effect.

Each of the 16 Parts has a Dry send (1) level which controls the amount of original signal for each Part (page 60). Reverb send (2), Chorus send (3), and Variation send (4) levels control the amount of effect applied to each Part, determined by the Multi Edit EFFECT REV SEND, CHO SEND and VARI SEND parameters (between 0~127), respectively (page 60). Reverb return (5), Chorus return (6) and Variation return (7) levels can also be controlled to determine the amount of each effect applied (page 60).

The Send Chorus to Reverb (8) level is sent from the Chorus effect to the Reverb effect (page 60). The Send Variation to Reverb (9) and Send Variation to Chorus (10) levels are sent from the Variation effect to the Reverb and Chorus effects, respectively (page 60). These three parameters let you make series and parallel effect configurations which provide enormous sound enhancement flexibility.

- XG effect set to System

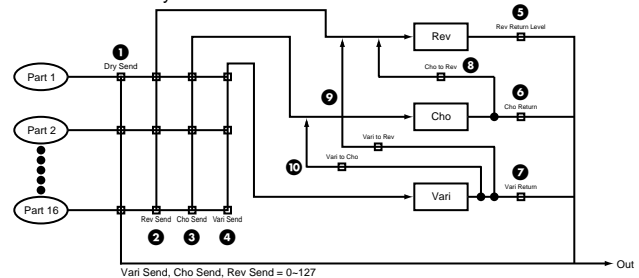

**NOTE** If you select Effect Off in the Variation Type menu, the Layers which have the VARI SEND function set to ON will not sound. When you don't want to use the Variation Effect on the Layers, set the VARI TYPE to Thru.

# About MIDI

MIDI is an acronym that stands for Musical Instrument Digital Interface, which allows electronic musical instruments to communicate with each other, by sending and receiving compatible Note, Control Change, Program Change and various other types of MIDI data, or messages.

The CS2x can control a MIDI device by transmitting note related data and various types of controller data. The CS2x can be controlled by the incoming MIDI messages which automatically determine tone generator mode, select MIDI channels, voices and effects, change parameter values, and of course play the voices specified for the various Parts.

Many MIDI messages are expressed in hexadecimal or binary numbers. Hexadecimal numbers may include the letter "H" as a suffix. The letter "n" indicates a certain whole number.

The chart below lists the corresponding decimal number for each hexadecimal/binary number.

Decimal	Hexadecimal	Binary
0	00	0000 0000
1	01	0000 0001
2	02	0000 0010
3	03	0000 0011
4	04	0000 0100
5	05	0000 0101
6	06	0000 0110
7	07	0000 0111
8	08	0000 1000
9	09	0000 1001
10	0A	0000 1010
11	0B	0000 1011
12	0C	0000 1100
13	0D	0000 1101
14	0E	0000 1110
15	0F	0000 1111
16	10	0001 0000
17	11	0001 0001
18	12	0001 0010
19	13	0001 0011
20	14	0001 0100
21	15	0001 0101
22	16	0001 0110
23	17	0001 0111
24	18	0001 1000
25	19	0001 1001
26	1A	0001 1010
27	1B	0001 1011
28	1C	0001 1100
29	1D	0001 1101
30	1E	0001 1110
31	1F	0001 1111
32	20	0010 0000
33	21	0010 0001
34	22	0010 0010
35	23	0010 0011
36	24	0010 0100
37	25	0010 0101
38	26	0010 0110
39	27	0010 0111
40	28	0010 1000
41	29	0010 1001
42	2A	0010 1010
43	2B	0010 1011
44	2C	0010 1100
45	2D	0010 1101
46	2E	0010 1110
47	2F	0010 1111
48	30	0011 0000
49	31	0011 0001
50	32	0011 0010
51	33	0011 0011
52	34	0011 0100
53	35	0011 0101
54	36	0011 0110
55	37	0011 0111
56	38	0011 1000
57	39	0011 1001
58	3A	0011 1010
59	3B	0011 1011
60	3C	0011 1100
61	3D	0011 1101
62	3E	0011 1110
63	3F	0011 1111

Decimal	Hexadecimal	Binary
64	40	0100 0000
65	41	0100 0001
66	42	0100 0010
67	43	0100 0011
68	44	0100 0100
69	45	0100 0101
70	46	0100 0110
71	47	0100 0111
72	48	0100 1000
73	49	0100 1001
74	4A	0100 1010
75	4B	0100 1011
76	4C	0100 1100
77	4D	0100 1101
78	4E	0100 1110
79	4F	0100 1111
80	50	0101 0000
81	51	0101 0001
82	52	0101 0010
83	53	0101 0011
84	54	0101 0100
85	55	0101 0101
86	56	0101 0110
87	57	0101 0111
88	58	0101 1000
89	59	0101 1001
90	5A	0101 1010
91	5B	0101 1011
92	5C	0101 1100
93	5D	0101 1101
94	5E	0101 1110
95	5F	0101 1111
96	60	0110 0000
97	61	0110 0001
98	62	0110 0010
99	63	0110 0011
100	64	0110 0100
101	65	0110 0101
102	66	0110 0110
103	67	0110 0111
104	68	0110 1000
105	69	0110 1001
106	6A	0110 1010
107	6B	0110 1011
108	6C	0110 1100
109	6D	0110 1101
110	6E	0110 1110
111	6F	0110 1111
112	70	0111 0000
113	71	0111 0001
114	72	0111 0010
115	73	0111 0011
116	74	0111 0100
117	75	0111 0101
118	76	0111 0110
119	77	0111 0111
120	78	0111 1000
121	79	0111 1001
122	7A	0111 1010
123	7B	0111 1011
124	7C	0111 1100
125	7D	0111 1101
126	7E	0111 1110
127	7F	0111 1111

## MIDI Messages Transmitted/Received by the CS2x

MIDI messages can be divided into two groups: Channel messages and System messages. Below is an explanation of the various types of MIDI messages which the CS2x can receive/transmit.

### 1. CHANNEL MESSAGES

Channel messages are the data related to the performance on the keyboard for the specific channel.

#### 1.1 Note On/Note Off (Key On/Key Off)

Messages which are generated when the keyboard is played.

Reception note range = C-2 (0) - G8 (127), C3 = 60

Velocity range = 1 - 127 (Only the Note On velocity is received)

Note On: Generated when a key is pressed.

Note Off: Generated when a key is released.

Each message includes a specific note number which corresponds to the key which is pressed, plus a velocity value based on how hard the key is struck.

#### 1.2 Control Change

Control Change messages let you select a voice bank, control volume, panning, modulation, portamento time, brightness and various other controller parameters, through specific Control Change numbers which correspond to each of the various parameters.

##### 1.2.1 Bank Select MSB (Control #000) Bank Select LSB (Control #032)

Messages which select variation voice bank numbers by combining and sending the MSB and LSB from an external device.

MSB and LSB functions differently depending on the tone generator mode.

In XG mode, MSB numbers select voice type (Normal Voice or Drum Voice), and LSB numbers select voice banks.

In TG300B mode, LSB is fixed, and MSB numbers select voice banks.

(For more information about Banks and Programs, see Voice List in the "Data List" book.)

A new bank selection will not become effective until the next Program Change message is received.



### 1.2.2 Modulation (Control #001)

Messages which control vibrato depth using the Modulation Wheel. Setting the value to 127 produces maximum vibrato and 0 results in vibrato off.

### 1.2.3 Portamento Time (Control #005)

Messages which control the duration of portamento, or a continuous pitch glide between successively played notes. When the parameter 1.2.10 Portamento Switch is set to on, the value set here can adjust the speed of pitch change. Setting the value to 127 produces maximum portamento time and 0 results in minimum portamento time.

### 1.2.4 Data Entry MSB (Control #006) Data Entry LSB (Control #038)

Messages which set the value for the parameter specified by 1.2.23RPN MSB/LSB and 1.2.22 NRPN MSB/LSB. Parameter value is determined by combining MSB and LSB.

### 1.2.5 Main Volume (Control #007)

Messages which control the volume of each Part. Setting the value to 127 produces maximum volume and 0 results in volume off. The messages 007 (Main Volume) or 011 (Expression) will be transmitted using an optional controller connected to the FOOT VOLUME jack on the rear panel if an appropriate setting is selected in the Assign Control Number section in Utility mode.

### 1.2.6 Pan (Control #010)

Messages which control the stereo panning position of each Part (for stereo output). Setting the value to 127 positions the sound to the far right and 0 positions the sound to the far left.

### 1.2.7 Expression (Control #011)

Messages which control intonation expression of each Part during performance. Setting the value to 127 produces maximum volume and 0 results in volume off. The messages 007 (Main Volume) or 011 (Expression) will be transmitted using an optional controller connected to the FOOT VOLUME jack on the rear panel if an appropriate setting is selected in the Assign Control Number section in Utility mode.

### 1.2.8 General Purpose 1, 2, 3, 4, 5, 6, 7, 8 (Control #016, #017, #018, #019, #080, #081, #082, #083)

Control #016 are messages which are transmitted by operating the connected Foot Controller, used to control specific parameter such as voice parameters and Variation effect parameters. Control #017 and Control #018 are messages which are transmitted by operating the ASSIGN1 and ASSIGN2 knobs, respectively. Control #080 and #081 are transmitted by operating the DECAy and HPF Cutoff Knobs, respectively. Control #019, #082 and #083 are undefined.

### 1.2.9 Hold1 (Control #064)

Messages which control sustain on/off. Setting the value between 64 - 127 turns the sustain on, between 0 - 63 turns the sustain off.

### 1.2.10 Portamento Switch (Control #065)

Messages which control portamento on/off. Setting the value between 64 -127 turns the portamento on, between 0 - 63 turns the portamento off.

### 1.2.11 Sostenuto (Control #066)

Messages which control sostenuto on/off. Holding specific notes and then pressing and holding the sostenuto pedal will sustain those notes as you play subsequent notes, until the pedal is released. Setting the value between 64 -127 turns the sostenuto on, between 0 - 63 turns the sostenuto off.

### 1.2.12 Soft Pedal (Control #067)

Messages which control soft pedal on/off. Notes played while holding the soft pedal will be dampened. Setting the value between 64 -127 turns the soft pedal on, between 0 - 63 turns the soft pedal off.

### 1.2.13 Harmonic Content (Control #071)

Messages which adjust the filter resonance set for each voice. The value set here is an offset value which will be added to or subtracted from the voice data. Higher values will result in a more characteristic, resonant sound. Depending on the voice, the effective range may be narrower than the range available for adjustment.

### 1.2.14 Release Time (Control #072)

Messages which adjust the EG release time set for each voice. The value set here is an offset value which will be added to or subtracted from the voice data.

### 1.2.15 Attack Time (Control #073)

Messages which adjust the EG attack time set for each voice. The value set here is an offset value which will be added to or subtracted from the voice data.

### 1.2.16 Brightness (Control #074)

Messages which adjust the filter cutoff frequency set for each voice. The value set here is an offset value which will be added to or subtracted from the voice data. Lower values will result in a softer sound. Depending on the voice, the effective range may be narrower than the range available for adjustment.

### 1.2.17 Portamento Control (Control #084)

Messages which apply a portamento between the currently-sounding note and the subsequent note.

Portamento Control is transmitted specifying the note-on key of the currently-sounding note.

Specify a Portamento Source Key number between 0 - 127.

When a Portamento Control message is received, the currently sounding pitch will change with a Portamento Time of 0 to the next note-on key on the same channel.

For example, the following settings would apply a portamento from note C3 to C4.

```
90H 3CH 7FH    C3 Note on
BOH 54H 3CH    Source key number set to C3
90H 48H 7FH    C4 Note on (When C4 is on, C3 is raised by a
                portamento to C4.)
```

### 1.2.18 Effect1 Depth (Reverb Send Level) (Control #091)

Messages which adjust the send level for the Reverb effect.

### 1.2.19 Effect3 Depth (Chorus Send Level) (Control #093)

Messages which adjust the send level for the Chorus effect.

### 1.2.20 Effect4 Depth (Variation Effect Send Level) (Control #094)

Messages which adjust the send level for the Variation effect.

If Variation effect uses System effect, this message sets the send level for the Variation effect. If it uses Insertion effect, this setting is invalid.

### 1.2.21 Data Increment (Control #096) Decrement (Control #097) for RPN

Messages which increase or decrease the MSB value of pitch bend sensitivity, fine tune, or coarse tune in steps of 1. You are required to assign one of those parameters using the RPN in the external device in advance.

The data byte is ignored.

When the maximum value or minimum value is reached, the value will not be incremented or decremented further.

(Incrementing the fine tune will not cause the coarse tune to be incremented.)

### 1.2.22 NRPN (Non-Registered Parameter Number) LSB (Control #098) NRPN (Non-Registered Parameter Number) MSB (Control #099)

Messages which adjust a voice's vibrato, filter, EG, drum setup or other parameter settings.

First send the NRPN MSB and NRPN LSB to specify the parameter which is to be controlled. Then use 1.2.4 Data Entry to set the value of the specified parameter.

Note that once the NRPN has been set for a channel, subsequent data entry will be recognized as the same NRPN's value change. Therefore, after you use the NRPN, you should set a Null (7FH, 7FH) value to avoid an unexpected result.

The following NRPN numbers can be received.

NRPN MSB	NRPN LSB	PARAMETER
01H	08H	Vibrato Rate
01H	09H	Vibrato Depth
01H	0AH	Vibrato Delay
01H	20H	Low Pass Filter Cutoff Frequency
01H	21H	Low Pass Filter Resonance
01H	24H	High Pass Filter Cutoff Frequency
01H	30H	EQ Bass Gain
01H	31H	EQ Treble Gain
01H	34H	EQ Bass Frequency
01H	35H	EQ Treble Frequency
01H	63H	EG Attack Time
01H	64H	EG Decay Time
01H	66H	EG Release Time
14H	rr	Drum Low Pass Filter Cutoff Frequency
15H	rr	Drum Low Pass Filter Resonance
16H	rr	Drum EG Attack Rate
17H	rr	Drum EG Decay Rate
18H	rr	Drum Instrument Pitch Coarse
19H	rr	Drum Instrument Pitch Fine
1AH	rr	Drum Instrument Level
1CH	rr	Drum Instrument Panpot
1DH	rr	Drum Instrument Reverb Send Level
1EH	rr	Drum Instrument Chorus Send Level
1FH	rr	Drum Instrument Variation Send Level
24H	rr	Drum High Pass Filter Cutoff Frequency
30H	rr	Drum EQ Bass Gain
31H	rr	Drum EQ Treble Gain
34H	rr	Drum EQ Bass Frequency
35H	rr	Drum EQ Treble Frequency

\*rr=Note number for each drum voice instrument.

### 1.2.23 RPN (Registered Parameter Number) LSB (Control #100)

### RPN (Registered Parameter Number) MSB (Control #101)

Messages which offset, or add or subtract values from a Part's pitch bend sensitivity, tuning, or other parameter settings.

First send the RPN MSB and RPN LSB to specify the parameter which is to be controlled. Then use 1.2.21 Data Increment/Decrement to set the value of the specified parameter.

Note that once the RPN has been set for a channel, subsequent data entry will be recognized as the same RPN's value change. Therefore after you use the RPN, you should set a Null (7FH, 7FH) value to avoid an unexpected result.

The following RPN numbers can be received.

RPN MSB	RPN LSB	PARAMETER
00H	00H	Pitch Bend Sensitivity
00H	01H	Fine Tune
00H	02H	Coarse Tune
7FH	7FH	Null

### 1.2.24 Channel Mode Messages

The following Channel Mode Messages can be received.

2nd BYTE	3rd BYTE	MESSAGE
120	0	All Sounds Off
121	0	Reset All Controllers
123	0	All Notes Off
126	0 ~ 16	Mono
127	0	Poly

#### 1.2.24.1 All Sounds Off (Control #120)

Clears all sounds currently sounding on the specified channel. However, the status of channel messages such as Note On and Hold On is maintained.

### 1.2.24.2 Reset All Controllers (Control #121)

The values of the following controllers will be reset to the defaults.

CONTROLLER	VALUE
Pitch Bend Change	0 (center)
Aftertouch	0 (off)
Modulation	0 (off)
Foot Controller	0 (min)
Expression	127 (max)
Hold1	0 (off)
Portamento	0 (off)*
Sostenuto	0 (off)
Soft Pedal	0 (off)
Portamento Control	Cancels the Portamento source key number
RPN	Number not specified; internal data will not change
NRPN	Number not specified; internal data will not change

\* In Performance mode, 1 (on).

### 1.2.24.3 All Notes Off (Control #123)

Clears all notes currently on for the specified channel. However, if Hold1 or Sostenuto is on, notes will continue sounding until these are turned off.

### 1.2.24.4 Mono (Control #126)

Performs the same function as when an All Sounds Off message is received, and if the 3rd byte (mono number) is in the range of 0 - 16, sets the corresponding channel to Mono Mode (Mode 4 : m = 1).

### 1.2.24.5 Poly (Control #127)

Performs the same function as when an All Sounds Off message is received, and sets the corresponding channel to Poly Mode (Mode 3).

## 1.3 Program Change

Messages which determine which voice to select for each Part. With a combination of Bank Select, you can select not only basic voice numbers, but also variation voice bank numbers.

## 1.4 Channel Aftertouch

Messages which let you control the sounds by the pressure you apply to the keys after the initial striking of the keys, over the entire channel.

## 1.5 Polyphonic Key Pressure

Messages which let you control the sounds by the pressure you apply to the keys after the initial striking of the keys, for each individual key.

## 1.6 Pitch Bend

Pitch Bend messages are continuous controller messages that allow the pitch of designated notes to be raised or lowered by a specified amount over a specified duration.

## 2. SYSTEM MESSAGES

System messages are the data related to the overall system of the device.

### 2.1 System Exclusive Messages

System Exclusive messages control various functions of the CS2x, including master volume and master tuning, tone generator mode, effect type and various other parameters.

#### 2.1.1 General MIDI Mode On

When General MIDI mode on is received, the tone generator mode will be changed to XG mode.

When this happens, the CS2x will receive the MIDI messages which are compatible with GM System Level 1, and consequently will not receive NRPN and Bank Select messages.

Since approximately 50ms is required to execute this message, be sure to leave an appropriate interval before the subsequent message.

F0 7E 7F 09 01 F7 (Hexadecimal)

#### 2.1.2 Master Volume

When received, the Volume MSB will be effective for the System Parameter.

F0 7F 7F 04 01 ll mm F7 (Hexadecimal)

\* mm(MSB) = appropriate volume value, ll(LSB) = ignored

#### 2.1.3 XG System On

When this data is received, the CS2x will switch to XG mode and all the parameters will be initialized accordingly, and XG-compatible messages such as NRPN and Bank Select messages can be received.

Since approximately 50ms is required to execute this message, be sure to leave an appropriate interval before the subsequent message.

F0 43 1n 4C 00 00 7E 00 F7 (Hexadecimal)

\*n = device number

TG300B Reset

F0 41 1n 42 12 40 00 7F 00 41 F7 (Hexadecimal)

\*n = device number

#### 2.1.4 Performance Mode On

F0 43 1n 63 50 00 06 03 F7 (Hexadecimal)

\*n = device number

### 2.2 Active Sensing

Once FE (Active Sensing) has been received, if no MIDI data is subsequently received for longer than an interval of approximately 300msec, the CS2x will perform the same function as when All Sounds Off, All Notes Off, and Reset All Controllers messages are received, and will then return to a status in which FE is not monitored.

Refer to the MIDI Data Format in the "Data List" book for more information on the various messages.

# Specifications

<b>KEYBOARD</b>	61 keys with Initial Touch		
<b>TONE GENERATOR</b>	AWM2 (Wave ROM 16MB)		
<b>POLYPHONY</b>	64 notes		
<b>MULTI TIMBRE</b>	16 (DVA)		
<b>PERFORMANCE</b>	256 Presets, 256 Users		
<b>VOICE</b>	Normal Voices	Total	779
		XG	586
		TG300B	614
	Voices For Performances		
	Drum Voices	Total	30
		XG	20
TG300B		10	
<b>ARPEGGIATOR</b>	40		
<b>EFFECT</b>	Reverb	12	
	Chorus	14	
	Variation	62	
<b>CONTROLS</b>	STANDBY/ON, VOLUME, PITCH, MODULATION, Sound Control Knobs 8, SCENE 1/2, Numeric Keypad, ENTER, Mode Select (PERFORMANCE, MULTI, STORE, UTILITY), ARPEGGIATOR, SHIFT/OCTAVE, PART/LAYER +/-, PRESET, USER, PROGRAM +/-, Edit Parameter Rotary Switch, Parameter Value Up/Down buttons 10		
<b>DISPLAY</b>	LCD (Back Lit)		
<b>TERMINALS</b>	PHONES (Stereo Phone), OUTPUT (Phone): L[MONO]/R, DC IN, FOOT VOLUME, FOOT CONTROLLER, FOOTSWITCH, INPUT, TO HOST, HOST SELECT, MIDI IN/OUT/THRU		
<b>POWER SUPPLY</b>	AC adaptor PA-3B*		
<b>DIMENSIONS</b>	976(W) x 285(D) x 103(H)mm (38-3/8" x 11-1/4" x 4-1/16")		
<b>WEIGHT</b>	5.7kg (12 lbs., 9 oz.)		
<b>ACCESSORIES</b>	Yamaha AC Adaptor PA-3B*		
	Owner's Manual, Data List		

Specifications and descriptions in this owner's manual are for information purposes only. Yamaha Corp. reserves the right to change or modify products or specifications at any time without prior notice. Since specifications, equipment or options may not be the same in every locale, please check with your Yamaha dealer.

\* Power supply recommendation may vary from country to country. Please check with your nearest Yamaha dealer for further details.

# Troubleshooting

The following table provides troubleshooting hints and page references for some common problems. Most problems may be simply the result of incorrect settings. Before calling for professional service, refer to the troubleshooting advice below to see if you can find and correct the cause of the problem.

## No sound.

- Is the volume set appropriately? (page 8)
- When the Foot Controller is connected to the FOOT VOLUME jack, is the Foot Volume pressed down? (page 10)
- Are the volume settings for each Layer/Part appropriate? (page 54, 59)
- Are the effect settings appropriate? (page 44, 70)
- Is the Bank set to off? (page 54, 58)
- Is the receive channel set to off? (page 63)
- Is the audio equipment connected appropriately? (page 11)
- Is Local set to off? (page 63)
- If you are playing back song data using an external device, are the volume related settings for the song appropriate?
- Are the Note Limit settings and/or Velocity Limit settings appropriate? (page 48)

## No Arpeggiator sound.

- Are the settings for the Velocity Limit appropriate? Set Velocity Limit Low to "0" and Velocity Limit Hi to "127". (page 48)

## Distorted sounds.

- Are the effect settings appropriate? (page 44, 55, 59, 70)
- Is the volume level set too loud?

## Small sounds.

- Is the MIDI volume or MIDI expression set too low?

## Wrong pitch.

- Are the tuning-related parameters set to "0"? Check the Note Shift setting (page 48), Detune setting (page 48), Master Tuning (page 61) and Keyboard Transpose setting (page 62).

## Sound is choppy and interrupted.

- The maximum polyphony of 64 notes (the number of notes that can be played simultaneously) has been exceeded. (page 56, 60)

## Sound Control Knobs do not work.

- Is a Scene key turned on? (page 25)

## Only one note sounds at a time.

- Is the play mode set to MONO? (page 56, 60)

## Cannot enter Store mode.

- Is Performance mode or Multi Play mode selected? (page 40, 57)

# ***Error Messages***

The following messages may appear during operation, indicating problems or incorrect operation. Follow the instructions in the explanations below to remedy the problem.

## **Battery Low**

The memory-backup battery is low; memory cannot be backed up. Store the necessary data to a MIDI data storage device such as Yamaha MIDI Data Filer MDF3, and have the battery changed by your local Yamaha dealer or any other authorized Yamaha service personnel.

## **Device No.=off Error**

Cannot send MIDI bulk data since the Device Number is set to off.

## **Device Number Error**

Cannot receive MIDI bulk data, due to improper Device Number setting. Match the device numbers for both the CS2x and the external device.

## **TG-B Mode Error**

When TG300B mode is accidentally selected by receiving a TG300B reset message from an external device, you cannot perform edit operations. Press PERFORMANCE or MULTI button to exit the TG300B mode.

## **Receiving**

Displays when the CS2x receives the bulk data with the compatible format. Continue normal operation.

## **Rx Mode Error**

Displays when receiving Performance bulk data in Multi Play mode or XG effect bulk in Performance mode.

# Index

[-/NO/QUICK PC] button .....9

## A

About MIDI .....72  
 AEG (Amplitude Envelope Generator) .....50  
 Arpeggiator .....27, 43  
 [ARPEGGIO] button .....8  
 ASSIGN CTRL NO (Assign Control Number) .....64  
 ASSIGN1 PARAM (ASSIGN1 Parameter) .....47  
 ASSIGN2 .....49

## B

BANK .....54  
 BULK DUMP .....64

## C

Category Codes .....24  
 Common Edit 1 .....43  
 Common Edit 2 .....45

## D

DC IN terminal .....10  
 DEMO function .....9  
 Demo Songs .....14  
 DEVICE NO (Device Number) .....63  
 Drum Voices .....18, 59

## E

EDIT PARAMETER ROTARY switch .....9  
 Edit Parameters .....20  
 EFFECT .....44, 55, 59  
 Effects .....70  
 [ENTER/YES] button .....9  
 Error Messages .....78

## F

Factory Settings .....69  
 FC (Foot Control) .....46  
 FEG (Filter Envelope Generator) .....52  
 FILTER .....55, 60  
 Foot Controller .....12  
 FOOT CONTROLLER jack .....10  
 FOOT VOLUME jack .....10  
 FOOTSWITCH jack .....10

## G

General MIDI .....33

## H

HOST SELECT switch .....10

## I

INPUT jack .....10

## K

KBD TRANS (Keyboard Transpose) .....62  
 Keyboard .....9

## L

LAYER .....29  
 Layer Edit 1 .....47  
 Layer Edit 2 .....50  
 Layer Edit 3 .....52  
 Layer Edit 4 .....54  
 Layers .....18  
 LCD .....8  
 LFO (Low Frequency Oscillator) .....51  
 LOCAL .....63

## M

Main Features .....7  
 MASTER TUNE .....61  
 MIDI .....63  
 MIDI terminals .....10  
 MODULATION wheel .....9, 25  
 [MULTI] button .....9  
 Mult Store .....68  
 Multi Part Edit .....57  
 Multi Play In Performance Mode .....33, 56  
 Multi Play Mode .....22, 31, 57  
 MW (Modulation Wheel) .....46

## N

Normal Voices .....18, 59  
 NOTE .....48  
 NUMERIC KEYPAD .....9, 24

## O

Octave Shift Function .....25  
 OUTPUT jacks .....10

## P

P BEND RANGE .....45  
 PAN .....54, 59  
 Parameter Value [UP/DOWN] buttons .....9  
 Part Assign .....32  
 PART/LAYER/OCTAVE [-]/[+] buttons .....8  
 PEG (Pitch Envelope Generator) .....53  
 PERFORM LEVEL .....44  
 PERFORM NAME .....45  
 [PERFORMANCE] button .....9  
 Performance Edit Mode .....21, 41  
 Performance Mode .....23, 40  
 Performance Modes .....21  
 Performance Play Mode .....21, 40  
 Performance Store .....30  
 PHONES jack .....10  
 PITCH wheel .....9, 25  
 POLY/MONO .....56, 60  
 PORTA (Portamento) .....47  
 [PRESET] button .....8  
 PROGRAM .....54, 59  
 PROGRAM [-]/[+] buttons .....8

## Q

Quick Program Change .....41  
 Quick Tour .....23

## R

RCV CH (Receive Channel) .....63

## S

[SCENE] buttons .....8  
 SCENE CONTROL Function .....25, 26  
 Scene Store .....67  
 Scenes .....25  
 [SHIFT] button .....8  
 SOUND CONTROL knobs .....8, 19, 26, 65  
 STANDBY/ON switch .....10  
 [STORE] button .....9  
 Store Mode .....22, 66  
 SYSTEM .....61

## T

TG300B Mode .....59  
 TO HOST terminal .....10  
 TRANS CH (Transmit Channel) .....63  
 TUNE .....48

## U

[USER] button .....8  
 [UTILITY] button .....9  
 Utility Mode .....22, 61

## V

VEL (Velocity) .....48  
 VEL CURVE (Velocity Curve) .....62  
 VEL FIX (Velocity Fix) .....62  
 VOLUME .....54, 59

## X

XG Operation .....33  
 XGworks .....34

# MEMO



For details of products, please contact your nearest Yamaha or the authorized distributor listed below.

Pour plus de détails sur les produits, veuillez-vous adresser à Yamaha ou au distributeur le plus proche de vous figurant dans la liste suivante.

Die Einzelheiten zu Produkten sind bei Ihrer unten aufgeführten Niederlassung und bei Yamaha Vertragshändlern in den jeweiligen Bestimmungsländern erhältlich.

Para detalles sobre productos, contacte su tienda Yamaha más cercana o el distribuidor autorizado que se lista debajo.

## NORTH AMERICA

### CANADA

**Yamaha Canada Music Ltd.**  
135 Milner Avenue, Scarborough, Ontario,  
M1S 3R1, Canada  
Tel: 416-298-1311

### U.S.A.

**Yamaha Corporation of America**  
6600 Orangethorpe Ave., Buena Park, Calif. 90620,  
U.S.A.  
Tel: 714-522-9011

## CENTRAL & SOUTH AMERICA

### MEXICO

**Yamaha de Mexico S.A. De C.V.,  
Departamento de ventas**  
Javier Rojo Gomez No.1149, Col. Gpe Del  
Moral, Deleg. Iztapalapa, 09300 Mexico, D.F.  
Tel: 686-00-33

### BRAZIL

**Yamaha Musical do Brasil LTDA.**  
Av. Rebouças 2636, São Paulo, Brasil  
Tel: 011-853-1377

### ARGENTINA

**Yamaha Music Argentina S.A.**  
Viamonte 1145 Piso2-B 1053,  
Buenos Aires, Argentina  
Tel: 1-371-7021

### PANAMA AND OTHER LATIN AMERICAN COUNTRIES/ CARIBBEAN COUNTRIES

**Yamaha de Panama S.A.**  
Torre Banco General, Piso 7, Urbanización Marbella,  
Calle 47 y Aquilino de la Guardia,  
Ciudad de Panamá, Panamá  
Tel: 507-269-5311

## EUROPE

### THE UNITED KINGDOM

**Yamaha-Kemble Music (U.K.) Ltd.**  
Sherbourne Drive, Tilbrook, Milton Keynes,  
MK7 8BL, England  
Tel: 01908-366700

### IRELAND

**Danfay Ltd.**  
61D, Sallynoggin Road, Dun Laoghaire, Co. Dublin  
Tel: 01-2859177

### GERMANY/SWITZERLAND

**Yamaha Europa GmbH.**  
Siemensstraße 22-34, 25462 Rellingen,  
F.R. of Germany  
Tel: 04101-3030

### AUSTRIA

**Yamaha Music Austria**  
Schleiergasse 20, A-1100 Wien Austria  
Tel: 01-60203900

### THE NETHERLANDS

**Yamaha Music Nederland**  
Kanaalweg 18G, 3526KL, Utrecht, The Netherlands  
Tel: 030-2828411

### BELGIUM

**Yamaha Music Belgium**  
Keiberg Imperiastraat 8, 1930 Zaventem, Belgium  
Tel: 02-7258220

### FRANCE

**Yamaha Musique France,  
Division Professionnelle**  
BP 70-77312 Marne-la-Vallée Cedex 2, France  
Tel: 01-64-61-4000

## ITALY

**Yamaha Musica Italia S.P.A.,  
Combo Division**  
Viale Italia 88, 20020 Lainate (Milano), Italy  
Tel: 02-935-771

## SPAIN/PORTUGAL

**Yamaha-Hazen Electronica Musical, S.A.**  
Jorge Juan 30, 28001, Madrid, Spain  
Tel: 91-577-7270

## GREECE

**Philippe Nakas S.A.**  
Navarinou Street 13, P.Code 10680, Athens, Greece  
Tel: 01-364-7111

## SWEDEN

**Yamaha Scandinavia AB**  
J.A. Wettergrens Gata 1  
Box 30053  
S-400 43 Göteborg, Sweden  
Tel: 031 89 34 00

## DENMARK

**YS Copenhagen Liaison Office**  
Generatørvej 8B  
DK-2730 Herlev, Denmark  
Tel: 44 92 49 00

## FINLAND

**Warner Music Finland OY/Fazer Music**  
Aleksanterinkatu 11, P.O. Box 260  
SF-00101 Helsinki, Finland  
Tel: 0435 011

## NORWAY

**Norsk filial av Yamaha Scandinavia AB**  
Grini Næringspark 1  
N-1345 Østerås, Norway  
Tel: 67 16 77 70

## ICELAND

**Skifan HF**  
Skeifán 17 P.O. Box 8120  
IS-128 Reykjavik, Iceland  
Tel: 525 5000

## OTHER EUROPEAN COUNTRIES

**Yamaha Europa GmbH.**  
Siemensstraße 22-34, 25462 Rellingen, F.R. of  
Germany  
Tel: 04101-3030

## AFRICA

**Yamaha Corporation,  
International Marketing Division**  
Nakazawa-cho 10-1, Hamamatsu, Japan 430-8650  
Tel: 053-460-2312

## MIDDLE EAST

### TURKEY/CYPRUS

**Yamaha Europa GmbH.**  
Siemensstraße 22-34, 25462 Rellingen,  
F.R. of Germany  
Tel: 04101-3030

### OTHER COUNTRIES

**Yamaha Corporation,  
International Marketing Division**  
Nakazawa-cho 10-1, Hamamatsu, Japan 430-8650  
Tel: 053-460-2312

## ASIA

### HONG KONG

**Tom Lee Music Co., Ltd.**  
11/F, Silvercord Tower 1, 30 Canton Road,  
Tsimshatsui, Kowloon, Hong Kong  
Tel: 2737-7688

### INDONESIA

**PT. Yamaha Music Indonesia (Distributor)  
PT. Nusantik**  
Gedung Yamaha Music Center, Jalan Jend. Gatot  
Subroto Kav. 4, Jakarta 12930, Indonesia  
Tel: 21-520-2577

### KOREA

**Cosmos Corporation**  
#131-31, Neung-Dong, Sungdong-Ku, Seoul  
Korea  
Tel: 02-466-0021~5

### MALAYSIA

**Yamaha Music Malaysia, Sdn., Bhd.**  
Lot 8, Jalan Perbandaran, 47301 Kelana Jaya,  
Petaling Jaya, Selangor, Malaysia  
Tel: 3-703-0900

### PHILIPPINES

**Yupango Music Corporation**  
339 Gil J. Puyat Avenue, P.O. Box 885 MCPO,  
Makati, Metro Manila, Philippines  
Tel: 819-7551

### SINGAPORE

**Yamaha Music Asia Pte., Ltd.**  
Blk 202 Hougang, Street 21 #02-01,  
Singapore 530202  
Tel: 747-4374

### TAIWAN

**Yamaha KHS Music Co., Ltd.**  
10F 150, Tun-Hwa Northroad,  
Taipei, Taiwan, R.O.C.  
Tel: 02-2713-8999

### THAILAND

**Siam Music Yamaha Co., Ltd.**  
121/60-61 RS Tower 17th Floor,  
Ratchadaphisek RD., Dindaeng,  
Bangkok 10320, Thailand  
Tel: 02-641-2951

### THE PEOPLE'S REPUBLIC OF CHINA AND OTHER ASIAN COUNTRIES

**Yamaha Corporation,  
International Marketing Division**  
Nakazawa-cho 10-1, Hamamatsu, Japan 430-8650  
Tel: 053-460-2317

## OCEANIA

### AUSTRALIA

**Yamaha Music Australia Pty. Ltd.**  
17-33 Market Street, South Melbourne, Vic. 3205,  
Australia  
Tel: 3-699-2388

### NEW ZEALAND

**Music Houses of N.Z. Ltd.**  
146/148 Captain Springs Road, Te Papapa, Auckland,  
New Zealand  
Tel: 9-634-0099

### COUNTRIES AND TRUST TERRITORIES IN PACIFIC OCEAN

**Yamaha Corporation,  
International Marketing Division**  
Nakazawa-cho 10-1, Hamamatsu, Japan 430-8650  
Tel: 053-460-23170

## HEAD OFFICE

**Yamaha Corporation, Electronic Musical Instrument Division**  
Nakazawa-cho 10-1, Hamamatsu, Japan 430-8650  
Tel: 053-460-2445

# FCC INFORMATION (U.S.A.)

## 1. IMPORTANT NOTICE: DO NOT MODIFY THIS UNIT!

This product, when installed as indicated in the instructions contained in this manual, meets FCC requirements. Modifications not expressly approved by Yamaha may void your authority, granted by the FCC, to use the product.

**2. IMPORTANT:** When connecting this product to accessories and/or another product use only high quality shielded cables. Cable/s supplied with this product MUST be used. Follow all installation instructions. Failure to follow instructions could void your FCC authorization to use this product in the USA.

**3. NOTE:** This product has been tested and found to comply with the requirements listed in FCC Regulations, Part 15 for Class "B" digital devices. Compliance with these requirements provides a reasonable level of assurance that your use of this product in a residential environment will not result in harmful interference with other electronic devices. This equipment generates/uses radio frequencies and, if not installed and used according to the instructions found in the users manual, may cause interference harmful to the operation of other electronic devices. Compliance with FCC regulations does not guarantee that interference will not occur in all installations. If this

product is found to be the source of interference, which can be determined by turning the unit "OFF" and "ON", please try to eliminate the problem by using one of the following measures:

Relocate either this product or the device that is being affected by the interference.

Utilize power outlets that are on different branch (circuit breaker or fuse) circuits or install AC line filter/s.

In the case of radio or TV interference, relocate/reorient the antenna. If the antenna lead-in is 300 ohm ribbon lead, change the lead-in to co-axial type cable.

If these corrective measures do not produce satisfactory results, please contact the local retailer authorized to distribute this type of product. If you can not locate the appropriate retailer, please contact Yamaha Corporation of America, Electronic Service Division, 6600 Orangethorpe Ave, Buena Park, CA90620

The above statements apply ONLY to those products distributed by Yamaha Corporation of America or its subsidiaries.

\* The above statements apply ONLY to those products distributed by Yamaha Corporation of America or its subsidiaries.

## ADVARSEL!

Lithiumbatteri—Eksplussionsfare ved fejlagtig håndtering. Udskiftning må kun ske med batteri af samme fabrikat og type. Levér det brugte batteri tilbage til leverandoren.

## VARNING

Explosionsfara vid felaktigt batteribyte. Använd samma batterityp eller en ekvivalent typ som rekommenderas av apparattillverkaren. Kassera använt batteri enligt fabrikantens instruktion.

## VAROITUS

Paristo voi räjähtää, jos se on virheellisesti asennettu. Vaihda paristo ainoastaan laitevalmistajan suosittelemaan tyyppiin. Hävitä käytetty paristo valmistajan ohjeiden mukaisesti.

## NEDERLAND / THE NETHERLANDS

- Dit apparaat bevat een lithium batterij voor geheugen back-up.
- This apparatus contains a lithium battery for memory back-up.
- Raadpleeg uw leverancier over de verwijdering van de batterij op het moment dat u het apparaat aan het einde van de levensduur afdankt of de volgende Yamaha Service Afdeling:  
Yamaha Music Nederland Service Afdeling  
Kanaalweg 18-G, 3526 KL UTRECHT  
Tel. 030-2828425
- For the removal of the battery at the moment of the disposal at the end of the service life please consult your retailer or Yamaha Service Center as follows:  
Yamaha Music Nederland Service Center  
Address : Kanaalweg 18-G, 3526 KL UTRECHT  
Tel : 030-2828425
- Gooi de batterij niet weg, maar lever hem in als KCA.
- Do not throw away the battery. Instead, hand it in as small chemical waste.



# SAMPLING UNIT

# SU700

Cutting-edge groove machine unites sampling, sequencing, effects and mixing. A unique tool for recording artists, DJs, dance music producers, and all others who need to create and perform dynamic sample-based sequences.



## Specifications

<b>SEQUENCER</b> Memory Resolution Tempo Recording Mode Tracks Songs Sync Modes	32,000 notes (no backup) 1 / 480 40.0 to 299.9 Realtime 42 (10 x 4 banks, plus AUDIO IN and MASTER) 20 MTC, MIDI	<b>USER INTERFACE</b> Display Controls	Custom VFD (16 characters and 4-color segments) 12 track pads (8 velocity-sensitive pads) 12 realtime control knobs Assignable ribbon controller
<b>TONE GENERATOR</b> Type Polyphony Data formats Signal Processing  Sampling Wave Memory Multi-Effector	AWM2 Max 64 notes 16-bit linear, 8-bit linear Stereo Sampling 16-bit A/D, 18-bit D/A 4MB standard (expandable to 68MB) Three units, configurable. (Also operates on analog input)	<b>CONNECTORS</b>	Line Out : L/MONO, R (1/4" phone) Line In / Mic In : 1/4" phone Stereo Headphones : 1/4" phone MIDI : IN, OUT AC Inlet
<b>DATA STORAGE</b> Internal FDD	2HD/2DD, for songs and sampling data Optional support for external SCSI disk	<b>OPTIONS</b> Wave Memory SCSI Board Input/Output	72-pin SIMM (4, 8, 16, or 32 MB) x 2 ASIB1 (Same board supported by the EX series) AEIB1 board; provides assignable outputs and digital I/O (Same board supported by the A3000)
<b>SIZE, WEIGHT</b> Size (W x D x H) Weight		363 x 310 x 115 mm 6 kg (13.2 lb)	

Specifications and appearance are subject to change without notice.

# RM1x

## SEQUENCE REMIXER

An Inspired Sequence Remix Workstation  
for Performance & Production



- An extensive arsenal of 700 outstanding dance-oriented sounds.
- An awesome assortment of 50 preset styles, 960 patterns and 7,726 phrases.
- 8 assignable real-time control knobs, a large LCD display panel with 4 display knobs and a large multi-function keyboard.
- Each “style” has up to 16 “sections” which can be switched in real time during playback via the RM1x keyboard.
- In-depth sequence editing functions make it possible to create and refine complex patterns and musical textures with extraordinary precision.
- Edit and refine the RM1x voices to create sounds that most ideally suit your own music.
- A sophisticated multi-effect system can be used to add anything from subtle ambience to wild variations.
- Realtime “Play Effects” including harmonize with unison and octave functions, beat stretch, clock shift, gate time, and velocity offset.
- Built-in floppy disk drive for convenient, low cost data storage and retrieval.
- Full MIDI compatibility.

### ■ Specifications

#### Sequencer

MEMORY CAPACITY	110,000 notes
TIMING RESOLUTION	1/480 quarter-note
POLYPHONY	Maximum 64 simultaneous notes
TEMPO	25.0-300.0
RECORDING METHODS	Realtime (Replace, Overdub, Punch-in), Step, Grid Step
SEQUENCER TRACKS	16 tracks
TRACKS PER PATTERN	16 tracks
PRESET PATTERNS	960 (60 styles x 16 sections)
USER PATTERNS	800 (50 styles x 16 sections)
PRESET PHRASES	7,726
USER PHRASES PER STYLE	256
PATTERN CHAINS	20 songs
SONGS	20 songs
EDIT	Song edit, Phrase edit
JOBS	36 pattern jobs, 8 pattern chain jobs, 28 song jobs
SPLIT	Split song, Split pattern
GROOVES	Grid Grooves (Note Offset, Clock Shift, Gatetime Offset, Velocity Offset)
PLAY EFFECTS	Play Effects (Beat Stretch, Clock Shift, Gatetime, Velocity Offset) Harmonize (Unison, Octave, Harmonize 1, Harmonize 2)
MIDI DELAY	MIDI Delay edit, Feedback edit
ARPEGGIOS	Type (Up, Down, Alternate 1, Alternate 2, Random), Sort, Hold, Octave Range
SEQUENCE FORMATS	RM1x format, SMF (Format 0)

#### Tone Generator

TONE GENERATION	AWM2
POLYPHONY	Maximum 32 simultaneous notes
MULTI-TIMBRAL	Maximum 16 timbres (last-note priority with element reserve, DVA)
PRESET VOICES	654 normal voices, 46 drum-kit voices(excl. GM normal voices and GM drum-kit voices)
EFFECTS	11 Reverb types, 11 Chorus types, 43 Variations
DIGITAL LOW BOOST	±24dB/50Hz-2.0kHz